

2024

Rules for the Classification of Steel Ships

Part 8 Fire Protection and Fire Extinction

---

---

Rules

2024

Guidance Relating to the Rules for the Classification of Steel ships

Part 8 Fire Protection and Fire Extinction

---

---

Guidance



2024

Rules for the Classification of Steel Ships

---

Part 8

Fire Protection and Fire Extinction

---

**APPLICATION OF  
PART 8 "FIRE PROTECTION AND FIRE EXTINCTION"**

1. Unless expressly specified otherwise, the requirements in this Rules apply to ships for which constructed on or after 1 July 2024.
2. The amendments to the Rules for 2023 edition and their effective date are as follows;

Effective Date: 1 July 2024

---

**< No revision >**

# CONTENTS

<b>CHAPTER 1 GENERAL</b> .....	<b>1</b>
Section 1 General .....	1
<b>CHAPTER 2 PROBABILITY OF IGNITION</b> .....	<b>7</b>
Section 1 Arrangements for Oil Fuel, Lubrication Oil and Other Flammable Oils .....	7
Section 2 Arrangements for Gaseous Fuel for Domestic Purpose .....	10
Section 3 Miscellaneous Items of Ignition Sources and Ignitability .....	10
Section 4 Cargo Areas of Tankers .....	10
<b>CHAPTER 3 FIRE GROWTH POTENTIAL</b> .....	<b>17</b>
Section 1 Control of Air Supply and Flammable Liquid to The Spaces .....	17
Section 2 Fire Protection Materials .....	18
<b>CHAPTER 4 SMOKE GENERATION POTENTIAL AND TOXICITY</b> .....	<b>21</b>
Section 1 Paints, Varnishes and Other Finishes .....	21
Section 2 Primary Deck Coverings .....	21
<b>CHAPTER 5 DETECTION AND ALARM</b> .....	<b>23</b>
Section 1 General .....	23
Section 2 Protection of Machinery Spaces .....	23
Section 3 Protection of Accommodation and Service Spaces and Control Stations .....	24
Section 4 Protection of Cargo Spaces in Passenger Ships .....	25
Section 5 Manually Operated Call Points .....	25
Section 6 Fire Patrols in Passenger Ships .....	25
Section 7 Fire Alarm Signalling Systems in Passenger Ships .....	26
Section 8 Protection of cabin balconies on passenger ships .....	26
<b>CHAPTER 6 CONTROL OF SMOKE SPEED</b> .....	<b>27</b>
Section 1 Protection of Control Stations Outside Machinery Space .....	27
Section 2 Release of Smoke from Machinery Spaces .....	27
Section 3 Draft Stops .....	27
Section 4 Smoke Extraction Systems in Atriums of Passenger Ships .....	27
<b>CHAPTER 7 CONTAINMENT OF FIRE</b> .....	<b>29</b>
Section 1 Thermal and Structural Boundaries .....	29
Section 2 Penetration in Fire-resisting Divisions and Prevention of Heat Transmission .....	42
Section 3 Protection of Openings in Fire-resisting Divisions .....	43

Section 4	Protection of Openings In Machinery Space Boundaries .....	46
Section 5	Protection of Cargo Space Boundaries .....	46
Section 6	Ventilation Systems .....	47
<b>CHAPTER 8</b>	<b>FIRE FIGHTING .....</b>	<b>51</b>
Section 1	Water Supply System .....	51
Section 2	Portable Fire Extinguisher .....	55
Section 3	Fixed Fire-extinguishing Systems .....	55
Section 4	Fire Extinguishing Arrangements In Machinery Spaces .....	56
Section 5	Fire-extinguishing Arrangements In Control Stations, Accommodation and Service Spaces .....	58
Section 6	Fire-extinguishing Arrangements In Cargo Spaces .....	59
Section 7	Cargo Tank Protection .....	60
Section 8	Protection of Cargo Pump Room .....	60
Section 9	Fire-fighter's Outfit .....	61
<b>CHAPTER 9</b>	<b>STRUCTURAL INTEGRITY .....</b>	<b>63</b>
Section 1	Material .....	63
Section 2	Structure of aluminium alloy .....	63
Section 3	Machinery Spaces of Category A .....	63
Section 4	Materials of Overboard Fittings .....	63
Section 5	Protection of Cargo Tank Structure Against Pressure Or Vacuum In Tankers .....	64
<b>CHAPTER 10</b>	<b>ESCAPE .....</b>	<b>67</b>
Section 1	Notification of crew and passengers .....	67
Section 2	Means of escape .....	67
<b>CHAPTER 11</b>	<b>HELICOPTER FACILITIES .....</b>	<b>73</b>
Section 1	Application .....	73
Section 2	Structure .....	73
Section 3	Means of Escape .....	73
Section 4	Fire-fighting Appliances .....	73
Section 5	Drainage Facilities .....	74
Section 6	Helicopter Refueling and Hanger Facilities .....	74
Section 7	Operations Manual and Fire- fighting Service .....	75
<b>CHAPTER 12</b>	<b>CARRIAGE OF DANGEROUS GOODS .....</b>	<b>77</b>
Section 1	General Requirements .....	77
Section 2	Special Requirements .....	77
Section 3	Document of Compliance .....	82

<b>CHAPTER 13</b>	<b>PROTECTION OF VEHICLE, SPECIAL CATEGORY AND RO-RO SPACES</b>	<b>83</b>
Section 1	General Requirements	83
Section 2	Precaution against ignition of flammable vapours in closed vehicle spaces closed ro-ro spaces and special category spaces	83
Section 3	Detection and alarm	85
Section 4	Structure protection	85
Section 5	Fire-extinction	85
Section 6	Requirements for vehicle carriers carrying motor vehicles with compressed hydrogen or natural gas in their tanks for their own propulsion as cargo	87
<b>CHAPTER 14</b>	<b>SAFETY RETURN TO PORT SYSTEM ON PASSENGER SHIPS</b>	<b>89</b>
Section 1	General	89

## CHAPTER 1 GENERAL

### Section 1 General

#### 101. Application [See Guidance]

1. Unless expressly specified otherwise, where ships not less than 500 tons gross tonnage and Passengers ships are engaged in international voyage, those construction of fire protection, fire detection and fire extinction shall be complied with the requirements of this Part. However, for cargo ships less than 500 tons gross tonnage or cargo ships not engaged international voyage or fishing vessels they may approve relaxations from the requirements in accordance with **the Guidance** as provided separately.
2. In addition to para 1 they shall also be complied with the International Conventions of SOLAS and the National Regulations of the country in which the ships is registered.
3. Despite of para 1 and 2 for the ships not applied to the SOLAS but applied to the Ships Safety Law or Fishing vessel Law of Korea those fire-fighting system shall be in accordance with the relevant requirements specified by these Laws.

#### 4. Application of requirements for tankers (2020)

- (1) Requirements for tankers in this part shall apply to tankers carrying crude oil or petroleum products having a flashpoint not exceeding 60°C (closed cup test), as determined by an approved flashpoint apparatus, and a Reid vapour pressure which is below the atmospheric pressure or other liquid products having a similar fire hazard.
- (2) Where liquid cargoes other than those referred to in (1) above or liquefied gases which introduce additional fire hazards are intended to be carried, additional safety measures shall be required, having due regard to the provisions of the IBC Code, the BC Code, the IGC Code, and the GC Code, as appropriate.
  - (A) A liquid cargo with a flashpoint of less than 60 °C for which a regular foam fire-fighting system complying with the FSS Code is not effective, is considered to be a cargo introducing additional fire hazards in this context. The following additional measures are required:
    - (a) the foam shall be of alcohol resistant type;
    - (b) the type of foam concentrates for use in chemical tankers are to be to the satisfaction of the Society taking into account the guidelines developed by the IMO;
    - (c) the capacity and application rates of the foam extinguishing system shall comply with chapter 11 of the IBC Code, except that lower application rates may be accepted based on performance tests. For tankers fitted with inert gas systems, a quantity of foam concentrate sufficient for 20 min of foam generation may be accepted.
  - (B) For the purpose of this regulation, a liquid cargo with a vapour pressure greater than 1.013 bar absolute at 37.8 °C is considered to be a cargo introducing additional fire hazards. Ships carrying such substances shall comply with the requirements of the IBC Code. When ships operate in restricted areas and at restricted times, the Society concerned may agree to waive the requirements for refrigeration systems in accordance with requirements of the IBC Code.
- (3) Liquid cargoes with a flashpoint exceeding 60 °C other than oil products or liquid cargoes subject to the requirements of the IBC Code are considered to constitute a low fire risk, not requiring the protection of a fixed foam extinguishing system.
- (4) Tankers carrying petroleum products with a flashpoint exceeding 60 °C (closed cup test), as determined by an approved flashpoint apparatus, shall comply with the requirements provided in **Ch 8, 101. 4 (4)** and **Ch 8, 902. 3.** and the requirements for cargo ships other than tankers, except that, in lieu of the fixed fire extinguishing system required in **Ch 8, Sec.6,** they shall be fitted with a fixed deck foam system which shall comply with the provisions of the FSS Code.
- (5) Combination carriers shall not carry cargoes other than oil unless all cargo spaces are empty of oil and gas-freed or unless the arrangements provided in each case have been approved by the Society taking into account the guidelines developed by the IMO.
- (6) Chemical tankers and gas carriers shall comply with the requirements for tankers, except where alternative and supplementary arrangements are provided to the satisfaction of the Society, hav-

ing due regard to the provisions of the IBC Code and the IGC Code, as appropriate.

### 102. Plans and documents

1. The following plans and documents are to be submitted to the Society for approval before the work is commenced.
  - (1) Plans of construction for fire protection (details of construction for fire protection and arrangements of closing appliances of openings, etc.)
  - (2) Plans for details of escape route and width of escape route, etc. (Calculation method of stairway width for Passenger ships)
  - (3) Plans of fire control plan showing clearly for each deck the control station, the various fire section enclosed by "A" class divisions, the sections enclosed by "B" class divisions together with particulars of the fire detection and fire alarm systems, the sprinkler installations, the fire-extinguishing appliances, means of access to different compartments, decks, etc., and the ventilating system including particulars of the fan control positions, the position of dampers and identification numbers of the ventilating fan serving each section. **【See Guidance】**
  - (4) Other plans and documents deemed necessary by the Society. **【See Guidance】**

### 103. Definitions

1. **Accommodation spaces** are those spaces used for public spaces, corridors, lavatories, cabins, offices, hospitals, cinemas, game and hobby rooms, barber shops, pantries containing no cooking appliances and similar spaces. **【See Guidance】**
2. **"A" class divisions** are those divisions formed by bulkheads and decks which comply with the following criteria. **【See Guidance】**

- (1) they are constructed of steel or other equivalent material;
- (2) they are suitably stiffened;
- (3) they are insulated with approved non-combustible materials such that the average temperature of the unexposed side will not rise more than 140 °C above the original temperature, nor will the temperature, at any one point, including any joint, rise more than 180 °C above the original temperature, within the time listed below:

class "A-60" 60 min	class "A-30" 30 min	class "A-15" 15 min	class "A-0" 0 min
---------------------	---------------------	---------------------	-------------------

- (4) they are constructed as to be capable of preventing the passage of smoke and flame to the end of the one-hour standard fire test; and
- (5) the Society has required a test of a prototype bulkhead or deck in accordance with the Fire Test Procedures Code to ensure that it meets the requirements above for integrity and temperature rise.

3. **Atriums** are public spaces within a single main vertical zone spanning three or more open decks.
4. **"B" class divisions** are those divisions formed by bulkheads, decks, ceilings or linings which comply with the following criteria:

- (1) they are constructed of approved non-combustible materials and all materials used in the construction and erection of "B" class divisions are non-combustible, with the exception that combustible veneers may be permitted provided they meet other appropriate requirements of this chapter;
- (2) they have an insulation value such that the average temperature of the unexposed side will not rise more than 140 °C above the original temperature, nor will the temperature at any one point, including any joint, rise more than 225 °C above the original temperature, within the time listed below:

class "B-15" 15 min	class "B-0" 0 min
---------------------	-------------------

- (3) they are constructed as to be capable of preventing the passage of flame to the end of the first half hour of the standard fire test; and
- (4) the Society has required a test of a prototype division in accordance with the Fire Test Procedures Code to ensure that it meets the above requirements for integrity and temperature rise.
5. **Bulkhead deck** is the uppermost deck up to which the transverse watertight bulkheads are carried.



6. **Cargo area** is that part of the ship that contains cargo holds, cargo tanks, slop tanks and cargo pump-rooms including pump-rooms, cofferdams, ballast and void spaces adjacent to cargo tanks and also deck areas throughout the entire length and breadth of the part of the ship over the above-mentioned spaces.
7. **Cargo ship** is any ship which is not a passenger ship.
8. **Cargo spaces** are spaces used for cargo, cargo oil tanks, tanks for other liquid cargo and trunks to such spaces.
9. **Central control station** is a control station in which the following control and indicator functions are centralized:
  - (1) fixed fire detection and fire alarm systems;
  - (2) automatic sprinkler, fire detection and fire alarm systems;
  - (3) fire door indicator panels;
  - (4) fire door closure;
  - (5) watertight door indicator panels;
  - (6) watertight door closures;
  - (7) ventilation fans;
  - (8) general/fire alarms;
  - (9) communication systems including telephones; and **[See Guidance]**
  - (10) microphones to public address systems.
10. **"C" class divisions** are divisions constructed of approved non-combustible materials. They need meet neither requirements relative to the passage of smoke and flame nor limitations relative to the temperature rise. Combustible veneers are permitted provided they meet the requirements of this Part.
11. **Chemical tanker** is a ship specified in **Pt 7, Ch 6** of the Rules of Steel Ship.
12. **Closed ro-ro spaces** are ro-ro spaces which are neither open ro-ro spaces nor weather decks.
13. **Closed vehicle spaces** are vehicle spaces which are neither open vehicle spaces nor weather decks.
14. **Combination carrier** is a cargo ship designed to carry both oil and solid cargoes in bulk.
15. **Combustible material** is any material other than a non-combustible material.
16. **Continuous "B" class ceilings or linings** are those "B" class ceilings or linings which terminate at an "A" or "B" class division.
17. **Continuously manned central control station** is a central control station which is continuously manned by a responsible member of the crew.
18. **Control stations** are those spaces in which the ship's radio or main navigating equipment or the emergency source of power is located or where the fire recording or fire control equipment is centralized. Spaces where the fire recording or fire control equipment is centralized are also considered to be a fire control station. **[See Guidance]**
19. **Crude oil** is any oil occurring naturally in the earth whether or not treated to render it suitable for transportation and includes crude oil where certain distillate fractions may have been removed from or added to.
20. **Dangerous goods** are those goods referred to in the IMDG Code of IMO.
21. **Deadweight** is the difference in tonnes between the displacement of a ship in water of a specific gravity of 1.025 at the load waterline corresponding to the assigned summer freeboard and the lightweight of the ship.
22. **Fire Safety Systems Code**(hereafter referred to as "FSS Code") means the International Code for Fire Safety Systems as adopted by the International Maritime Organization.
23. **Fire Test Procedures Code**(hereafter referred to as "FTP Code") means the International Code for Application of Fire Test Procedures as adopted by the International Maritime Organization.
24. **Flashpoint** is the temperature in degrees Celsius (closed cup test) at which a product will give off enough flammable vapour to be ignited, as determined by an approved flashpoint apparatus.

25. **Gas carrier** is a ship specified in **Pt 7, Ch 5** of the Rules of Steel Ships.
26. **Helideck** is a purpose-built helicopter landing area located on a ship including all structure, fire-fighting appliances and other equipment necessary for the safe operation of helicopters.
27. **Helicopter facility** is a helideck including any refuelling and hangar facilities.
28. **Lightweight** is the displacement of a ship in tonnes without cargo, fuel, lubricating oil, ballast water, fresh water and feedwater in tanks, consumable stores, and passengers and crew and their effects. (2018) **[See Guidance]**
29. **Low flame spread** means that the surface thus described will adequately restrict the spread of flame, this being determined in accordance with the FTP Code.
30. **Machinery spaces** are machinery spaces of category A and other spaces containing propulsion machinery, boilers, oil fuel units, steam and internal combustion engines, generators and major electrical machinery, oil filling stations, refrigerating, stabilizing, ventilation and air conditioning machinery, and similar spaces, and trunks to such spaces.
31. **Machinery spaces of category A** are those spaces and trunks to such spaces which contain either:
  - (1) internal combustion machinery used for main propulsion;
  - (2) internal combustion machinery used for purposes other than main propulsion where such machinery has in the aggregate a total power output of not less than 375 kW; or
  - (3) any oil-fired boiler or oil fuel unit, or any oil-fired equipment other than boilers, such as inert gas generators, incinerators, etc.
32. **Main vertical zones** are those sections into which the hull, superstructure and deckhouses are divided by "A" class divisions, the mean length and width of which on any deck does not in general exceed 40 m.
33. **Non-combustible material** is a material which neither burns nor gives off flammable vapours in sufficient quantity for self-ignition when heated to approximately 750 °C, this being determined in accordance with the FTP Code.
34. **Oil fuel unit** is the equipment used for the preparation of oil fuel for delivery to an oil-fired boiler, or equipment used for the preparation for delivery of heated oil to an internal combustion engine, and includes any oil pressure pumps, filters and heaters dealing with oil at a pressure of more than 0.18 MPa. **[See Guidance]**
35. **Open ro-ro spaces** are those ro-ro spaces that are either open at both ends or have an opening at one end, and are provided with adequate natural ventilation effective over their entire length through permanent openings distributed in the side plating or deckhead or from above, having a total area of at least 10 % of the total area of the space sides.
36. **Open vehicle spaces** are those vehicle spaces either open at both ends, or have an opening at one end and are provided with adequate natural ventilation effective over their entire length through permanent openings distributed in the side plating or deckhead or from above, having a total area of at least 10 % of the total area of the space sides.
37. **Passenger ship** is a ship which carries more than twelve passengers.
38. **Prescriptive requirements** means the construction characteristics, limiting dimensions, or fire safety systems
39. **Public spaces** are those portions of the accommodation which are used for halls, dining rooms, lounges and similar permanently enclosed spaces.
40. **Rooms containing furniture and furnishings of restricted fire risk are those rooms containing furniture and furnishings of restricted fire risk** (whether cabins, public spaces, offices or other types of accommodation) in which:
  - (1) case furniture such as desks, wardrobes, dressing tables, bureaux, dressers, are constructed entirely of approved non-combustible materials, except that a combustible veneer not exceeding 2 mm may be used on the working surface of such articles;
  - (2) free-standing furniture such as chairs, sofas, tables, are constructed with frames of non-combustible materials;
  - (3) draperies, curtains and other suspended textile materials have qualities of resistance to the propagation of flame not inferior to those of wool having a mass of mass 0.8 kg/m<sup>2</sup>, this being

- determined in accordance with the FTP Code;
- (4) floor coverings have low flame spread characteristics;
  - (5) exposed surfaces of bulkheads, linings and ceilings have low flame-spread characteristics;
  - (6) upholstered furniture has qualities of resistance to the ignition and propagation of flame, this being determined in accordance with the FTP Code; and
  - (7) bedding components have qualities of resistance to the ignition and propagation of flame, this being determined in accordance with the FTP Code.
41. **Ro-ro spaces** are spaces not normally subdivided in any way and normally extending to either a substantial length or the entire length of the ship in which motor vehicles with fuel in their tanks for their own propulsion or goods (packaged or in bulk, in or on rail or road cars, vehicles (including road or rail tankers), trailers, containers, pallets, demountable tanks or in or on similar stowage units or other receptacles) can be loaded and unloaded normally in a horizontal direction. **【See Guidance】**
42. **Ro-ro passenger ship** means a passenger ship with ro-ro spaces or special category spaces.
43. **Steel or other equivalent material** means any non-combustible material which, by itself or due to insulation provided, has structural and integrity properties equivalent to steel at the end of the applicable exposure to the standard fire test (e.g. aluminium alloy with appropriate insulation).
44. **Sauna** is a hot room with temperatures normally varying between 80 °C ~ 120 °C where the heat is provided by a hot surface (e.g. by an electrically-heated oven). The hot room may also include the space where the oven is located and adjacent bathrooms.
45. **Service spaces** are those spaces used for galleys, pantries containing cooking appliances, lockers, mail and specie rooms, storerooms, workshops other than those forming part of the machinery spaces, and similar spaces and trunks to such spaces. **【See Guidance】**
46. **Special category spaces** are those enclosed vehicle spaces above and below the bulkhead deck, into and from which vehicles can be driven and to which passengers have access. Special category spaces may be accommodated on more than one deck provided that the total overall clear height for vehicles does not exceed 10 m.
47. **A standard fire test** is a test in which specimens of the relevant bulkheads or decks are exposed in a test furnace to temperatures corresponding approximately to the standard time-temperature curve in accordance with the test method specified in the FTP Code.
48. **Tanker** is a cargo ship constructed or adapted for the carriage in bulk of liquid cargoes of an inflammable nature. (2020)
49. **Vehicle spaces** are cargo spaces intended for carriage of motor vehicles with fuel in their tanks for their own propulsion. **【See Guidance】**
50. **Weather deck** is a deck which is completely exposed to the weather from above and from at least two sides.
51. Safe area in the context of a casualty is, from the perspective of habitability, any area(s) which is not flooded or which is outside the main vertical zone(s) in which a fire has occurred such that it can safely accommodate all persons onboard to protect them from hazards to life or health and provide them with basic services. (2018)
52. **Safety centre** is a control station dedicated to the management of emergency situations. Safety systems' operation, control and/or monitoring are an integral part of the safety centre.
53. **Cabin balcony** is an open deck space which is provided for the exclusive use of the occupants of a single cabin and has direct access from such a cabin.
54. **Fire damper** is a device installed in a ventilation duct, which under normal conditions remains open allowing flow in the duct, and is closed during a fire, preventing the flow in the duct to restrict the passage of fire.
- (1) Automatic fire damper is a fire damper that closes independently in response to exposure to fire products;
  - (2) Manual fire damper is a fire damper that is intended to be opened or closed by the crew by hand at the damper itself; and
  - (3) Remotely operated fire damper is a fire damper that is closed by the crew through a control located at a distance away from the controlled damper.

**55. Smoke damper** is a device installed in a ventilation duct, which under normal conditions remains open allowing flow in the duct, and is closed during a fire, preventing the flow in the duct to restrict the passage of smoke and hot gases. A smoke damper is not expected to contribute to the integrity of a fire rated division penetrated by a ventilation duct.

- (1) Automatic smoke damper is a smoke damper that closes independently in response to exposure to smoke or hot gases;
- (2) Manual smoke damper is a smoke damper intended to be opened or closed by the crew by hand at the damper itself; and
- (3) Remotely operated smoke damper is a smoke damper that is closed by the crew through a control located at a distance away from the controlled damper.

**56. Vehicle carrier** means a cargo ship which only carries cargo in ro-ro spaces or vehicle spaces, and which is designed for the carriage of unoccupied motor vehicles without cargo, as cargo. (2021) **【See Guidance】**

**57. Periodically unattended machinery space** is a machinery space of UMA ship specified in **Pt 9, Ch 3** of the Rules.

**58. Helicopter landing area** is an area on a ship designated for occasional or emergency landing of helicopters but not designed for routine helicopter operations. (2018)

**59. Winching area** is a pick-up area provided for the transfer by helicopter of personnel or stores to or from the ship, while the helicopter hovers above the deck. (2021)

#### **104. Other Operation Requirements. 【See Guidance】**

For fire protection, fire detection and fire extinction, those operation requirements which contain operational readiness and maintenance, onboard training and drills and cargo handling operation shall be in accordance with the **Guidance Annex 8-6** as provided separately. ↓

## CHAPTER 2 PROBABILITY OF IGNITION

### Section 1 Arrangements for Oil Fuel, Lubrication Oil and Other Flammable Oils

#### 101. Limitations in the use of oils as fuel

The following limitations shall apply to the use of oil as fuel.

1. Except as otherwise permitted by this paragraph, no oil fuel with a flashpoint of less than 60 °C shall be used;
2. In emergency generators oil fuel with a flashpoint of not less than 43 °C may be used;
3. The use of oil fuel having a flashpoint of less than 60 °C but not less than 43 °C may be permitted (e.g., for feeding the emergency fire pump's engines and the auxiliary machines which are not located in the machinery spaces of category A subject to the following:
  - (1) fuel oil tanks except those arranged in double bottom compartments shall be located outside of machinery spaces of category A
  - (2) provisions for the measurement of oil temperature are provided on the suction pipe of the oil fuel pump
  - (3) stop valves and/or cocks are provided on the inlet side and outlet side of the oil fuel strainers
  - (4) pipe joints of welded construction or of circular cone type or spherical type union joint are applied as much as possible
4. In cargo ships, to which **Rules for ships using low-flashpoint fuels** is not applicable, the use of oil fuel having a lower flashpoint than otherwise specified in 1, for example crude oil, may be permitted provided that such fuel is not stored in any machinery space and subject to the approval by the Administration of the complete installation; and (2018) **[See Guidance]**
5. In ships, to which **Rules for ships using low-flashpoint fuels** is applicable, the use of oil fuel having a lower flashpoint than otherwise specified in 1 is permitted. (2018)

#### 102. Arrangements for oil fuel

In a ship in which oil fuel is used, the arrangements for the storage, distribution and utilization of the oil fuel shall be such as to ensure the safety of the ship and persons on board and shall at least comply with the following provisions.

##### 1. Arrangements for oil fuel

As far as practicable, parts of the oil fuel system containing heated oil under pressure exceeding 0.18 MPa shall be placed in a concealed position such that defects and leakage can readily be observed. The machinery spaces in way of such parts of the oil fuel system shall be adequately illuminated.

##### 2. Ventilation of machinery spaces

The ventilation of machinery spaces shall be sufficient under normal conditions to prevent accumulation of oil vapour.

##### 3. Oil fuel tanks **[See Guidance]**

- (1) Fuel oil, lubrication oil and other flammable oils shall not be carried in forepeak tanks.
- (2) As far as practicable, oil fuel tanks shall be part of the ships structure and shall be located outside machinery spaces of category A. Where oil fuel tanks, other than double bottom tanks, are necessarily located adjacent to or within machinery spaces of category A, at least one of their vertical sides shall be contiguous to the machinery space boundaries, and shall preferably have a common boundary with the double bottom tanks, and the area of the tank boundary common with the machinery spaces shall be kept to a minimum. Where such tanks are situated within the boundaries of machinery spaces of category A they shall not contain oil fuel having a flashpoint of less than 60 °C. In general, the use of free-standing oil fuel tanks shall be avoided. When such tanks are employed their use shall be prohibited in category A machinery spaces on passenger ships. Where permitted, they shall be placed in an oil-tight spill tray of ample size

having a suitable drain pipe leading to a suitably sized spill oil tank.

- (3) No oil fuel tank shall be situated where spillage or leakage therefrom can constitute a fire or explosion hazard by falling on heated surfaces.
- (4) Oil fuel pipes, which, if damaged, would allow oil to escape from a storage, settling or daily service tank having a capacity of 500 liters and above situated above the double bottom, shall be fitted with a cock or valve directly on the tank capable of being closed from a safe position outside the space concerned in the event of a fire occurring in the space in which such tanks are situated. In the special case of deep tanks situated in any shaft or pipe tunnel or similar space, valves on the tank shall be fitted, but control in the event of fire may be effected by means of an additional valve on the pipe or pipes outside the tunnel or similar space. If such an additional valve is fitted in the machinery space it shall be operated from a position outside this space. The controls for remote operation of the valve for the emergency generator fuel tank shall be in a separate location from the controls for remote operation of other valves for tanks located in machinery spaces.
- (5) Safe and efficient means of ascertaining the amount of oil fuel contained in any oil fuel tank shall be provided.
  - (A) Where sounding pipes are used, they shall not terminate in any space where the risk of ignition of spillage from the sounding pipe might arise. In particular, they shall not terminate in passenger or crew spaces. As a general rule, they shall not terminate in machinery spaces. However, where considers that these latter requirements are impracticable, it may permit termination of sounding pipes in machinery spaces on condition that all of the following requirements are met:
    - (a) an oil-level gauge is provided meeting the requirements of paragraph (B);
    - (b) the sounding pipes terminate in locations remote from ignition hazards unless precautions are taken, such as the fitting of effective screens, to prevent the oil fuel in the case of spillage through the terminations of the sounding pipes from coming into contact with a source of ignition; and
    - (c) the termination of sounding pipes are fitted with self-closing blanking devices and with a small-diameter self-closing control cock located below the blanking device for the purpose of ascertaining before the blanking device is opened that oil fuel is not present. Provisions shall be made so as to ensure that any spillage of oil fuel through the control cock involves no ignition hazard.
  - (B) Other oil-level gauges may be used in place of sounding pipes subject to the following conditions:
    - (a) in passenger ships, such gauges shall not require penetration below the top of the tank and their failure or overfilling of the tanks shall not permit release of fuel; and
    - (b) in cargo ships, the failure of such gauges or overfilling of the tank shall not permit release of fuel into the space. The use of cylindrical gauge glasses is prohibited. It may be permitted to use oil-level gauges with flat glasses and self-closing valves between the gauges and fuel tanks.
  - (C) The means prescribed in paragraph (B) which are acceptable shall be maintained in the proper condition to ensure their continued accurate functioning in service.

#### 4. Oil fuel piping **【See Guidance】**

Provisions shall be made to prevent overpressure in any oil tank or in any part of the oil fuel system, including the filling pipes served by pumps on board. Air and overflow pipes and relief valves shall discharge to a position where there is no risk of fire or explosion from the emergence of oils and vapour and shall not lead into crew spaces, passenger spaces nor into special category spaces, closed ro-ro cargo spaces, machinery spaces or similar spaces.

#### 5. Oil fuel piping **【See Guidance】**

- (1) Oil fuel pipes and their valves and fittings shall be of steel or other approved material, except that restricted use of flexible pipes shall be permissible in positions where they are necessary. Such flexible pipes and end attachments shall be of approved fire-resisting materials of adequate strength and shall be constructed to the satisfaction of the Society. For valves, fitted to oil fuel tanks and which are under static pressure, steel or spheroidal-graphite cast iron may be accepted. However, ordinary cast iron valves may be used in piping systems where the design pressure is lower than 7 bar and the design temperature is below 60 °C. **【See Guidance】**
- (2) External high-pressure fuel delivery lines between the high-pressure fuel pumps and fuel in-

jectors shall be protected with a jacketed piping system capable of containing fuel from a high-pressure line failure. A jacketed pipe incorporates an outer pipe into which the high-pressure fuel pipe is placed, forming a permanent assembly. The jacketed piping system shall include a means for collection of leakages and arrangements and shall be provided with an alarm in case of a fuel line failure. If non-metallic materials are used for shielding purpose, they are to be of approved types. **【See Guidance】**

- (3) Oil fuel lines shall not be located immediately above or near units of high temperature including boilers, steam pipelines, exhaust manifolds, silencers or other equipment required to be insulated by 6. As far as practicable, oil fuel lines shall be arranged far apart from hot surfaces, electrical installations or other sources of ignition and shall be screened or otherwise suitably protected to avoid oil spray or oil leakage onto the sources of ignition. The number of joints in such piping systems shall be kept to a minimum.
- (4) Components of a diesel engine fuel system shall be designed considering the maximum peak pressure which will be experienced in service, including any high pressure pulses which are generated and transmitted back into the fuel supply and spill lines by the action of fuel injection pumps. Connections within the fuel supply and spill lines shall be constructed having regard to their ability to prevent pressurized oil fuel leaks while in service and after maintenance.
- (5) In multi-engine installations which are supplied from the same fuel source, means of isolating the fuel supply and spill piping to individual engines, shall be provided. The means of isolation shall not affect the operation of the other engines and shall be operable from a position not rendered inaccessible by a fire on any of the engines.
- (6) Where it may be permitted to convey oil and combustible liquids through accommodation and service spaces, the pipes conveying oil or combustible liquids shall be of a material approved by the Society having regard to the fire risk.

#### 6. Protection of high temperature surfaces

- (1) Surfaces with temperatures above 220 °C which may be impinged as a result of a fuel system failure shall be properly insulated.
- (2) Precautions shall be taken to prevent any oil that may escape under pressure from any pump, filter or heater from coming into contact with heated surfaces.

### 103. Arrangements for lubricating oil

1. The arrangements for the storage, distribution and utilization of oil used in pressure lubrication systems shall be such as to ensure the safety of the ship and persons on board. The arrangements made in machinery spaces of category A, and whenever practicable in other machinery spaces, shall at least comply with the provisions of 1, 3 (3), 3 (4), 3 (5), 4, 5 (1), 5 (3) and 6 of 102. except that: **【See Guidance】**
  - (1) this does not preclude the use of sight-flow glasses in lubricating systems provided that they are shown by testing to have a suitable degree of fire resistance
  - (2) sounding pipes may be authorized in machinery spaces; however, the requirements of 3 (5) (A) (a) and (c) of 102. need not be applied on condition that the sounding pipes are fitted with appropriate means of closure
2. The provisions of 102. 3 (4) shall also apply to lubricating oil tanks except those having a capacity less than 500 liters, storage tanks on which valves are closed during the normal operation mode of the ship, or where it is determined that an unintended operation of a quick closing valve on the oil lubricating tank would endanger the safe operation of the main propulsion and essential auxiliary machinery. **【See Guidance】**

### 104. Arrangements for other flammable oils **【See Guidance】**

Arrangements for other flammable oils is to comply with the following requirements. The arrangements for the storage, distribution and utilization of other flammable oils employed under pressure in power transmission systems, control and activating systems and heating systems shall be such as to ensure the safety of the ship and persons on board. Suitable oil collecting arrangements for leaks shall be fitted below hydraulic valves and cylinders. In locations where means of ignition are present, such arrangements shall at least comply with the provisions of 1, 3 (3), 3 (4), 3 (5), 4, 5 (1), 5 (3) and 6 of 102. and with the provisions of 4 and 5 (1) of 102. in respect of strength and construction.

### **105. Arrangements for oil fuel in periodically unattended machinery spaces**

In addition to the requirements of 101. to 104., the oil fuel and lubricating oil systems in a periodically unattended machinery space shall comply with the following:

1. where daily service oil fuel tanks are filled automatically, or by remote control, means shall be provided to prevent overflow spillages. Other equipment which treats flammable liquids automatically (e.g. oil fuel purifiers) which, whenever practicable, shall be installed in a special space reserved for purifiers and their heaters, shall have arrangements to prevent overflow spillages; and
2. where daily service oil fuel tanks or settling tanks are fitted with heating arrangements, a high temperature alarm shall be provided if the flashpoint of the oil fuel can be exceeded.

## **Section 2 Arrangements for Gaseous Fuel for Domestic Purpose**

### **201. Arrangements for gaseous fuel for domestic purpose [See Guidance]**

Gaseous fuel systems used for domestic purposes shall be approved by the Society. Storage of gas bottles shall be located on the open deck or in a well ventilated space which opens only to the open deck.

## **Section 3 Miscellaneous Items of Ignition Sources and Ignitability**

### **301. Electric radiators [See Guidance]**

Electric radiators, if used, shall be fixed in position and so constructed as to reduce fire risks to a minimum. No such radiators shall be fitted with an element so exposed that clothing, curtains, or other similar materials can be scorched or set on fire by heat from the element.

### **302. Waste receptacles [See Guidance]**

Waste receptacles shall be constructed of non-combustible materials with no openings in the sides or bottom.

### **303. Insulation surfaces protected against oil penetration [See Guidance]**

In spaces where penetration of oil products is possible, the surface of insulation shall be impervious to oil or oil vapours.

### **304. Primary deck coverings**

Primary deck coverings, if applied within accommodation and service spaces and control stations, or if applied on cabin balconies of passenger ships shall be of approved material which will not readily ignite, this being determined in accordance with the FTP Code.

## **Section 4 Cargo Areas of Tankers [See Guidance]**

### **401. Separation of cargo oil tanks**

1. Cargo pump-rooms, cargo tanks, slop tanks and cofferdams shall be positioned forward of machinery spaces. However, oil fuel bunker tanks need not be forward of machinery spaces. Cargo tanks and slop tanks shall be isolated from machinery spaces by cofferdams, cargo pump-rooms, oil bunker tanks or ballast tanks. Pump-rooms containing pumps and their accessories for ballasting those spaces situated adjacent to cargo tanks and slop tanks and pumps for oil fuel transfer, shall be considered as equivalent to a cargo pump-room within the context of this regulation provided that such pump-rooms have the same safety standard as that required for cargo pump-rooms. Pump-rooms intended solely



for ballast or oil fuel transfer, however, need not comply with the requirements of **Ch 8, Sec 8**. The lower portion of the pump-room may be recessed into machinery spaces of category A to accommodate pumps, provided that the deck head of the recess is in general not more than one third of the moulded depth above the keel, except that in the case of ships of not more than 25,000 tonnes deadweight, where it can be demonstrated that for reasons of access and satisfactory piping arrangements this is impracticable, the Society may permit a recess in excess of such height, but not exceeding one half of the moulded depth above the keel. **[See Guidance]**

2. Main cargo control stations, control stations, accommodation and service spaces(excluding isolated cargo handling gear lockers) shall be positioned aft of cargo tanks, slop tanks, and spaces which isolate cargo or slop tanks from machinery spaces, but not necessarily aft of the oil fuel bunker tanks and ballast tanks, and shall be arranged in such a way that a single failure of a deck or bulkhead shall not permit the entry of gas or fumes from the cargo tanks into an accommodation space, main cargo control stations, control station, or service spaces. A recess provided in accordance with **1** above need not be taken into account when the position of these spaces is being determined. **[See Guidance]**
3. However, where deemed necessary, the Society may permit main cargo control stations, control stations, accommodation and service spaces forward of the cargo tanks, slop tanks and spaces which isolate cargo and slop tanks from machinery spaces, but not necessarily forward of oil fuel bunker tanks or ballast tanks. Machinery spaces, other than those of category A, may be permitted forward of the cargo tanks and slop tanks provided they are isolated from the cargo tanks and slop tanks by cofferdams, cargo pump-rooms, oil fuel bunker tanks or ballast tanks, and have at least one portable fire extinguisher. In cases where they contain internal combustion machinery, one approved foam-type extinguisher of at least 45 liters capacity or equivalent shall be arranged in addition to portable fire extinguishers. If operation of a semi-portable fire extinguisher is impracticable, this fire extinguisher may be replaced by two additional portable fire extinguishers. Accommodation spaces, main cargo control spaces, control stations and service spaces shall be arranged in such a way that a single failure of a deck or bulkhead shall not permit the entry of gas or fumes from the cargo tanks into such spaces. In addition, where deemed necessary for the safety or navigation of the ship, the Society may permit machinery spaces containing internal combustion machinery not being main propulsion machinery having an output greater than 375 kW to be located forward of the cargo area provided the arrangements are in accordance with the provisions of this paragraph. **[See Guidance]**
4. Combination carriers only are to comply with the following requirements.
  - (1) The slop tanks shall be surrounded by cofferdams except where the boundaries of the slop tanks, where slop may be carried on dry cargo voyages, are part of the hull, main cargo deck, cargo pump-room bulkhead or oil fuel bunker tank. These cofferdams shall not be open to a double bottom, pipe tunnel, pump-room or other enclosed space, nor shall they be used for cargo or ballast and shall not be connected to piping systems serving oil cargo or ballast. Means shall be provided for filling the cofferdams with water and for draining them. Where the boundary of a slop tank is part of the cargo pump-room bulkhead, the pump-room shall not be open to the double bottom, pipe tunnel or other enclosed space; however, openings provided with gastight bolted covers may be permitted; **[See Guidance]**
  - (2) Means shall be provided for isolating the piping connecting the pump-room with the slop tanks referred to in (1). The means of isolation shall consist of a valve followed by a spectacle flange or a spool piece with appropriate blank flanges. This arrangement shall be located adjacent to the slop tanks, but where this is unreasonable or impracticable, it may be located within the pump-room directly after the piping penetrates the bulkhead. A separate permanently installed pumping and piping arrangement incorporating a manifold, provided with a shut-off valve and a blank flange, shall be provided for discharging the contents of the slop tanks directly to the open deck for disposal to shore reception facilities when the ship is in the dry cargo mode. When the transfer system is used for slop transfer in the dry cargo mode, it shall have no connection to other systems. Separation from other systems by means of removal of spool pieces may be accepted;
  - (3) Hatches and tank cleaning openings to slop tanks shall only be permitted on the open deck and shall be fitted with closing arrangements. Except where they consist of bolted plates with bolts at watertight spacing, these closing arrangements shall be provided with locking arrangements under the control of the responsible ship's officer; and
  - (4) Where cargo wing tanks are provided, cargo oil lines below deck shall be installed inside these

tanks. However, the Society may permit cargo oil lines to be placed in special ducts provided there are capable of being adequately cleaned and ventilated to the satisfaction of the Society. Where cargo wing tanks are not provided, cargo oil lines below deck shall be placed in special ducts.

5. Where the fitting of a navigation position above the cargo area is shown to be necessary, it shall be for navigation purposes only and it shall be separated from the cargo tank deck by means of an open space with a height of at least 2 m. The fire protection requirements for such a navigation position shall be that required for control stations, as specified in regulation **Ch 7, 104. 2** and other provisions for tankers, as applicable.
6. Means shall be provided to keep deck spills away from the accommodation and service areas. This may be accomplished by provision of a permanent continuous coaming of a height of at least 300 mm, extending from side to side. Special consideration shall be given to the arrangements associated with stern loading. **【See Guidance】**

#### 402. Restriction on boundary openings

1. Except as permitted in **2** access doors, air inlets and openings to accommodation spaces, service spaces, control stations and machinery spaces shall not face the cargo area. They shall be located on the transverse bulkhead not facing the cargo area or on the outboard side of the superstructure or deckhouse at a distance of at least 4% of the length of the ship but not less than 3m from the end of the superstructure or deckhouse facing the cargo area. This distance need not exceed 5m. **【See Guidance】**
2. The Society may permit access doors in boundary bulkheads facing the cargo area or within the 5m limits specified in **1**, to main cargo control stations and to such service spaces used as provision rooms, store-rooms and lockers, provided they do not give access directly or indirectly to any other space containing or providing for accommodation, control stations or service spaces such as galleys, pantries or workshops, or similar spaces containing sources of vapour ignition. The boundary of such a space shall be insulated to "A-60" standard, with the exception of the boundary facing the cargo area. Bolted plates for the removal of machinery may be fitted within the limits specified in **1**. Wheelhouse doors and windows may be located within the limits specified in **1** so long as they are designed to ensure that the wheelhouse can be made rapidly and efficiently gas and vapour tight. **【See Guidance】**
3. Windows and sidescuttles facing the cargo area and on the sides of the superstructures and deckhouses within the limits specified in **1** shall be of the fixed (non-opening) type. Such windows and sidescuttles, except wheelhouse windows, shall be constructed to "A-60" class standard except that "A-0" class standard is acceptable for windows and side scuttles outside the limit specified in **Ch 7, 104. 2 (5)**.
4. Where there is permanent access from a pipe tunnel to the main pump-room, a watertight door shall be fitted complying with the relevant requirements and, in addition, with the following:
  - (1) in addition to the bridge operation, the watertight door shall be capable of being manually closed from outside the main pump-room entrance; and
  - (2) the watertight door shall be kept closed during normal operations of the ship except when access to the pipe tunnel is required. **【See Guidance】**
5. Permanent approved gastight lighting enclosures for illuminating cargo pump-rooms may be permitted in bulkheads and decks separating cargo pump-rooms and other spaces provided they are of adequate strength and the integrity and gastightness of the bulkhead or deck is maintained.
6. The arrangement of ventilation inlets and outlets and other deckhouse and superstructure boundary space openings shall be such as to complement the provisions of **403.** and **Ch 9, Sec 5**. Such vents, especially for machinery spaces, shall be situated as far aft as practicable. Due consideration in this regard shall be given when the ship is equipped to load or discharge at the stern. Sources of ignition such as electrical equipment shall be so arranged as to avoid an explosion hazard.

### 403. Cargo tank venting

#### 1. General requirements

The venting systems of cargo tanks are to be entirely distinct from the air pipes of the other compartments of the ship. The arrangements and position of openings in the cargo tank deck from which emission of flammable vapours can occur shall be such as to minimize the possibility of flammable vapours being admitted to enclosed spaces containing a source of ignition, or collecting in the vicinity of deck machinery and equipment which may constitute an ignition hazard. In accordance with this general principle, the criteria in 2 to 5 and Ch 9, Sec 5 will apply.

#### 2. Venting arrangements

- (1) The venting arrangements in each cargo tank may be independent or combined with other cargo tanks and may be incorporated into the inert gas piping.
- (2) Where the arrangements are combined with other cargo tanks, either stop valves or other acceptable means shall be provided to isolate each cargo tank. Where stop valves are fitted, they shall be provided with locking arrangements which shall be under the control of the responsible ship's officer. There shall be a clear visual indication of the operational status of the valves or other acceptable means. Where tanks have been isolated, it shall be ensured that relevant isolating valves are opened before cargo loading or ballasting or discharging of those tanks is commenced. Any isolation must continue to permit the flow caused by thermal variations in a cargo tank in accordance with Ch 9, 501. 1. **[See Guidance]**
- (3) If cargo loading and ballasting or discharging of a cargo tank or cargo tank group is intended, which is isolated from a common venting system, that cargo tank or cargo tank group shall be fitted with a means for over-pressure or under-pressure protection as required in Ch 9, 503. 2.
- (4) The venting arrangements shall be connected to the top of each cargo tank and shall be self-draining to the cargo tanks under all normal conditions of trim and list of the ship. Where it may not be possible to provide self-draining lines, permanent arrangements shall be provided to drain the vent lines to a cargo tank.

#### 3. Safety devices in venting systems

The venting system shall be provided with devices to prevent the passage of flame into the cargo tanks. The design, testing and locating of these devices shall comply with the requirements established on the basis of **the guidelines** developed by the IMO Organization. Ullage openings shall not be used for pressure equalization. They shall be provided with self-closing and tightly sealing covers. Flame arresters and screens are not permitted in these openings. **[See Guidance]**

#### 4. Vent outlets for cargo handling and ballasting

- (1) Vent outlets for cargo loading, discharging and ballasting required by Ch 9, 501. 2 shall: **[See Guidance]**
  - (A) permit the free flow of vapour mixtures; or permit the throttling of the discharge of the vapour mixtures to achieve a velocity of not less than 30 m/s ;
  - (B) be so arranged that the vapour mixture is discharged vertically upwards;
  - (C) where the method is by free flow of vapour mixtures, be such that the outlet shall be not less than 6 m above the cargo tank deck or fore and aft catwalk if situated within 4 m of the catwalk and located not less than 10 m measured horizontally from the nearest air intakes and openings to enclosed spaces containing a source of ignition and from deck machinery, which may include anchor windlass and chain locker openings, and equipment which may constitute an ignition hazard; and
  - (D) where the method is by high-velocity discharge, be located at a height not less than 2 m above the cargo tank deck and not less than 10 m measured horizontally from the nearest air intakes and openings to enclosed spaces containing a source of ignition and from deck machinery, which may include anchor windlass and chain locker openings, and equipment which may constitute an ignition hazard. These outlets shall be provided with high velocity devices of an approved type.
- (2) The arrangements for the venting of vapours displaced from the cargo tanks during loading and ballasting shall comply with 403. and Ch 9, Sec 5. and shall consist of either one or more mast risers, or a number of high-velocity vents. The inert gas supply main may be used for such venting.

## 5. Isolation of slop tanks in combination carriers

In combination carriers, the arrangements for isolating slop tanks containing oil or oil residues from other cargo tanks shall consist of blank flanges which will remain in position at all times when cargo other than liquid cargoes are carried.

## 404. Ventilation

### 1. Ventilation systems in cargo pump rooms

Cargo pump-rooms shall be mechanically ventilated and discharges from the exhaust fans shall be led to a safe place on the open deck. The ventilation of these rooms shall have sufficient capacity to minimize the possibility of accumulation of flammable vapours. The number of air changes shall be at least 20 per hour, based upon the gross volume of the space. The air ducts shall be arranged so that all of the space is effectively ventilated. The ventilation shall be of the suction type using fans of the non-sparking type. **【See Guidance】**

### 2. Ventilation systems in combination carriers

In combination carriers, cargo spaces and any enclosed spaces adjacent to cargo spaces shall be capable of being mechanically ventilated. The mechanical ventilation may be provided by portable fans. An approved fixed gas warning system capable of monitoring flammable vapours shall be provided in cargo pump-rooms, pipe ducts and cofferdams, as referred to in **401. 4** adjacent to slop tanks. Suitable arrangements shall be made to facilitate measurement of flammable vapours in all other spaces within the cargo area. Such measurements shall be made possible from the open deck or easily accessible positions.

## 405. Inert gas systems **【See Guidance】**

### 1. Application

- (1) For tankers of 8,000 tonnes deadweight and upwards, when carrying cargoes described as the **Ch 1, 101. 4** (1) and (2) of the Rules, the protection of the cargo tanks shall be achieved by a fixed inert gas system in accordance with the requirements of the FSS Code, except that the Society may accept other equivalent systems or arrangements, as described in **3**.
- (2) Tankers operating with a cargo tank cleaning procedure using crude oil washing shall be fitted with an inert gas system complying with the FSS Code and with fixed tank washing machines.
- (3) Tankers required to be fitted with inert gas systems shall comply with the following provisions:
  - (A) double-hull spaces shall be fitted with suitable connections for the supply of inert gas;
  - (B) where hull spaces are connected to a permanently fitted inert gas distribution system, means shall be provided to prevent hydrocarbon gases from the cargo tanks entering the double hull spaces through the system; and
  - (C) where such spaces are not permanently connected to an inert gas distribution system, appropriate means shall be provided to allow connection to the inert gas main.

### 2. General requirements for inert gas systems

- (1) The inert gas system shall be capable of inerting, purging and gas-freeing empty tanks and maintaining the atmosphere in cargo tanks with the required oxygen content.
- (2) Tankers fitted with a fixed inert gas system shall be provided with a closed ullage system.

### 3. Requirements for equivalent systems

- (1) The Society may, after having given consideration to the ship's arrangement and equipment, accept other fixed installations, in accordance with (3) and SOLAS I/5.
- (2) For tankers of 8,000 tonnes deadweight and upwards but less than 20,000 tonnes deadweight, in lieu of fixed installations as required by (1), the Society may accept other equivalent arrangements or means of protection in accordance with (3) and SOLAS I/5.
- (3) Equivalent systems or arrangements shall:
  - (A) be capable of preventing dangerous accumulations of explosive mixtures in intact cargo tanks during normal service throughout the ballast voyage and necessary in-tank operations; and
  - (B) be so designed as to minimize the risk of ignition from the generation of static electricity by the system itself.

#### 406. Inerting, purging and gas freeing

1. Arrangements for purging and/or gas freeing shall be such as to minimize the hazards due to dispersal of flammable vapours in the atmosphere and to flammable mixtures in a cargo tank.
2. The procedure for cargo tank purging and/or gas freeing shall be carried out in accordance with the requirements specified in the Guidance. **[See Guidance]**
3. The arrangements for inerting, purging or gas-freeing of empty tanks as required in **405.2 (1)** shall be to the satisfaction of the Society and shall be such that the accumulation of hydrocarbon vapours in pockets formed by the internal structural members in a tank is minimized and that :
  - (1) on individual cargo tanks, the gas outlet pipe, if fitted, shall be positioned as far as practicable from the inert gas/air inlet and in accordance with paragraph **403.** and **Ch 9, Sec 5.** The inlet of such outlet pipes may be located either at deck level or at not more than 1 m above the bottom of the tank
  - (2) the cross-sectional area of such gas outlet pipe referred to in (1) shall be such that an exit velocity of at least 20 m/s can be maintained when any three tanks are being simultaneously supplied with inert gas. Their outlets shall extend not less than 2 m above deck level
  - (3) each gas outlet referred to in (2) shall be fitted with suitable blanking arrangements.  
**[See Guidance]**

#### 407. Gas measurement and detection

##### 1. Portable instrument

Tankers are to be equipped with at least one portable instrument for measuring oxygen and one portable instrument for flammable vapour concentrations, together with a sufficient set of spares. Suitable means are to be provided for the calibration of such instruments. **[See Guidance]**

##### 2. Arrangements for gas measurement in double-hull spaces and double-bottom spaces

- (1) Suitable portable instruments for measuring oxygen and flammable vapour concentrations shall be provided. In selecting these instruments, due attention shall be given to their use in combination with the fixed gas-sampling-line systems referred to in (2).
- (2) Where the atmosphere in double hull spaces cannot be reliably measured using flexible gas sampling hoses, such spaces shall be fitted with permanent gas sampling lines. The configuration of gas sampling lines shall be adapted to the design of such spaces.
- (3) The materials of construction and the dimensions of gas sampling lines shall be such as to prevent restriction. Where plastic materials are used, they shall be electrically conductive.

##### 3. Arrangements for fixed hydrocarbon gas detection systems in double-hull and double-bottom spaces of oil tankers **[See Guidance]**

- (1) In addition to the requirements in **1** and **2**, oil tankers of 20,000 tonnes deadweight and above are to be provided with a fixed hydrocarbon gas detection system complying with the FSS Code for measuring hydrocarbon gas concentrations in all ballast tanks and void spaces of double-hull and double-bottom spaces adjacent to the cargo tanks, including the forepeak tank and any other tanks and spaces under the bulkhead deck adjacent to cargo tanks.
- (2) Oil tankers provided with constant operative inerting systems for such spaces need not be equipped with fixed hydrocarbon gas detection equipment.
- (3) Notwithstanding the above, cargo pump-rooms subject to the provisions of **410.** need not comply with the requirements of this paragraph.

#### 408. Air supply to double hull and double bottom spaces

Double hull and double bottom spaces shall be fitted with suitable connections for the supply of air.

#### 409. Protection of cargo area

Drip pans for collecting cargo residues in cargo lines and hoses shall be provided in the area of pipe and hose connections under the manifold area. Cargo hoses and tank washing hoses shall have electrical continuity over their entire lengths including couplings and flanges (except shore connections) and should be earthed for removal of electrostatic charges.

#### 410. Protection of cargo pump-rooms in Tanker **【See Guidance】**

1. Cargo pumps, ballast pumps and stripping pumps, installed in cargo pump-rooms and driven by shafts passing through pump-room bulkheads shall be fitted with temperature sensing devices for bulkhead shaft glands, bearings and pump casings. A continuous audible and visual alarm signal shall be automatically effected in the cargo control room or the pump control station.
2. Lighting in cargo pump-rooms, except emergency lighting, shall be interlocked with ventilation such that the ventilation shall be in operation when switching on the lighting. Failure of the ventilation system shall not cause the lighting to go out. **【See Guidance】**
3. A system for continuous monitoring of the concentration of hydrocarbon gases shall be fitted. Sampling points or detector heads shall be located in suitable positions in order that potentially dangerous leakages are readily detected. When the hydrocarbon gas concentration reaches a pre-set level which shall not be higher than 10 % of the lower flammable limit, a continuous audible and visual alarm signal shall be automatically effected in the pump-room, engine control room, cargo control room and navigation bridge to alert personnel to the potential hazard. **【See Guidance】**
4. All pump-rooms shall be provided with bilge level monitoring devices together with appropriately located alarms. ⚓

## CHAPTER 3 FIRE GROWTH POTENTIAL

### Section 1 Control of Air Supply and Flammable Liquid to The Spaces

#### 101. Closing appliances and stopping devices of ventilation

1. The main inlets and outlets of all ventilation systems shall be capable of being closed from outside the spaces being ventilated. The means of closing shall be easily accessible as well as prominently and permanently marked and shall indicate whether the shutoff is open or closed. **【See Guidance】**
2. Power ventilation of accommodation spaces, service spaces, cargo spaces, control stations and machinery spaces shall be capable of being stopped from an easily accessible position outside the space being served. This position shall not be readily cut off in the event of a fire in the spaces served. **【See Guidance】**
3. In passenger ships carrying more than 36 passengers, power ventilation, except machinery space and cargo space ventilation and any alternative system which may be required under **Ch 6, 201.** shall be fitted with controls so grouped that all fans may be stopped from either of two separate positions which shall be situated as far apart as practicable. Fans serving power ventilation systems to cargo spaces shall be capable of being stopped from a safe position outside such spaces.

#### 102. Means of control in machinery spaces

1. Means of control shall be provided for opening and closure of skylights, closure of openings in funnels which normally allow exhaust ventilation and closure of ventilator dampers.
2. Means of control shall be provided for stopping ventilating fans. Controls provided for the power ventilation serving machinery spaces shall be grouped so as to be operable from two positions, one of which shall be outside such spaces. The means provided for stopping the power ventilation of the machinery spaces shall be entirely separate from the means provided for stopping ventilation of other spaces.
3. Means of control shall be provided for stopping forced and induced draught fans, oil fuel transfer pumps, oil fuel unit pumps, lubricating oil service pumps, thermal oil circulating pumps and oil separators (purifiers). However, **4** and **5** need not apply to oily water separators.
4. The controls required in **1** to **3** and in **Ch 2, 102. 3 (4)** shall be located outside the space concerned so they will not be cut off in the event of fire in the space they serve.
5. In passenger ships, the controls required in paragraphs **1** to **4** and in **Ch 6, 201. 3** and **Ch 7, 402. 3** and the controls for any required fire-extinguishing system shall be situated at one control position or grouped in as few positions as possible to the satisfaction of the Society. Such positions shall have a safe access from the open deck.

#### 103. Additional requirements for means of control in periodically unattended machinery spaces **【See Guidance】**

1. For periodically unattended machinery spaces, the Society shall give special consideration to maintaining the fire integrity of the machinery spaces, the location and centralization of the fire-extinguishing system controls, the required shutdown arrangements (e.g. ventilation, fuel pumps, etc.) and that additional fire-extinguishing appliances and other fire-fighting equipment and breathing apparatus may be required.
2. In passenger ships, these requirements shall be at least equivalent to those of machinery spaces normally attended.

## 104. Ventilation fan of non-sparking type [See Guidance]

### 1. Design criteria

- (1) Air gap  
The air gap between the impeller and the casing is not to be less than 0,1 of the shaft diameter in way of the impeller bearing but not less than 2 mm. It need not be more than 13 mm.
- (2) Protection screen  
Protection screens of not more than 13mm square mesh are to be fitted in the opening of ventilation ducts on the open deck to prevent the entrance of objects into the fan housing.

### 2. Materials

- (1) Impeller and housing  
The impeller and the housing in way of the impeller are to be made of alloys which are recognised as being spark proof by appropriate test.
- (2) Electrostatic charges  
Electrostatic charges both in the rotating body and the casing are to be prevented by the use of antistatic materials. Furthermore, the installation on board of the ventilation units is to be such as to ensure the safe bonding to the hull of the units themselves.
- (3) Acceptable Combination of Materials  
Tests may not be required for fans having the following combinations:
  - (A) Impellers and/or housings of nonmetallic material, due regard being paid to the elimination of static electricity
  - (B) Impellers and casings of non-ferrous materials
  - (C) Impellers of aluminium alloys or magnesium alloys and a ferrous (including austenitic stainless steel) housing on which a ring of suitable thickness on non-ferrous materials is fitted in way of the impeller
  - (D) Any combination of ferrous (including austenitic stainless steel) impellers and casings with not less than 13 mm design tip clearance
- (4) Unacceptable Combination of Materials  
The following impellers and housings are considered as sparking and are not permitted:
  - (A) Impellers of an aluminium alloy or magnesium alloy and a ferrous housing, regardless of tip clearance
  - (B) Housing made of an aluminium alloy or a magnesium alloy and a ferrous impeller, regardless of tip clearance
  - (C) Any combination of ferrous impeller and casings with less than 13 mm design tip clearance

## Section 2 Fire Protection Materials [See Guidance]

### 201. Use of non-combustible materials

#### 1. Insulating materials

Insulating materials shall be non-combustible, except in cargo spaces, mail rooms, baggage rooms and refrigerated compartments of service spaces. Vapour barriers and adhesives used in conjunction with insulation, as well as the insulation of pipe fittings for cold service systems, need not be of non-combustible materials, but they shall be kept to the minimum quantity practicable and their exposed surfaces shall have low flame spread characteristics.

#### 2. Ceilings and linings

- (1) In passenger ships, except in cargo spaces, partial bulkheads or decks used to screen or to separate adjacent cabin balconies, all linings, grounds, draught stops and ceilings shall be of non-combustible material except in mail rooms, baggage rooms, saunas or refrigerated compartments of service spaces.
- (2) In cargo ships, all linings, ceilings, draught stops and their associated grounds shall be of non-combustible materials in the following spaces:
  - (A) in accommodation and service spaces and control stations for ships where Method IC is specified as referred to in **Ch 5, 305. 1**; and
  - (B) in corridors and stairway enclosures serving accommodation and service spaces and control



stations for ships where Method IIC and IIIC are specified as referred to in **Ch 5, 305. 1 and 2.**

### 3. Partial bulkheads and decks on passenger ships

- (1) Partial bulkheads or decks used to subdivide a space for utility or artistic treatment shall be of non-combustible materials.
- (2) Linings, ceilings and partial bulkheads or decks used to screen or to separate adjacent cabin balconies shall be of non-combustible materials.

## 202. Use of combustible materials

### 1. General

- (1) In passenger ships, "A", "B" or "C" class divisions in accommodation, services spaces and cabin balconies which are faced with combustible materials, facings, mouldings, decorations and veneers shall comply with the provisions of **2 to 4** and **Ch 4**. However, traditional wooden benches and wooden linings on bulkheads and ceilings are permitted in saunas and such materials need not be subject to the calculations prescribed in **2** and **3**. However, the provisions of **3** need not be applied to cabin balconies.
- (2) In cargo ships, non-combustible bulkheads, ceilings and linings fitted in accommodation and service spaces may be faced with combustible materials, facings, mouldings, decorations and veneers provided such spaces are bounded by non-combustible bulkheads, ceilings and linings in accordance with the provisions of **2 to 4** and **Ch 4**.

### 2. Maximum calorific value of combustible materials

Combustible materials used on the surfaces and linings specified in **1** shall have a calorific value not exceeding  $45 \text{ MJ/m}^2$  of the area for the thickness used. The requirements of this paragraph are not applicable to the surfaces of furniture fixed to linings or bulkheads.

### 3. Total volume of combustible materials

Combustible materials used in accordance with **1** shall comply with the following requirements:

- (1) The total volume of combustible facings, mouldings, decorations and veneers in accommodation and service spaces shall not exceed a volume equivalent to 2.5 mm veneer on the combined area of the walls and ceiling linings. Furniture fixed to linings, bulkheads or decks need not be included in the calculation of the total volume of combustible materials; and
- (2) In the case of ships fitted with an automatic sprinkler system complying with the provisions of the FSS Code, the above volume may include some combustible material used for erection of "C" class divisions.

### 4. Low flame-spread characteristics of exposed surfaces

The following surfaces shall have low flame-spread characteristics in accordance with the FTP Code:

- (1) In passenger ships:
  - (A) exposed surfaces in corridors and stairway enclosures and of bulkhead and ceiling linings in accommodation and service spaces (except saunas) and control stations; and
  - (B) surfaces and grounds in concealed or inaccessible spaces in accommodation and service spaces and control stations.
  - (C) exposed surfaces of cabin balconies, except for natural hard wood decking systems.
- (2) In cargo ships:
  - (A) exposed surfaces in corridors and stairway enclosures and of ceilings in accommodation and service spaces (except saunas) and control stations; and
  - (B) surfaces and grounds in concealed or inaccessible spaces in accommodation and service spaces and control stations.

## 203. Furniture in stairway enclosures of passenger ships

Furniture in stairway enclosures of passenger ships shall be limited to seating. It shall be fixed, limited to six seats on each deck in each stairway enclosure, be of restricted fire risk determined in accordance with the FTP Code, and shall not restrict the passenger escape route. The Society may permit additional seating in the main reception area within a stairway enclosure if it is fixed, non-combustible and does not restrict the passenger escape route. Furniture shall not be permitted in passenger and crew corridors forming escape routes in cabin areas. In addition to the above, lockers of non-combus-

tible material, providing storage for non-hazardous safety equipment required by these regulations, may be permitted. Drinking water dispensers and ice cube machines may be permitted in corridors provided they are fixed and do not restrict the width of the escape routes. This applies as well to decorative flower or plant arrangements, statues or other objects of art such as paintings and tapestries in corridors and stairways.

#### **204. Furniture and furnishings on cabin balconies of passenger ships**

On passenger ships, furniture and furnishings on cabin balconies shall comply with regulations **Ch 1, 103. 40** (1), (2), (3), (6) and (7) unless such balconies are protected by a fixed pressure water-spraying and fixed fire detection and fire alarm systems complying with regulations **Ch 5, 801.** and **Ch 8, 501. 3.**

↓

---

## CHAPTER 4 SMOKE GENERATION POTENTIAL AND TOXICITY

### Section 1 Paints, Varnishes and Other Finishes

#### 101. Paints, varnishes and other finishes [See Guidance]

Paints, varnishes and other finishes used on exposed interior surfaces shall not be capable of producing excessive quantities of smoke and toxic products, this being determined in accordance with the FTP Code.

#### 102. Paints, varnishes and other finishes used on exposed surfaces of passenger ship cabin balconies

Paints, varnishes and other finishes used on exposed surfaces of passenger ship cabin balconies, excluding natural hard wood decking systems, shall not be capable of producing excessive quantities of smoke and toxic products, this being determined in accordance with the FTP Code.

### Section 2 Primary Deck Coverings

#### 201. Primary deck coverings [See Guidance]

Primary deck coverings, if applied within accommodation and service spaces and control stations, shall be of approved material which will not give rise to smoke or toxic or explosive hazards at elevated temperatures, this being determined in accordance with the FTP Code.

#### 202. Primary deck coverings on passenger ship cabin balconies

Primary deck coverings on passenger ship cabin balconies shall not give rise to smoke, toxic or explosive hazards at elevated temperatures, this being determined in accordance with the FTP Code. ⚡

## CHAPTER 5 DETECTION AND ALARM

### Section 1 General

#### 101. General requirements

1. A fixed fire detection and fire alarm system shall be provided in accordance with the FSS Code. **[See Guidance]**
2. A fixed fire detection and fire alarm system and a sample extraction smoke detection system required in this regulation and other regulations in this part shall be of an approved type and comply with the FSS Code. **[See Guidance]**
3. Where a fixed fire detection and fire alarm system is required for the protection of spaces other than those specified in **301**, at least one detector complying with the FSS Code shall be installed in each such space.
4. A fixed fire detection and fire alarm system for passenger ships shall be capable of remotely and individually identifying each detector and manually operated call point.

#### 102. Initial and periodical tests

1. The function of fixed fire detection and fire alarm systems required by the relevant regulations of this chapter shall be tested under varying conditions of ventilation after installation.
2. The function of fixed fire detection and fire alarm systems shall be periodically tested to the satisfaction of the Society by means of equipment producing hot air at the appropriate temperature, or smoke or aerosol particles having the appropriate range of density or particle size, or other phenomena associated with incipient fires to which the detector is designed to respond.

### Section 2 Protection of Machinery Spaces

#### 201. Installation

A fixed fire detection and fire alarm system shall be installed in:

1. periodically unattended machinery spaces; **[See Guidance]**
2. machinery spaces where:
  - (1) machinery spaces where the installation of automatic and remote control systems and equipment has been approved in lieu of continuous manning of the space; and
  - (2) machinery spaces where the main propulsion and associated machinery including sources of main source of electrical power are provided with various degrees of automatic or remote control and are under continuous manned supervision from a control room. and
3. enclosed separate spaces containing incinerators

#### 202. Design **[See Guidance]**

The fixed fire detection and fire alarm system required in **201. 1** shall be so designed and the detectors so positioned as to detect rapidly the onset of fire in any part of those spaces and under any normal conditions of operation of the machinery and variations of ventilation as required by the possible range of ambient temperatures. Except in spaces of restricted height and where their use is specially appropriate, detection systems using only thermal detectors shall not be permitted. The detection system shall initiate audible and visual alarms distinct in both respects from the alarms of any other system not indicating fire, in sufficient places to ensure that the alarms are heard and observed on the navigating bridge and by a responsible engineer officer. When the navigating bridge is unmanned the alarm shall sound in a place where a responsible member of the crew is on duty.

## Section 3 Protection of Accommodation and Service Spaces and Control Stations

### 301. Smoke detectors in accommodation spaces

Smoke detectors shall be installed in all stairways, corridors and escape routes within accommodation spaces as provided in **302.**, **303.** and **304.**. Consideration shall be given to the installation of special purpose smoke detectors within ventilation ducting.

### 302. Requirements for passenger ships carrying more than 36 passengers

A fixed fire detection and fire alarm system shall be installed and arranged as to provide smoke detection in service spaces, control stations and accommodation spaces, including corridors, stairways and escape routes within accommodation spaces. Smoke detectors need not be fitted in private bathrooms and galleys. Spaces having little or no fire risk such as voids, public toilets, carbon dioxide rooms and similar spaces need not be fitted with a fixed fire detection and alarm system. Detectors fitted in cabins, when activated, shall also be capable of emitting, or cause to be emitted, an audible alarm within the space where they are located.

### 303. Requirements for passenger ships carrying not more than 36 passengers

There shall be installed throughout each separate zone, whether vertical or horizontal, in all accommodation and service spaces and, where it is considered necessary, in control stations, except spaces which afford no substantial fire risk such as void spaces, sanitary spaces, etc., either:

1. a fixed fire detection and fire alarm system so installed and arranged as to detect the presence of fire in such spaces and providing smoke detection in corridors, stairways and escape routes within accommodation spaces. Detectors fitted in cabins, when activated, shall also be capable of emitting, or cause to be emitted, an audible alarm within the space where they are located.; or
2. an automatic sprinkler, fire detection and fire alarm system of an approved type complying with the relevant requirements of the FSS Code and so installed and arranged as to protect such spaces and, in addition, a fixed fire detection and fire alarm system and so installed and arranged as to provide smoke detection in corridors, stairways and escape routes within accommodation spaces. **[See Guidance]**

### 304. Protection of atriums in passenger ships

In passenger ships, the entire main vertical zone containing the atrium shall be protected throughout with a smoke detection system.

### 305. Cargo ships

For Cargo ships, accommodation and service spaces and control stations of cargo ships shall be protected by a fixed fire detection and fire alarm system and/or an automatic sprinkler, fire detection and fire alarm system as follows depending on a protection method adopted in accordance with **Ch 7 103. 1 (1).** **[See Guidance]**

#### 1. Method IC

A fixed fire detection and fire alarm system shall be so installed and arranged as to provide smoke detection in all corridors, stairways and escape routes within accommodation spaces.

#### 2. Method IIC

An automatic sprinkler, fire detection and fire alarm system of an approved type complying with the relevant requirements of the FSS Code shall be so installed and arranged as to protect accommodation spaces, galleys and other service spaces, except spaces which afford no substantial fire risk such as void spaces, sanitary spaces, etc. In addition, a fixed fire detection and fire alarm system shall be so installed and arranged as to provide smoke detection in all corridors, stairways and escape routes within accommodation spaces.

### 3. Method IIIC

A fixed fire detection and fire alarm system shall be so installed and arranged as to detect the presence of fire in all accommodation spaces and service spaces except spaces which afford no substantial fire risk such as void spaces, sanitary spaces, etc. In addition, a fixed fire detection and fire alarm system shall be so installed and arranged as to provide smoke detection in all corridors, stairways and escape routes within accommodation spaces.

## Section 4 Protection of Cargo Spaces in Passenger Ships

### 401. Protection of cargo spaces in passenger ships

A fixed fire detection and fire alarm system or a sample extraction smoke detection system shall be provided in any cargo space which, in the opinion of the Society, is not accessible, except where it is shown to the satisfaction that the ship is engaged on voyages of such short duration that it would be unreasonable to apply this requirement.

## Section 5 Manually Operated Call Points

### 501. Manually operated call points **【See Guidance】**

Manually operated call points complying with the FSS Code shall be installed throughout the accommodation spaces, service spaces and control stations. One manually operated call point shall be located at each exit into the outside. Manually operated call points shall be readily accessible in the corridors of each deck such that no part of the corridor is more than 20 m from a manually operated call point.

## Section 6 Fire Patrols in Passenger Ships

### 601. Fire patrols

For ships carrying more than 36 passengers an efficient patrol system shall be maintained so that an outbreak of fire may be promptly detected. Each member of the fire patrol shall be trained to be familiar with the arrangements of the ship as well as the location and operation of any equipment he may be called upon to use.

### 602. Inspection hatches

The construction of ceiling and bulkheads shall be such that it will be possible, without impairing the efficiency of the fire protection, for the fire patrols to detect any smoke originating in concealed and inaccessible places, except where in the opinion of the Society there is no risk of fire originating in such places.

### 603. Two-way portable radiotelephone apparatus

Each member of the fire patrol shall be provided with a two-way portable radiotelephone apparatus.

## Section 7 Fire Alarm Signalling Systems in Passenger Ships

### 701. Fire alarm signalling systems in passenger ships

1. Passenger ships shall at all times when at sea, or in port(except when out of service), be so manned or equipped as to ensure that any initial fire alarm is immediately received by a responsible member of the crew.
2. The control panel of fixed fire detection and fire alarm systems shall be designed on the fail-safe principle(e.g. an open detector circuit shall cause an alarm condition).
3. Passenger ships carrying more than 36 passengers shall have the fire detection alarms for the systems required by **302**. centralized in a continuously manned central control station. In addition, controls for remote closing of the fire doors and shutting down the ventilation fans shall be centralized in the same location. The ventilation fans shall be capable of reactivation by the crew at the continuously manned control station. The control panels in the central control station shall be capable of indicating open or closed positions of fire doors and closed or off status of the detectors, alarms and fans. The control panel shall be continuously powered and shall have an automatic change-over to standby power supply in case of loss of normal power supply. The control panel shall be powered from the main source of electrical power and the emergency source of electrical power unless other arrangements are permitted by the regulations, as applicable.
4. A special alarm, operated from the navigation bridge or fire control station, shall be fitted to summon the crew. This alarm may be part of the ship's general alarm system and shall be capable of being sounded independently of the alarm to the passenger spaces.

## Section 8 Protection of cabin balconies on passenger ships

### 801. Protection of cabin balconies on passenger ships [See Guidance]

A fixed fire detection and fire alarm system complying with the provisions of the FSS Code shall be insulated on cabin balconies of ships to which regulation **Ch 2, 202. 4** applies, when furniture and furnishings on such balconies are not as defined in regulations **Ch 1, 103. 40** (1), (2), (3), (6) and (7). ⚡

## CHAPTER 6 CONTROL OF SMOKE SPEED

### Section 1 Protection of Control Stations Outside Machinery Space

#### 101. Protection of control stations outside machinery space [See Guidance]

Practicable measures shall be taken for control stations outside machinery spaces in order to ensure that ventilation, visibility and freedom from smoke are maintained so that, in the event of fire, the machinery and equipment contained therein may be supervised and continue to function effectively. Alternative and separate means of air supply shall be provided and air inlets of the two sources of supply shall be so disposed that the risk of both inlets drawing in smoke simultaneously is minimized. At the discretion of the Society, such requirements need not apply to control stations situated on, and opening on to, an open deck or where local closing arrangements would be equally effective. The ventilation system serving safety centres may be derived from the ventilation system serving the navigation bridge, unless located in an adjacent main vertical zone.

### Section 2 Release of Smoke from Machinery Spaces

#### 201. Release of smoke from machinery spaces

1. The provisions of this paragraph shall apply to machinery spaces of category A and, where the Society considers desirable, to other machinery spaces.
2. Suitable arrangements shall be made to permit the release of smoke, in the event of fire, from the space to be protected, subject to the provisions of **Ch 7, 402. 1**. The normal ventilation systems may be acceptable for this purpose.
3. Means of control shall be provided for permitting the release of smoke and such controls shall be located outside the space concerned so that, in the event of fire, they will not be cut off from the space they serve.
4. In passenger ships, the controls required by **Par 3** shall be situated at one control position or grouped in as few positions as possible to the satisfaction of the Society. Such positions shall have a safe access from the open deck.

### Section 3 Draft Stops

#### 301. Draft stops [See Guidance]

Air spaces enclosed behind ceilings, panelling or linings shall be divided by close-fitting draught stops spaced not more than 14 m apart. In the vertical direction, such enclosed air spaces, including those behind linings of stairways, trunks, etc., shall be closed at each deck.

### Section 4 Smoke Extraction Systems in Atriums of Passenger Ships

#### 401. Smoke extraction systems in atriums of passenger ships

Atriums shall be equipped with a smoke extraction system. The smoke extraction system shall be activated by the required smoke detection system and be capable of manual control. The fans shall be sized such that the entire volume within space can be exhausted in 10 min or less. ⚓



## CHAPTER 7 CONTAINMENT OF FIRE

### Section 1 Thermal and Structural Boundaries

#### 101. Thermal and structural boundaries **[See Guidance]**

Ships of all types shall be subdivided into spaces by thermal and structural divisions having regard to the fire risks of the space.

#### 102. Passenger ships

##### 1. Main vertical zones and horizontal zones

###### (1) The hull, superstructure and deckhouses

(A) In ships carrying more than 36 passengers, the hull, superstructure and deckhouses shall be subdivided into main vertical zones by "A-60" class divisions. Steps and recesses shall be kept to a minimum, but where they are necessary they shall also be "A-60" class divisions. Where a category ⑤, ⑨, ⑩ defined in 3(2)(B) is on one side or where fuel oil tanks are on both sides of the division the standard may be reduced to "A-0".

(B) In ships carrying not more than 36 passengers, the hull, superstructure and deckhouses in way of accommodation and service spaces shall be subdivided into main vertical zones by "A" class divisions. These divisions shall have insulation values in accordance with tables in 4.

(2) As far as practicable, the bulkheads forming the boundaries of the main vertical zones above the bulkhead deck shall be in line with watertight subdivision bulkheads situated immediately below the bulkhead deck. The length and width of main vertical zones may be extended to a maximum of 48 m in order to bring the ends of main vertical zones to coincide with watertight subdivision bulkheads or in order to accommodate a large public space extending for the whole length of the main vertical zone provided that the total area of the main vertical zone is not greater than 1,600 m<sup>2</sup> on any deck. The length or width of a main vertical zone is the maximum distance between the furthestmost points of the bulkheads bounding it. **[See Guidance]**

(3) Such bulkheads shall extend from deck to deck and to the shell or other boundaries.

(4) Where a main vertical zone is subdivided by horizontal "A" class divisions into horizontal zones for the purpose of providing an appropriate barrier between a zone with sprinklers and a zone without sprinklers, the divisions shall extend between adjacent main vertical zone bulkheads and to the shell or exterior boundaries of the ship and shall be insulated in accordance with the fire insulation and integrity values given in **Table 8.7.4**.

(5) On ships designed for special purposes

(A) On ships designed for special purposes, such as automobile or railroad car ferries, where the provision of main vertical zone bulkheads would defeat the purpose for which the ship is intended, equivalent means for controlling and limiting a fire shall be substituted and specifically approved by the Society. Service spaces and ship stores shall not be located on ro-ro decks unless protected in accordance with the applicable regulations.

(B) However, in a ship with special category spaces, such spaces shall comply with the applicable provisions of **Ch 13** and where such compliance would be inconsistent with other requirements for passenger ships specified in this chapter, the requirements of **Ch 13** shall prevail.

##### 2. Bulkheads within a main vertical zone

(1) For ships carrying more than 36 passengers, bulkheads which are not required to be "A" class divisions shall be at least "B" class or "C" class divisions as prescribed in the tables in 3.

(2) For ships carrying not more than 36 passengers, bulkheads within accommodation and service spaces which are not required to be "A" class divisions shall be at least "B" class or "C" class divisions as prescribed in the tables in 4. In addition, corridor bulkheads, where not required to be "A" class, shall be "B" class divisions which shall extend from deck to deck except:

(A) when continuous "B" class ceilings or linings are fitted on both sides of the bulkhead, the portion of the bulkhead behind the continuous ceiling or lining shall be of material which, in thickness and composition, is acceptable in the construction of "B" class divisions, but which shall be required to meet "B" class integrity standards only in so far as is reasonable and practicable in the opinion of the Society; and **[See Guidance]**

- (B) in the case of a ship protected by an automatic sprinkler system complying with the provisions of the FSS Code, the corridor bulkheads may terminate at a ceiling in the corridor provided such bulkheads and ceilings are of "B" class standard in compliance with 4. All doors and frames in such bulkheads shall be of non-combustible materials and shall have the same fire integrity as the bulkhead in which they are fitted.
- (3) Bulkheads required to be "B" class divisions, except corridor bulkheads as prescribed in (2), shall extend from deck to deck and to the shell or other boundaries. However, where a continuous "B" class ceiling or lining is fitted on both sides of a bulkhead which is at least of the same fire resistance as the adjoining bulkhead, the bulkhead may terminate at the continuous ceiling or lining. **【See Guidance】**
3. Fire integrity of bulkheads and decks in ships carrying more than 36 passengers
- (1) In addition to complying with the specific provisions for fire integrity of bulkheads and decks of passenger ships, the minimum fire integrity of all bulkheads and decks shall be as prescribed in **Tables 8.7.1** and **8.7.2**. Where, due to any particular structural arrangements in the ship, difficulty is experienced in determining from the tables the minimum fire integrity value of any divisions, such values shall be determined to the satisfaction of the Society. **【See Guidance】**
- (2) The following requirements shall govern application of the tables:
- (A) **Table 8.7.1** shall apply to bulkheads not bounding either main vertical zones or horizontal zones. **Table 8.7.2** shall apply to decks not forming steps in main vertical zones nor bounding horizontal zones.
- (B) For determining the appropriate fire integrity standards to be applied to boundaries between adjacent spaces, such spaces are classified according to their fire risk as shown in categories ① to ⑭ below. Where the contents and use of a space are such that there is a doubt as to its classification for the purpose of this regulation, or where it is possible to assign two or more classifications to a space, it shall be treated as a space within the relevant category having the most stringent boundary requirements. Smaller, enclosed rooms within a space that have less than 30 % communicating openings to that space are considered separate spaces. The fire integrity of the boundary bulkheads and decks of such smaller rooms shall be as prescribed in **Tables 8.7.1** and **8.7.2**. The title of each category is intended to be typical rather than restrictive. The number in parentheses preceding each category refers to the applicable column or row in the tables.
- ① Control stations  
Spaces containing emergency sources of power and lighting/  
Wheelhouse and chartroom/  
Spaces containing the ship's radio equipment/  
Fire control stations/  
Control room for propulsion machinery when located outside the propulsion machinery space/  
Spaces containing centralized fire alarm equipment/  
Spaces containing centralized emergency public address system stations and equipment
- ② Stairways  
Interior stairways, lifts, totally enclosed emergency escape trunks, and escalators (other than those wholly contained within the machinery spaces) for passengers and crew and enclosures thereto/  
In this connection a stairway which is enclosed at only one level shall be regarded as part of the space from which it is not separated by a fire door.
- ③ Corridors  
Passenger and crew corridors and lobbies
- ④ Evacuation stations and external escape routes  
Survival craft stowage area/  
Open deck spaces and enclosed promenades forming lifeboat and liferaft embarkation and lowering stations/  
Assembly stations, internal and external/  
External stairs and open decks used for escape routes/  
The ship's side to the waterline in the lightest seagoing condition, superstructure and deckhouse sides situated below and adjacent to the liferaft and evacuation slide embarkation areas
- ⑤ Open deck spaces  
Open deck spaces and enclosed promenades clear of lifeboat and liferaft embarkation

and lowering stations/

To be considered in this category, enclosed promenades shall have no significant fire risk, meaning that furnishings shall be restricted to deck furniture. In addition, such spaces shall be naturally ventilated by permanent openings./

Air spaces(the space outside superstructures and deckhouses).

- ⑥ Accommodation spaces of minor fire risk
  - Cabins containing furniture and furnishings of restricted fire risk/
  - Offices and dispensaries containing furniture and furnishings of restricted fire risk/
  - Public spaces containing furniture and furnishings of restricted fire risk and having a deck area of less than 50 m<sup>2</sup>.
- ⑦ Accommodation spaces of moderate fire risk
  - Spaces as in category ⑥ above but containing furniture and furnishings of other than restricted fire risk/
  - Public spaces containing furniture and furnishings of restricted fire risk and having a deck area of 50 m<sup>2</sup> or more/
  - Isolated lockers and small store-rooms in accommodation spaces having areas less than 4 m<sup>2</sup>(in which flammable liquids are not stowed)/
  - Motion picture projection and film stowage rooms. Diet kitchens(containing no open flame)/
  - Cleaning gear lockers(in which flammable liquids are not stowed)/
  - Laboratories (in which flammable liquids are not stowed)/
  - Pharmacies/
  - Small drying rooms(having a deck area of 4 m<sup>2</sup> or less)/
  - Specie rooms/
  - Operating rooms
- ⑧ Accommodation spaces of greater fire risk
  - Public spaces containing furniture and furnishings of other than restricted fire risk and having a deck area of 50 m<sup>2</sup> or more.
  - Barber shops and beauty parlours. Saunas.
  - Sale shops.
- ⑨ Sanitary and similar spaces
  - Communal sanitary facilities, showers, baths, water closets, etc./
  - Small laundry rooms/
  - Indoor swimming pool area/
  - Isolated pantries containing no cooking appliances in accommodation spaces/
  - Private sanitary facilities shall be considered a portion of the space in which they are located/
- ⑩ Tanks, voids and auxiliary machinery spaces having little or no fire risk
  - Water tanks forming part of the ship's structure/
  - Voids and cofferdams/
  - Auxiliary machinery spaces which do not contain machinery having a pressure lubrication system and where storage of combustibles is prohibited, such as:
    - ventilation and air-conditioning rooms;
    - windlass room; steering gear room;
    - stabilizer equipment room;
    - electrical propulsion motor room;
    - rooms containing section switchboards and purely electrical equipment other than oil-filled electrical transformers(above 10 kVA) ;
    - shaft alleys and pipe tunnels;
    - spaces for pumps and refrigeration machinery (not handling or using flammable liquids)/
  - Closed trunks serving the spaces listed above/
  - Other closed trunks such as pipe and cable trunks/
- ⑪ Auxiliary machinery spaces, cargo spaces, cargo and other oil tanks and other similar spaces of moderate fire risk
  - Cargo oil tanks/
  - Cargo holds, trunkways and hatchways/
  - Refrigerated chambers/
  - Oil fuel tanks (where installed in a separate space with no machinery)/

- Shaft alleys and pipe tunnels allowing storage of combustibles/  
Auxiliary machinery spaces as in category ⑩ which contain machinery having a pressure lubrication system or where storage of combustibles is permitted/  
Oil fuel filling stations/  
Spaces containing oil-filled electrical transformers(above 10 kVA)/  
Spaces containing turbine and reciprocating steam engine driven auxiliary generators and small internal combustion engines of power output up to 110 kW driving generators, sprinkler, drencher or fire pumps, bilge pumps, etc./  
Closed trunks serving the spaces listed above/
  - ⑫ Machinery spaces and main galleys  
Main propulsion machinery rooms (other than electric propulsion motor rooms) and boiler rooms/  
Auxiliary machinery spaces other than those in categories ⑩ and ⑪ which contain internal combustion machinery or other oil-burning, heating or pumping units/  
Main galleys and annexes/  
Trunks and casings to the spaces listed above
  - ⑬ Store-rooms, workshops, pantries, etc.  
Main pantries not annexed to galleys/  
Main laundry/  
Large drying rooms (having a deck area of more than 4 m<sup>2</sup>)/  
Miscellaneous stores/  
Mail and baggage rooms/  
Garbage rooms/  
Workshops (not part of machinery spaces, galleys, etc.)/  
Lockers and store-rooms having areas greater than 4 m<sup>2</sup>, other than those spaces that have provisions for the storage of flammable liquids/
  - ⑭ Other spaces in which flammable liquids are stowed  
Paint lockers/  
Store-rooms containing flammable liquids (including dyes, medicines, etc.)/  
Laboratories (in which flammable liquids are stowed)
- (C) Where a single value is shown for the fire integrity of a boundary between two spaces, that value shall apply in all cases;
- (D) Notwithstanding the provisions of 2 there are no special requirements for material or integrity of boundaries where only a dash appears in the tables; and
- (3) Continuous "B" class ceilings or linings, in association with the relevant decks or bulkheads, may be accepted as contributing wholly or in part, to the required insulation and integrity of a division.
- (4) Construction and arrangement of saunas
- (A) The perimeter of the sauna shall be of "A" class boundaries and may include changing rooms, showers and toilets. The sauna shall be insulated to A-60 standard against other spaces except those inside of the perimeter and spaces of categories ⑤, ⑨ and ⑩.
  - (B) Bathrooms with direct access to saunas may be considered as part of them. In such cases, the door between sauna and the bathroom need not comply with fire safety requirements.
  - (C) The traditional wooden lining on the bulkheads and ceiling are permitted in the sauna. The ceiling above the oven shall be lined with a non-combustible plate with an air gap of at least 30 mm. The distance from the hot surfaces to combustible materials shall be at least 500 mm or the combustible materials shall be protected(e.g. non-combustible plate with an air gap of at least 30 mm).
  - (D) The traditional wooden benches are permitted to be used in the sauna.
  - (E) The sauna door shall open outwards by pushing.
  - (F) Electrically heated ovens shall be provided with a timer.

Table 8.7.1 Bulkheads not bounding either main vertical zones or horizontal zones (more than 36 passengers)

Spaces	①	②	③	④	⑤	⑥	⑦	⑧	⑨	⑩	⑪	⑫	⑬	⑭	
Control stations	①	B-0a	A-0	A-0	A-0	A-0	A-60	A-60	A-60	A-0	A-0	A-60	A-60	A-60	A-60
Stairways	②		A-0a	A-0	A-0	A-0	A-0	A-15	A-15	A-0c	A-0	A-15	A-30	A-15	A-30
Corridors	③			B-15	A-60	A-0	B-15	B-15	B-15	B-15	A-0	A-15	A-30	A-0	A-30
Evacuation stations and external escape routes	④				A-0	A-60b,d	A-60b,d	A-60b,d	A-0d/-	A-0	A-0b	A-60b	A-0b	A-0b	A-0b
Open deck spaces	⑤					A-0	A-0	A-0	A-0	A-0	A-0	A-0	A-0	A-0	A-0
Accommodation spaces of minor fire risk	⑥					B-0	B-0	B-0	C	A-0	A-0	A-30	A-0	A-30	A-0
Accommodation spaces of moderate fire risk.	⑦						B-0	B-0	C	A-0	A-15	A-60	A-15	A-60	A-0
Accommodation spaces of greater fire risk.	⑧							B-0	C	A-0	A-30	A-60	A-15	A-60	A-0
Sanitary and similar spaces	⑨								C	A-0	A-0	A-0	A-0	A-0	A-0
Tanks, voids and auxiliary machinery spaces having little no fire risk	⑩									A-0a	A-0	A-0	A-0	A-0	A-0
Auxiliary machinery spaces, cargo spaces, cargo and other oil tanks and other similar spaces of moderate fire risk	⑪										A-0a/-	A-0	A-0	A-0	A-15
Machinery spaces and main galleys	⑫											A-0a	A-0	A-60	A-0
Store-rooms, workshops, pantries, etc.	⑬												A-0a	A-0	A-0
Other spaces in which flammable liquids are stowed	⑭														A-30

Table 8.7.2 Decks not forming steps in main vertical zones nor bounding horizontal zones (more than 36 passengers)

Spaces	①	②	③	④	⑤	⑥	⑦	⑧	⑨	⑩	⑪	⑫	⑬	⑭	
Control stations	①	A-30	A-30	A-15	A-0	A-0	A-0	A-15	A-30	A-0	A-0	A-0	A-60	A-0	A-60
Stairways	②	A-0	A-0	A-0	A-0	A-0	A-0	A-0	A-0	A-0	A-0	A-0	A-30	A-0	A-30
Corridors	③	A-15	A-0	A-0a	A-60	A-0	A-0	A-15	A-15	A-0	A-0	A-0	A-30	A-0	A-30
Evacuation stations and external escape routes	④	A-0	A-0	A-0	A-0	-	A-0	A-0	A-0	A-0	A-0	A-0	A-0	A-0	A-0
Open deck spaces	⑤	A-0	A-0	A-0	A-0	-	A-0	A-0	A-0	A-0	A-0	A-0	A-0	A-0	A-0
Accommodation spaces of minor fire risk	⑥	A-60	A-15	A-0	A-60	A-0	A-0	A-0	A-0	A-0	A-0	A-0	A-0	A-0	A-0
Accommodation spaces of moderate fire risk.	⑦	A-60	A-15	A-15	A-60	A-0	A-0	A-15	A-15	A-0	A-0	A-0	A-0	A-0	A-0
Accommodation spaces of greater fire risk.	⑧	A-60	A-15	A-15	A-60	A-0	A-15	A-15	A-30	A-0	A-0	A-0	A-0	A-0	A-0
Sanitary and similar spaces	⑨	A-0	A-0	A-0	A-0	A-0	A-0	A-0	A-0	A-0	A-0	A-0	A-0	A-0	A-0
Tanks, voids and auxiliary machinery spaces having little no fire risk	⑩	A-0	A-0	A-0	A-0	A-0	A-0	A-0	A-0	A-0	A-0a	A-0	A-0	A-0	A-0
Auxiliary machinery spaces, cargo spaces, cargo and other oil tanks and other similar spaces of moderate fire risk	⑪	A-60	A-60	A-60	A-60	A-0	A-0	A-15	A-30	A-0	A-0	A-0a	A-0	A-0	A-30
Machinery spaces and main galleys	⑫	A-60	A-60	A-60	A-60	A-0	A-60	A-60	A-60	A-0	A-0	A-30	A-30a	A-0	A-60
Store-rooms, workshops, pantries, etc.	⑬	A-60	A-30	A-15	A-60	A-0	A-15	A-30	A-30	A-0	A-0	A-0	A-0	A-0	A-0
Other spaces in which flammable liquids are stowed	⑭	A-60	A-60	A-60	A-60	A-0	A-30	A-60	A-60	A-0	A-0	A-0	A-0	A-0	A-0

Note: To be applied to **Tables 8.7.1** and **8.7.2**

- a Where adjacent spaces are in the same numerical category and superscript "a" appears, a bulkhead or deck between such spaces need not be fitted if deemed unnecessary by the Society. For example, in category ⑫ a bulkhead need not be required between a galley and its annexed pantries provided the pantry bulkhead and decks maintain the integrity of the galley boundaries. A bulkhead is, however, required between a galley and machinery space even though both spaces are in category ⑫.
- b The ship's side, to the waterline in the lightest seagoing condition, superstructure and deckhouse sides situated below and adjacent to liferafts and evacuation slides may be reduced to "A-30".
- c Where public toilets are installed completely within the stairway enclosure, the public toilet bulkhead within the stairway enclosure can be of "B" class integrity.
- d Where spaces of categories ⑥, ⑦, ⑧ and ⑨ are located completely within the outer perimeter of the assembly station, the bulkheads of these spaces are allowed to be of "B-0" class integrity. Control positions for audio, video and light installations may be considered as part of the assembly station.

#### 4. Fire integrity of bulkheads and decks in ships carrying not more than 36 passengers

- (1) In addition to complying with the specific provisions for fire integrity of bulkheads and decks of passenger ships, the minimum fire integrity of bulkheads and decks shall be as prescribed in **Tables 8.7.3** and **8.7.4**.
- (2) The following requirements govern application of the tables:
  - (A) **Tables 8.7.3** and **8.7.4** shall apply respectively to the bulkheads and decks separating adjacent spaces.
  - (B) For determining the appropriate fire integrity standards to be applied to divisions between adjacent spaces, such spaces are classified according to their fire risk as shown in categories ① to ⑩ below. Where the contents and use of a space are such that there is a doubt as to its classification for the purpose of this regulation, or where it is possible to assign two or more classifications to a space, it shall be treated as a space within the relevant category having the most stringent boundary requirements. Smaller, enclosed rooms within a space that have less than 30% communicating openings to that space are considered separate spaces. The fire integrity of the boundary bulkheads and decks of such smaller rooms shall be as prescribed in **Tables 8.7.3** and **8.7.4**. The title of each category is intended to be typical rather than restrictive. The number in parentheses preceding each category refers to the applicable column or row in the tables.
    - ① Control stations
      - Spaces containing emergency sources of power and lighting/  
Wheelhouse and chartroom/  
Spaces containing the ship's radio equipment/  
Fire control stations/  
Control room for propulsion machinery when located outside the machinery space/  
Spaces containing centralized fire alarm equipment/
    - ② Corridors
      - Passenger and crew corridors and lobbies
    - ③ Accommodation spaces
      - Spaces as defined in **Ch 1, 103. 1** excluding corridors
    - ④ Stairways
      - Interior stairways, lifts, totally enclosed emergency escape trunks, and escalators (other than those wholly contained within the machinery spaces) and enclosures thereto/  
In this connection, a stairway which is enclosed only at one level shall be regarded as part of the space from which it is not separated by a fire door/
    - ⑤ Service spaces(low risk)
      - Lockers and store-rooms not having provisions for the storage of flammable liquids and having areas less than 4 m<sup>2</sup> and drying rooms and laundries
    - ⑥ Machinery spaces of category A
      - Spaces as defined in **Ch 1, 103. 31**.
    - ⑦ Other machinery spaces
      - Electrical equipment rooms (auto-telephone exchange, air-conditioning duct spaces).  
Spaces as defined in **Ch 1, 103. 30** excluding machinery spaces of category A.
    - ⑧ Cargo spaces
      - All spaces used for cargo(including cargo oil tanks) and trunkways and hatchways to such spaces, other than special category spaces
    - ⑨ Service spaces(high risk)

Galleys, pantries containing cooking appliances, paint and lamp rooms, lockers and store-rooms having areas of 4 m<sup>2</sup> or more, spaces for the storage of flammable liquids, saunas and workshops other than those forming part of the machinery spaces

⑩ Open decks

Open deck spaces and enclosed promenades having little or no fire risk. Enclosed promenades should have no significant fire risk, meaning that furnishing should be restricted to deck furniture. In addition, such spaces should be naturally ventilated by permanent openings/  
Air spaces (the space outside superstructures and deckhouses)

⑪ Special category spaces and ro-ro spaces

Spaces as defined in **Ch 1, 103, 41 and 46.**

- (C) In determining the applicable fire integrity standard of a boundary between two spaces within a main vertical zone or horizontal zone which is not protected by an automatic sprinkler system complying with the provisions of the FSS Code or between such zones neither of which is so protected, the higher of the two values given in the tables shall apply;
- (D) In determining the applicable fire integrity standard of a boundary between two spaces within a main vertical zone or horizontal zone which is protected by an automatic sprinkler system complying with the provisions of the FSS Code or between such zones both of which are so protected, the lesser of the two values given in the tables shall apply. Where a zone with sprinklers and a zone without sprinklers meet within accommodation and service spaces, the higher of the two values given in the tables shall apply to the division between the zones;
- (3) Continuous "B" class ceilings or linings, in association with the relevant decks or bulkheads, may be accepted as contributing, wholly or in part, to the required insulation and integrity of a division.
- (4) External boundaries which are required in **Ch 9, 101.** to be of steel or other equivalent material may be pierced for the fitting of windows and sidescuttles provided that there is no requirement for such boundaries of passenger ships to have "A" class integrity. Similarly, in such boundaries which are not required to have "A" class integrity, doors may be constructed of materials which are to the satisfaction of the Society. **[See Guidance]**
- (5) Saunas shall comply with paragraph **3 (4).**

**Table 8.7.3 Fire integrity of bulkheads separating adjacent spaces (not more than 36 passengers)**

Spaces	①	②	③	④	⑤	⑥	⑦	⑧	⑨	⑩	⑪	
Control stations	①	A-0c	A-0	A-60	A-0	A-15	A-60	A-15	A-60	A-60	*	A-60
Corridors	②		Ce	B-0e	A-0a B-0e	B-0e	A-60	A-0	A-0	A-15 A-0d	*	A-30g
Accommodation spaces	③			Ce	A-0a B-0e	B-0e	A-60	A-0	A-0	A-15 A-0d	*	A-30 A-0d
Stairways	④				A-0a B-0e	A-0a B-0e	A-60	A-0	A-0	A-15 A-0d	*	A-30g
Service spaces ( low risk )	⑤					Ce	A-60	A-0	A-0	A-0	*	A-0
Machinery spaces of category A	⑥						*	A-0	A-0	A-60	*	A-60
Other Machinery spaces	⑦							A-0b	A-0	A-0	*	A-0
Cargo spaces	⑧								*	A-0	*	A-0
Service spaces ( high risk )	⑨									A-0b	*	A-30
Open decks	⑩											A-0
Special category and ro-ro spaces	⑪											A-30g

**Table 8.7.4 Fire integrity of decks separating adjacent spaces (not more than 36 passengers)**

Spaces below ↓      Space above →	①	②	③	④	⑤	⑥	⑦	⑧	⑨	⑩	⑪	
Control stations	①	A-0	A-0	A-0	A-0	A-0	A-60	A-0	A-0	A-0	*	A-60g
Corridors	②	A-0	*	*	A-0	*	A-60	A-0	A-0	A-0	*	A-30g
Accommodation spaces	③	A-60	A-0	*	A-0	*	A-60	A-0	A-0	A-0	*	A-30 A-0d
Stairways	④	A-0	A-0	A-0	*	A-0	A-60	A-0	A-0	A-0	*	A-30g
Service spaces ( low risk )	⑤	A-15	A-0	A-0	A-0	*	A-60	A-0	A-0	A-0	*	A-0
Machinery spaces of category A	⑥	A-60	A-60	A-60	A-60	A-60	*	A-60f	A-30	A-60	*	A-60
Other Machinery spaces	⑦	A-15	A-0	A-0	A-0	A-0	A-0	*	A-0	A-0	*	A-0
Cargo spaces	⑧	A-60	A-0	A-0	A-0	A-0	A-0	A-0	*	A-0	*	A-0
Service spaces ( high risk )	⑨	A-60	A-30 A-0d	A-30 A-0d	A-30 A-0d	A-0	A-60	A-0	A-0	A-0	*	A-30
Open decks	⑩	*	*	*	*	*	*	*	*	*	-	A-0
Special category and ro-ro spaces	⑪	A-60	A-30g	A-30 A-0d	A-30g	A-0	A-60g	A-0	A-0	A-30	A-0	A-30g

Notes : To be applied to both **Tables 8.7.3** and **8.7.4** as appropriate.

- a. For clarification as to which applies, see **2** and **5**.
- b. Where spaces are of the same numerical category and superscript b appears, a bulkhead or deck of the rating shown in the tables is only required when the adjacent spaces are for a different purpose (e.g. in category ⑨). A galley next to a galley does not require a bulkhead but a galley next to a paint room requires an "A-0" bulkhead.
- c. Bulkhead separating the wheelhouse and chartroom from each other may have a "B-0" rating. No fire rating is required for those partitions separating the navigation bridge and the safety centre when the latter is within the navigation bridge.
- d. See paragraphs (2) (C) and (2) (D).
- e. For the application of paragraph **1** (1) (B) "B-0" and "C", where appearing in **Table 8.7.3**, shall be read as "A-0".
- f. Fire insulation need not be fitted if the machinery space in category ⑦, in the opinion of the Society, has little or no fire risk. Spaces having little or no fire risk as defined by paragraphs ⑩ of **3** (2) (B).
- g. The ships constructed (the expression ships constructed means ships the keels of which are laid or which are at a similar stage at construction) before 1 July 2014 shall comply, as a minimum, with the previous requirements applicable at the time the ship was constructed.
- \* Where an asterisk appears in the tables, the division is required to be of steel or other equivalent material, but is not required to be of "A" class standard. However, where a deck, except in a category ⑩ space, is penetrated for the passage of electric cables, pipes and vent ducts, such penetrations should be made tight to prevent the passage of flame and smoke. Divisions between control stations (emergency generators) and open decks may have air intake openings without means for closure, unless a fixed gas fire-fighting system is fitted. For the application of paragraph **1** (1) (B), an asterisk, where appearing in **Table 8.7.4**, except for categories ⑧ and ⑩, shall be read as "A-0".

**5. Protection of stairways and lifts in accommodation area**

- (1) Stairways shall be within enclosures formed of "A" class divisions, with positive means of closure at all openings, except that:
  - (A) a stairway connecting only two decks need not be enclosed, provided the integrity of the deck is maintained by proper bulkheads or self-closing doors in one 'tween-deck space. When a stairway is closed in one 'tween-deck space, the stairway enclosure shall be protected in accordance with the tables for decks in paragraphs **3** or **4**; and
  - (B) stairways may be fitted in the open in a public space, provided they lie wholly within the public space.
- (2) Lift trunks shall be so fitted as to prevent the passage of smoke and flame from one 'tween-deck to another and shall be provided with means of closing so as to permit the control of draught and smoke. Machinery for lifts located within stairway enclosures shall be arranged in a separate room, surrounded by steel boundaries, except that small passages for lift cables are permitted. Lifts which open into spaces other than corridors, public spaces, special category spaces, stairways and external areas shall not open into stairways included in the means of escape.



## 6. Arrangement of cabin balconies

Non-load bearing partial bulkheads which separate adjacent cabin balconies shall be capable of being opened by the crew from each side for the purpose of fighting fires.

## 7. Protection of atriums is to comply with the following requirements

- (1) Atriums shall be within enclosures of "A" class divisions having a fire rating determined in accordance with **Tables 8.7.2** and **8.7.4**, as applicable.
- (2) Decks separating spaces within atriums shall have a fire rating determined in accordance with **Tables 8.7.2** and **8.7.4**, as applicable.

## 103. Cargo Ships except tankers

### 1. Methods of protection in accommodation

- (1) One of the following methods of protection shall be adopted in accommodation and service spaces and control stations:
  - (A) Method IC  
The construction of internal divisional bulkheads of non-combustible "B" or "C" class divisions generally without the installation of an automatic sprinkler, fire detection and fire alarm system in the accommodation and service spaces, except as required by **Ch5, 305. 1**;
  - (B) Method IIC  
The fitting of an automatic sprinkler, fire detection and fire alarm system as required by **Ch5, 305. 2** for the detection and extinction of fire in all spaces in which fire might be expected to originate, generally with no restriction on the type of internal divisional bulkheads; or
  - (C) Method IIIC  
The fitting of a fixed fire detection and fire alarm system as required by **Ch5, 305. 3** in spaces in which a fire might be expected to originate, generally with no restriction on the type of internal divisional bulkheads, except that in no case must the area of any accommodation space or spaces bounded by an "A" or "B" class division exceed 50 m<sup>2</sup>. Consideration may be given by the Society to increasing this area for public spaces.  
**[See Guidance]**
- (2) The requirements for the use of non-combustible materials in the construction and insulation of boundary bulkheads of machinery spaces, control stations, service spaces, etc., and the protection of the above stairway enclosures and corridors will be common to all three methods outlined in (1).

### 2. Bulkheads within accommodation area

- (1) Bulkheads required to be "B" class divisions shall extend from deck to deck and to the shell or other boundaries. However, where a continuous "B" class ceiling or lining is fitted on both sides of the bulkhead, the bulkhead may terminate at the continuous ceiling or lining.
- (2) Method IC  
Bulkheads not required by this or other regulations for cargo ships to be "A" or "B" class divisions, shall be of at least "C" class construction.
- (3) Method IIC  
There shall be no restriction on the construction of bulkheads not required by this or other regulations for cargo ships to be "A" or "B" class divisions except in individual cases where "C" class bulkheads are required in accordance with **Table 8.7.5**.
- (4) Method IIIC  
There shall be no restriction on the construction of bulkheads not required for cargo ships to be "A" or "B" class divisions except that the area of any accommodation space or spaces bounded by a continuous "A" or "B" class division must in no case exceed 50 m<sup>2</sup>, except in individual cases where "C" class bulkheads are required in accordance with **Table 8.7.5**. Consideration may be given by the Society to increasing this area for public spaces.

### 3. Fire integrity of bulkheads and decks

- (1) In addition to complying with the specific provisions for fire integrity of bulkheads and decks of cargo ships, the minimum fire integrity of bulkheads and decks shall be as prescribed in **Tables 8.7.5** and **8.7.6**.
- (2) The following requirements shall govern application of the tables:

- (A) **Tables 8.7.5** and **8.7.6** shall apply respectively to the bulkheads and decks separating adjacent spaces.
- (B) For determining the appropriate fire integrity standards to be applied to divisions between adjacent spaces, such spaces are classified according to their fire risk as shown in categories ① to ⑪ below. Where the contents and use of a space are such that there is a doubt as to its classification for the purpose of this regulation, or where it is possible to assign two or more classifications to a space, it shall be treated as a space within the relevant category having the most stringent boundary requirements. Smaller, enclosed rooms within a space that have less than 30% communicating openings to that space are considered separate spaces. In this connection, locker rooms, lavatories for control station, etc., only having entrance therefrom, whose area of divisions, may be regarded as an integral part of such space. The fire integrity of the boundary bulkheads and decks of such smaller rooms shall be as prescribed in **Tables 8.7.5** and **8.7.6**. The title of each category is intended to be typical rather than restrictive. The number in parentheses preceding each category refers to the applicable column or row in the tables.
- ① Control stations
    - Spaces containing emergency sources of power and lighting.
    - Wheelhouse and chartroom.
    - Spaces containing the ship's radio equipment.
    - Fire control stations.
    - Control room for propulsion machinery when located outside the machinery space.
    - Spaces containing centralized fire alarm equipment.
  - ② Corridors
    - corridors and lobbies.
  - ③ Accommodation spaces
    - Spaces as defined in **Ch 1, 103. 1** excluding corridors.
  - ④ Stairways
    - Interior stairway, lifts, totally enclosed emergency escape trunks, and escalators (other than those wholly contained within the machinery spaces) and enclosures thereto.
    - In this connection, a stairway which is enclosed only at one level shall be regarded as part of the space from which it is not separated by a fire door.
  - ⑤ Service spaces(low risk)
    - Lockers and store-rooms not having provisions for the storage of flammable liquids and having areas less than 4 m<sup>2</sup> and drying rooms and laundries.
  - ⑥ Machinery spaces of category A
    - Spaces as defined in **Ch 1, 103. 31**.
  - ⑦ Other machinery spaces
    - Electrical equipment rooms (auto-telephone exchange, air-conditioning duct spaces)/
    - Spaces as defined in **Ch 1, 103. 30** excluding machinery spaces of category A.
  - ⑧ Cargo spaces
    - All spaces used for cargo(including cargo oil tanks) and trunkways and hatchways to such spaces
  - ⑨ Service spaces(high risk)
    - Galleys, pantries containing cooking appliances, saunas, paint lockers and store-rooms having areas of 4 m<sup>2</sup> or more, spaces for the storage of flammable liquids, and work shops other than those forming part of the machinery spaces.
  - ⑩ Open decks
    - Open deck spaces and enclosed promenades having little or no fire risk. To be considered in this category, enclosed promenades shall have no significant fire risk, meaning that furnishings shall be restricted to deck furniture. In addition, such spaces shall be naturally ventilated by permanent openings/
    - Air spaces(the space outside superstructures and deckhouses).
  - ⑪ Ro-ro and vehicle spaces
    - Ro-ro spaces and Vehicle spaces as defined in **Ch 1, 103. 41** and **49**.

Table 8.7.5 Fire integrity of bulkheads separating adjacent spaces(Cargo Ships except tankers)

Spaces	①	②	③	④	⑤	⑥	⑦	⑧	⑨	⑩	⑪	
Control stations	①	A-0e	A-0	A-60	A-0	A-15	A-60	A-15	A-60	A-60	*	A-60
Corridors	②		C	B-0	B-0 A-0c	B-0	A-60	A-0	A-0	A-0	*	A-30
Accommodation spaces	③			Ca,b	B-0 A-0c	B-0	A-60	A-0	A-0	A-0	*	A-30
Stairways	④				B-0 A-0c	B-0 A-0c	A-60	A-0	A-0	A-0	*	A-30
Service spaces (low risk)	⑤				C	A-60	A-0	A-0	A-0	A-0	*	A-0
Machinery spaces of category A	⑥					*	A-0	A-0g	A-60	A-60	*	A-60f
Other machinery spaces	⑦						A-0d	A-0	A-0	A-0	*	A-0
Cargo spaces	⑧							*	A-0	A-0	*	A-0
Service spaces (high risk)	⑨								A-0d	A-0	*	A-30
Open decks	⑩										-	A-0
Ro-ro spaces and vehicle spaces	⑪											A-30i

Table 8.7.6 Fire integrity of decks separating adjacent space (Cargo Ships except tankers)

Spaces below ↓	Space above →	①	②	③	④	⑤	⑥	⑦	⑧	⑨	⑩	⑪
Control stations	①	A-0	A-0	A-0	A-0	A-0	A-60	A-0	A-0	A-0	*	A-60
Corridors	②	A-0	*	*	A-0	*	A-60	A-0	A-0	A-0	*	A-30
Accommodation spaces	③	A-60	A-0	*	A-0	*	A-60	A-0	A-0	A-0	*	A-30
Stairways	④	A-0	A-0	A-0	*	A-0	A-60	A-0	A-0	A-0	*	A-30
Service spaces (low risk)	⑤	A-15	A-0	A-0	A-0	*	A-60	A-0	A-0	A-0	*	A-0
Machinery spaces of category A	⑥	A-60	A-60	A-60	A-60	A-60	*	A-60h	A-30	A-60	*	A-60
Other machinery spaces	⑦	A-15	A-0	A-0	A-0	A-0	A-0	*	A-0	A-0	*	A-0
Cargo spaces	⑧	A-60	A-0	A-0	A-0	A-0	A-0	A-0	*	A-0	*	A-0
Service spaces (high risk)	⑨	A-60	A-0	A-0	A-0	A-0	A-60	A-0	A-0	A-0d	*	A-30
Open decks	⑩	*	*	*	*	*	*	*	*	*	-	A-0i
Ro-ro spaces and vehicle spaces	⑪	A-60	A-30	A-30	A-30	A-0	A-60	A-0	A-0	A-30	A-0i	A-30i

Note: To be applied to **Tables 8.7.5** and **8.7.6** as appropriate.

- a. No special requirements are imposed upon bulkheads in methods IIC and IIIC fire protection.
  - b. In case of method IIIC "B" class bulkheads of "B-0" rating shall be provided between spaces or groups of spaces of 50 m<sup>2</sup> and over in area.
  - c. For clarification as to which applies, see paragraphs **2** and **4**.
  - d. Where spaces are of the same numerical category and superscript d appear, a bulkhead or deck of the rating shown in the tables is only required when the adjacent spaces are for a different purpose(e.g. in category ⑨). A galley next to a galley does not require a bulkhead but a galley next to a paint room requires an "A-0" bulkhead.
  - e. Bulkheads separating the wheelhouse, chartroom and radio room from each other may have a "B-0" rating.
  - f. An "A-0" rating may be used if no dangerous goods are intended to be carried or if such goods are stowed not less than 3 m horizontally from such a bulkhead.
  - g. For cargo spaces in which dangerous goods are intended to be carried, **Ch 12, 201. 8** applies.
  - h. Fire insulation need not be fitted if the machinery in category ⑦. if, in the opinion of the Society, it has little or no fire risk. Spaces having little or no fire risk as defined by ⑩ of **102. 3 (2) (B)**.
  - i. The ships constructed(the expression ships constructed means ships the keels of which are laid or which are at a similar stage at construction) before 1 July 2014 shall comply, as a minimum, with the previous requirements applicable at the time the ship was constructed.
- \* Where an asterisk appears in the tables, the division is required to be of steel or other equivalent material but is not required to be of "A" class standard. However, where a deck, except an open deck, is penetrated for the passage of electric cables, pipes and vent ducts, such penetrations should be made tight to prevent the passage of flame and smoke. Divisions between control stations (emergency generators) and open decks may have air intake openings without means for closure, unless a fixed gas fire-fighting system is fitted.

- (3) Continuous "B" class ceilings or linings, in association with the relevant decks or bulkheads, may be accepted as contributing, wholly or in part, to the required insulation and integrity of a division.
- (4) External boundaries which are required in **Ch 9, 101.** to be of steel or other equivalent material may be pierced for the fitting of windows and sidescuttles provided that there is no requirement for such boundaries of cargo ships to have "A" class integrity. Similarly, in such boundaries which are not required to have "A" class integrity, doors may be constructed of materials which are to the satisfaction of the Society. **【See Guidance】**
- (5) Saunas shall comply with **102. 3(4).**

#### 4. Protection of stairways and lift trunks in accommodation spaces, service spaces and control stations

- (1) Stairways which penetrate only a single deck shall be protected, at a minimum, at one level by at least "B-0" class divisions and self-closing doors. Lifts which penetrate only a single deck shall be surrounded by "A-0" class divisions with steel doors at both levels. Stairways and lift trunks which penetrate more than a single deck shall be surrounded by at least "A-0" class divisions and be protected by self-closing doors at all levels. **【See Guidance】**
- (2) On ships having accommodation for 12 persons or less, where stairways penetrate more than a single deck and where there are at least two escape routes direct to the open deck at every accommodation level, the "A-0" requirements of (1) may be reduced to "B-0".

### 104. Tankers

1. For tankers, only method IC as defined in **103. 1 (1)** shall be used.

#### 2. Fire integrity of bulkheads and decks

- (1) the minimum fire integrity of bulkheads and decks shall be as prescribed in **Tables 8.7.7 and 8.7.8.**
- (2) The following requirements shall govern application of the tables:
  - (A) **Tables 8.7.7 and 8.7.8** shall apply respectively to the bulkhead and decks separating adjacent spaces;
  - (B) For determining the appropriate fire integrity standards to be applied to divisions between adjacent spaces, such spaces are classified according to their fire risk as shown in categories ① to ⑩ below. Where the contents and use of a space are such that there is a doubt as to its classification for the purpose of this regulation, or where it is possible to assign two or more classifications to a space, it shall be treated as a space within the relevant category having the most stringent boundary requirements. Smaller, enclosed areas within a space that have less than 30 % communicating openings to that space are considered separate areas. The fire integrity of the boundary bulkheads and decks of such smaller spaces shall be as prescribed in **Tables 8.7.7 and 8.7.8.** The number in parentheses preceding each category refers to the applicable column or row in the tables ;
    - ① Control stations  
Spaces containing emergency sources of power and lighting/  
Wheelhouse and chartroom/  
Spaces containing the ship's radio equipment/  
Fire control stations/  
Control room for propulsion machinery when located outside the machinery space/  
Spaces containing centralized fire alarm equipment
    - ② Corridors  
Corridors and lobbies
    - ③ Accommodation spaces  
Spaces as defined in **Ch 1, 103. 1** excluding corridors
    - ④ Stairways  
Interior stairways, lifts, totally enclosed emergency escape trunks, and escalators (other than those wholly contained within the machinery spaces) and enclosures thereto. In this connection, a stairway which is enclosed only at one level shall be regarded as part of the space from which it is not separated by a fire door.
    - ⑤ Service spaces(low risk)  
Lockers and store-rooms not having provisions for the storage of flammable liquids and having areas less than 4 m<sup>2</sup> and drying rooms and laundries
    - ⑥ Machinery spaces of category A

- Spaces as defined in **Ch 1, 103. 31**
- ⑦ Other machinery spaces  
Electrical equipment rooms(auto-telephone exchange and air-conditioning duct spaces)/  
Spaces as defined in **Ch 1, 103. 30** excluding machinery spaces of category A.
  - ⑧ Cargo pump-rooms  
Spaces containing cargo pumps and entrances and trunks to such spaces
  - ⑨ Service spaces(high risk)  
Galleys, pantries containing cooking appliances, saunas, paint lockers and store-rooms  
having areas of 4 m<sup>2</sup> or more, spaces for the storage of flammable liquids and work  
shops other than those forming part of the machinery spaces
  - ⑩ Open decks  
Open deck spaces and enclosed promenades having little or no fire risk. To be consid-  
ered in this category, enclosed promenades shall have no significant fire risk, meaning  
that furnishings shall be restricted to deck furniture. In addition, such spaces shall be  
naturally ventilated by permanent openings/  
Air spaces(the space outside superstructures and deckhouses)
- (3) Continuous "B" class ceilings or linings, in association with the relevant decks or bulkheads, may  
be accepted as contributing, wholly or in part, to the required insulation and integrity of a  
division.
- (4) External boundaries which are required in **Ch 9, 101.** to be of steel or other equivalent material  
may be pierced for the fitting of windows and sidescuttles provided that there is no requirement  
for such boundaries of tankers to have "A" class integrity. Similarly, in such boundaries which are  
not required to have "A" class integrity, doors may be constructed of materials which are to the  
satisfaction of the Society. **【See Guidance】**
- (5) Exterior boundaries of superstructures and deckhouses enclosing accommodation and including  
any overhanging decks which support such accommodation, shall be constructed of steel and in-  
sulated to "A-60" standard for the whole of the portions which face the cargo area and on the  
outward sides for a distance of 3 m from the end boundary facing the cargo area. The distance  
of 3 m shall be measured horizontally and parallel to the middle line of the ship from the boun-  
dary which faces the cargo area at each deck level. In the case of the sides of those super-  
structures and deckhouses, such insulation shall be carried up to the underside of the deck of  
the navigation bridge. **【See Guidance】**
- (6) Skylights to cargo pump-rooms shall be of steel, shall not contain any glass and shall be capa-  
ble of being closed from outside the pump-room.
- (7) Construction and arrangement of saunas shall comply with **102. 3(4).**

**Table 8.7.7 Fire integrity of bulkheads separating adjacent spaces (Tankers)**

Spaces	①	②	③	④	⑤	⑥	⑦	⑧	⑨	⑩	
Control stations	①	A-0c	A-0	A-60	A-0	A-15	A-60	A-15	A-60	A-60	*
Corridors	②		C	B-0	B-0 A-0a	B-0	A-60	A-0	A-60	A-0	*
Accommodation spaces	③			C	B-0 A-0a	B-0	A-60	A-0	A-60	A-0	*
Stairways	④				B-0 A-0a	B-0 A-0a	A-60	A-0	A-60	A-0	*
Service spaces (low risk)	⑤					C	A-60	A-0	A-60	A-0	*
Machinery spaces of category A	⑥					*	A-0	A-0d	A-60	A-60	*
Other machinery spaces	⑦						A-0b	A-0	A-0	A-0	*
Cargo pump-rooms	⑧							*	A-60	A-60	*
Service spaces (high risk)	⑨								A-0b	A-0b	*
Open decks	⑩										-

**Table 8.7.8 Fire integrity of decks separating adjacent space (Tankers)**

Spaces below ↓      Space above →		①	②	③	④	⑤	⑥	⑦	⑧	⑨	⑩
Control stations	①	A-0	A-0	A-0	A-0	A-0	A-60	A-0	-	A-0	*
Corridors	②	A-0	*	*	A-0	*	A-60	A-0	-	A-0	*
Accommodation spaces	③	A-60	A-0	*	A-0	*	A-60	A-0	-	A-0	*
Stairways	④	A-0	A-0	A-0	*	A-0	A-60	A-0	-	A-0	*
Service spaces (low risk)	⑤	A-15	A-0	A-0	A-0	*	A-60	A-0	-	A-0	*
Machinery spaces of category A	⑥	A-60	A-60	A-60	A-60	A-60	*	A-60e	A-0	A-60	*
Other machinery spaces	⑦	A-15	A-0	A-0	A-0	A-0	A-0	*	A-0	A-0	*
Cargo pump-rooms	⑧	-	-	-	-	-	A-0d	A-0	*	-	*
Service spaces (high risk)	⑨	A-60	A-0	A-0	A-0	A-0	A-60	A-0	-	A-0b	*
Open decks	⑩	*	*	*	*	*	*	*	*	*	-

Notes: To be applied to **Tables 8.7.7** and **8.7.8** as appropriate.

- a. For clarification as to which applies, see **103. 3** and **4**.
- b. Where spaces are of the same numerical category and superscript b appears, a bulkhead or deck of the rating shown in the tables is only required when the adjacent spaces are for a different purpose (e.g. in category ⑨). A galley next to a galley does not require a bulkhead but a galley next to a paint room requires an "A-0" bulkhead.
- c. Bulkheads separating the wheelhouse, chartroom and radio room from each other may have a "B-0" rating.
- d. Bulkheads and decks between cargo pump-rooms and machinery spaces of category A may be penetrated by cargo pump shaft glands and similar gland penetrations, provided that gas tight seals with efficient lubrication or other means of ensuring the permanence of the gas seal are fitted in way of the bulkheads or deck.
- e. Fire insulation need not be fitted if the machinery space in category ⑦ if, in the opinion of the Society, it has little or no fire risk. Spaces having little or no fire risk as defined by ⑩ of **102. 3** (2) (B).
- \* Where an asterisk appears in the table, the division is required to be of steel or other equivalent material, but is not required to be of "A" class standard. However, where a deck, except an open deck, is penetrated for the passage of electric cables, pipes and vent ducts, such penetrations should be made tight to prevent the passage of flame and smoke. Divisions between control stations (emergency generators) and open decks may have air intake openings without means for closure, unless a fixed gas fire-fighting system is fitted.

## Section 2 Penetration in Fire-resisting Divisions and Prevention of Heat Transmission

### 201. Penetration in fire-resisting divisions and prevention of heat transmission [See Guidance]

1. Where "A" class divisions are penetrated, such penetrations shall be tested in accordance with the FTP Code, subject to the provisions of **301. 1** (6). In the case of ventilation ducts, **601. 2** and **603. 1** apply. However, where a pipe penetration is made of steel or equivalent material having a thickness of 3 mm or greater and a length of not less than 900 mm (preferably 450 mm on each side of the division), and no openings, testing is not required. Such penetrations shall be suitably insulated by extension of the insulation at the same level of the division.
2. Where "B" class divisions are penetrated for the passage of electric cables, pipes, trunks, ducts, etc., or for the fitting of ventilation terminals, lighting fixtures and similar devices, arrangements shall be made to ensure that the fire resistance is not impaired, subject to the provisions of **603. 2**. Pipes other than steel or copper that penetrate "B" class divisions shall be protected by either:
  - (1) a fire tested penetration device, suitable for the fire resistance of the division pierced and the type of pipe used; or
  - (2) a steel sleeve, having a thickness of not less than 1.8 mm and a length of not less than 900 mm for pipe diameters of 150 mm or more and not less than 600 mm for pipe diameters of less than 150 mm (preferably equally divided to each side of the division). The pipe shall be connected to the ends of the sleeve by flanges or couplings; or the clearance between the sleeve and the pipe shall not exceed 2.5 mm; or any clearance between pipe and sleeve shall be made tight by

means of non-combustible or other suitable material.

3. Uninsulated metallic pipes penetrating "A" or "B" class divisions shall be of materials having a melting temperature which exceeds 950 °C for "A-0" and 850 °C for "B-0" class divisions.
4. In approving structural fire protection details, the Society shall have regard to the risk of heat transmission at intersections and terminal points of required thermal barriers. The insulation of a deck or bulkhead shall be carried past the penetration, intersection or terminal point for a distance of at least 450 mm in the case of steel and aluminium structures. If a space is divided with a deck or a bulkhead of "A" class standard having insulation of different values, the insulation with the higher value shall continue on the deck or bulkhead with the insulation of the lesser value for a distance of at least 450 mm.

## Section 3 Protection of Openings in Fire-resisting Divisions

### 301. Openings in bulkheads and decks in passenger ships

#### 1. Openings in "A" class divisions

- (1) Except for hatches between cargo, special category, store, and baggage spaces, and between such spaces and the weather decks, openings shall be provided with permanently attached means of closing which shall be at least as effective for resisting fires as the divisions in which they are fitted.
- (2) The construction of doors and door frames in "A" class divisions, with the means of securing them when closed, shall provide resistance to fire as well as to the passage of smoke and flame equivalent to that of the bulkheads in which the doors are situated, this being determined in accordance with the FTP Code. Such doors and door frames shall be constructed of steel or other equivalent material. Doors approved without the sill being part of the frame shall be installed such that the gap under the door does not exceed 12 mm. A non-combustible sill shall be installed under the door such that floor coverings do not extend beneath the closed door.
- (3) Watertight doors need not be insulated.
- (4) It shall be possible for each door to be opened and closed from each side of the bulkhead by one person only.
- (5) Fire doors in main vertical zone bulkheads, galley boundaries and stairway enclosures other than power-operated watertight doors and those which are normally locked, shall satisfy the following requirements:
  - (A) the doors shall be self-closing and be capable of closing with an angle of inclination of up to 3.5° opposing closure;
  - (B) the approximate time of closure for hinged fire doors shall be no more than 40s and no less than 10s from the beginning of their movement with the ship in upright position. The approximate uniform rate of closure for sliding doors shall be of no more than 0.2 m/s and no less than 0.1 m/s with the ship in upright position;
  - (C) the doors, except those for emergency escape trunks, shall be capable of remote release from the continuously manned central control station, either simultaneously or in groups and shall be capable of release also individually from a position at both sides of the door. Release switches shall have an on-off function to prevent automatic resetting of the system;
  - (D) hold-back hooks not subject to central control station release are prohibited;
  - (E) a door closed remotely from the central control station shall be capable of being re-opened from both sides of the door by local control. After such local opening, the door shall automatically close again;
  - (F) indication must be provided at the fire door indicator panel in the continuously manned central control station whether each door is closed;
  - (G) the release mechanism shall be so designed that the door will automatically close in the event of disruption of the control system or central power supply;
  - (H) local power accumulators for power-operated doors shall be provided in the immediate vicinity of the doors to enable the doors to be operated after disruption of the control system or central power supply at least ten times (fully opened and closed) using the local controls;
  - (I) disruption of the control system or central power supply at one door shall not impair the safe functioning of the other doors;

- (J) remote-released sliding or power-operated doors shall be equipped with an alarm that sounds at least 5s but no more than 10s after the door being released from the central control station and before the door begins to move and continues sounding until the door is completely closed;
- (K) a door designed to re-open upon contacting an object in its path shall re-open not more than 1 m from the point of contact;
- (L) double-leaf doors equipped with a latch necessary for their fire integrity shall have a latch that is automatically activated by the operation of the doors when released by the system;
- (M) doors giving direct access to special category spaces which are power-operated and automatically closed need not be equipped with the alarms and remote-release mechanisms required in paragraphs (C) and (J);
- (N) the components of the local control system shall be accessible for maintenance and adjusting;
- (O) power-operated doors shall be provided with a control system of an approved type which shall be able to operate in case of fire and be in accordance with the FTP Code. This system shall satisfy the following requirements:
  - (a) the control system shall be able to operate the door at the temperature of at least 200 °C for at least 60 min, served by the power supply;
  - (b) the power supply for all other doors not subject to fire shall not be impaired; and
  - (c) at temperatures exceeding 200 °C the control system shall be automatically isolated from the power supply and shall be capable of keeping the door closed up to at least 945 °C.
- (6) In ships carrying not more than 36 passengers, where a space is protected by an automatic sprinkler fire detection and alarm system complying with the provisions the FSS Code or fitted with a continuous "B" class ceiling, openings in decks not forming steps in main vertical zones nor bounding horizontal zones shall be closed reasonably tight and such decks shall meet the "A" class integrity requirements in so far as is reasonable and practicable in the opinion of the Society.
- (7) The requirements for "A" class integrity of the outer boundaries of a ship shall not apply to glass partitions, windows and sidescuttles, provided that there is no requirement for such boundaries to have "A" class integrity in paragraph 3 (3). The requirements for "A" class integrity of the outer boundaries of the ship shall not apply to exterior doors, except for those in superstructures and deckhouses facing lifesaving appliances, embarkation and external assembly station areas, external stairs and open decks used for escape routes. Stairway enclosure doors need not meet this requirement. **【See Guidance】**
- (8) Except for watertight doors, weathertight doors(semi-watertight doors), doors leading to the open deck and doors which need to be reasonably gastight, all "A" class doors located in stairways, public spaces and main vertical zone bulkheads in escape routes shall be equipped with a self-closing hose port of material, construction and fire resistance which is equivalent to the door into which it is fitted, and shall be a 150 mm square clear opening with the door closed and shall be inset into the lower edge of the door, opposite the door hinges or, in the case of sliding doors, nearest the opening.
- (9) Where it is necessary that a ventilation duct passes through a main vertical zone division, a fail-safe automatic closing fire damper shall be fitted adjacent to the division. The damper shall also be capable of being manually closed from each side of the division. The operating position shall be readily accessible and be marked in red light-reflecting colour. The duct between the division and the damper shall be of steel or other equivalent material and, if necessary, insulated to comply with the requirements of 201. 1. The damper shall be fitted on at least one side of the division with a visible indicator showing whether the damper is in the open position.

## 2. Openings in "B" class divisions **【See Guidance】**

- (1) Doors and door frames in "B" class divisions and means of securing them shall provide a method of closure which shall have resistance to fire equivalent to that of the divisions, this being determined in accordance with the FTP Code except that ventilation openings may be permitted in the lower portion of such doors. Where such opening is in or under a door the total net area of any such opening or openings shall not exceed 0.05 m<sup>2</sup>. Alternatively, a non-combustible air balance duct routed between the cabin and the corridor, and located below the sanitary unit is permitted where the cross-sectional area of the duct does not exceed 0.05 m<sup>2</sup>. All ventilation openings shall be fitted with a grill made of non-combustible material. Doors shall be non-combustible. Doors approved without the sill being part of the frame shall be installed such that the gap under the door does not exceed 25 mm.



- (2) Cabin doors in "B" class divisions shall be of a self-closing type. Hold-back hooks are not permitted.
- (3) The requirements for "B" class integrity of the outer boundaries of a ship shall not apply to glass partitions, windows and sidescuttles. Similarly, the requirements for "B" class integrity shall not apply to exterior doors in superstructures and deckhouses. For ships carrying not more than 36 passengers, the Society may permit the use of combustible materials in doors separating cabins from the individual interior sanitary spaces such as showers.
- (4) In ships carrying not more than 36 passengers, where an automatic sprinkler system complying with the provisions of the FSS Code is fitted:
  - (A) openings in decks not forming steps in main vertical zones nor bounding horizontal zones shall be closed reasonably tight and such decks shall meet the "B" class integrity requirements in so far as is reasonable and practicable in the opinion of the Society; and
  - (B) openings in corridor bulkheads of "B" class materials shall be protected in accordance with the provisions of **102. 1**.

### 3. Windows and side scuttles

- (1) Windows and side scuttles in bulkheads within accommodation and service spaces and control stations other than those to which the provisions of paragraph **1 (6)** and **2 (3)** apply, shall be so constructed as to preserve the integrity requirements of the type of bulkheads in which they are fitted, this being determined in accordance with the FTP Code.
- (2) Notwithstanding the requirements of **Tables 8.7.1 to 8.7.4**, windows and sidescuttles in bulkheads separating accommodation and service spaces and control stations from weather shall be constructed with frames of steel or other suitable material. The glass shall be retained by a metal glazing bead or angle.
- (3) Windows facing life-saving appliances, embarkation and assembly stations, external stairs and open decks used for escape routes, and windows situated below liferaft and escape slide embarkation areas shall have fire integrity as required in **Table 8.7.1**. Windows located in the ship's side below the lifeboat embarkation area shall have fire integrity at least equal to "A-0" class. Where automatic dedicated sprinkler heads are provided for windows, "A-0" windows may be accepted as equivalent. To be considered under this paragraph, the sprinkler heads must either be : **[See Guidance]**
  - (A) dedicated heads located above the windows, and installed in addition to the conventional ceiling sprinklers; or
  - (B) conventional ceiling sprinkler heads arranged such that the window is protected by an average application rate of at least  $5 \text{ L}/(\text{min} \cdot \text{m}^2)$  and the additional window area is included in the calculation of the area of coverage; or
  - (C) water-mist nozzles that have been tested and approved in accordance with the guidelines approved by the IMO.
- (4) Notwithstanding the requirements of (3), for ships carrying not more than 36 passengers, windows facing survival craft and escape slide, embarkation areas and windows situated below such areas shall have fire integrity at least equal to "A-0" class. (2023)

### 302. Doors in fire-resisting divisions in cargo ships **[See Guidance]**

1. The fire resistance of doors shall be equivalent to that of the division in which they are fitted, this being determined in accordance with the FTP Code. Doors approved as "A" class without the sill being part of the frame shall be installed such that the gap under the door does not exceed 12 mm and a non-combustible sill shall be installed under the door such that floor coverings do not extend beneath the closed door. Doors approved as "B" class without the sill being part of the frame shall be installed such that the gap under the door does not exceed 25 mm. Doors and door frames in "A" class divisions shall be constructed of steel. Doors in "B" class divisions shall be non-combustible. Doors fitted in boundary bulkheads of machinery spaces of category A shall be reasonably gastight and self-closing. In ships constructed according to method IC, the Society may permit the use of combustible materials in doors separating cabins from individual interior sanitary accommodation such as showers.
2. Doors required to be self-closing shall not be fitted with hold-back hooks. However, hold-back arrangements fitted with remote release devices of the fail-safe type may be utilized.
3. In corridor bulkheads ventilation openings may be permitted in and under the doors of cabins and public spaces. Ventilation openings are also permitted in "B" class doors leading to lavatories, off-

ces, pantries, lockers and store rooms. Except as permitted below, the openings shall be provided only in the lower half of a door. Where such an opening is in or under a door the total net area of any such opening or openings shall not exceed 0.05 m<sup>2</sup>. Alternatively, a non-combustible air balance duct routed between the cabin and the corridor, and located below the sanitary unit is permitted where the cross-sectional area of the duct does not exceed 0.05 m<sup>2</sup>. Ventilation openings, except those under the door, shall be fitted with a grille made of non-combustible material.

4. Watertight doors need not be insulated.

## Section 4 Protection of Openings In Machinery Space Boundaries

### 401. Application

The provision of this paragraph shall apply to machinery spaces of category A and to other machinery spaces.

### 402. Protection of openings in machinery space boundaries

1. The number of skylights, doors, ventilators, openings in funnels to permit exhaust ventilation and other openings to machinery spaces shall be reduced to a minimum consistent with the needs of ventilation and the proper and safe working of the ship.
2. Skylights shall be of steel and shall not contain glass panels.
3. Means of control shall be provided for closing power-operated doors or actuating release mechanisms on doors other than power-operated watertight doors. The control shall be located outside the space concerned, where they will not be cut off in the event of fire in the space it serves.
4. In passenger ships, the means of control required in paragraph 3 shall be situated at one control position or grouped in as few positions as possible to the satisfaction of the Society. Such positions shall have safe access from the open deck.
5. In passenger ships, doors, other than power-operated watertight doors shall be so arranged that positive closure is assured in case of fire in the space by power-operated closing arrangements or by the provision of self-closing doors capable of closing against an inclination of 3.5° opposing closure, and having a fail-safe hold-back arrangement, provided with a remotely operated release device. Doors for emergency escape trunks need not be fitted with a fail-safe hold-back facility and a remotely operated release device.
6. Windows shall not be fitted in machinery space boundaries. However, this does not preclude the use of glass in control rooms within the machinery spaces.

## Section 5 Protection of Cargo Space Boundaries

### 501. Protection of cargo space boundaries

1. In passenger ships carrying **more than 36 passengers**, the boundary bulkheads and decks of special category and ro-ro spaces shall be insulated to "A-60" class standard. However, where a category ⑤, ⑨, ⑩ space, as defined in 102. 3 (2), is on one side of the division the standard may be reduced to "A-0". Where fuel oil tanks are below a special category space, the integrity of the deck between such spaces may be reduced to "A-0" standard.
2. In passenger ships, indicators shall be provided on the navigating bridge which shall indicate when any fire door leading to or from the special category spaces is closed.
3. In tankers, for the protection of cargo tanks carrying crude oil and petroleum products having a flashpoint not exceeding 60 °C, materials readily rendered ineffective by heat shall not be used for valves, fittings, tank opening covers, cargo vent piping, and cargo piping so as to prevent the spread of fire to the cargo. **【See Guidance】**

## Section 6 Ventilation Systems [See Guidance]

### 601. General

1. Ventilation ducts, including single and double wall ducts, shall be of steel or equivalent material except flexible bellows of short length not exceeding 600 mm used for connecting fans to the ducting in air-conditioning rooms. Unless expressly provided otherwise in **6**, any other material used in the construction of ducts, including insulation, shall also be non-combustible. However, short ducts, not generally exceeding 2 m in length and with a free cross-sectional area not exceeding 0.02 m<sup>2</sup>, need not be of steel or equivalent material, subject to the following conditions:
  - (1) the ducts shall be made of non-combustible material, which may be faced internally and externally with membranes having low flame-spread characteristics and, in each case, a calorific value not exceeding 45 MJ/m<sup>2</sup> of their surface area for the thickness used;
  - (2) the ducts are only used at the end of the ventilation device; and
  - (3) the ducts are not situated less than 600 mm, measured along the duct, from an opening in an "A" or "B" class division, including continuous "B" class ceiling.
2. The following arrangements shall be tested in accordance with the FTP Code:
  - (1) fire dampers, including their relevant means of operation, however, the testing is not required for dampers located at the lower end of the duct in exhaust ducts for galley ranges, which must be of steel and capable of stopping the draught in the duct; and
  - (2) duct penetrations through "A" class divisions. However, the test is not required where steel sleeves are directly joined to ventilation ducts by means of riveted or screwed connections or by welding.
3. Fire dampers shall be easily accessible. Where they are placed behind ceilings or linings, these ceilings or linings shall be provided with an inspection hatch on which the identification number of the fire damper is marked. The fire damper identification number shall also be marked on any remote controls provided.
4. Ventilation ducts shall be provided with hatches for inspection and cleaning. The hatches shall be located near the fire dampers.
5. The main inlets and outlets of ventilation systems shall be capable of being closed from outside the spaces being ventilated. The means of closing shall be easily accessible as well as prominently and permanently marked and shall indicate the operating position of the closing device.
6. Combustible gaskets in flanged ventilation duct connections are not permitted within 600 mm of openings in "A" or "B" class divisions and in ducts required to be of "A" class construction.
7. Ventilation openings or air balance ducts between two enclosed spaces shall not be provided except as permitted by **301. 2 (1)** and **302. 3**.

### 602. Arrangement of ducts

1. The ventilation systems for machinery spaces of category A, vehicle spaces, ro-ro spaces, galleys, special category spaces and cargo spaces shall, in general, be separated from each other and from the ventilation systems serving other spaces. However, the galley ventilation systems on cargo ships of less than 4,000 gross tonnage and in passenger ships carrying not more than 36 passengers need not be completely separated from other ventilation systems, but may be served by separate ducts from a ventilation unit serving other spaces. In such a case, an automatic fire damper shall be fitted in the galley ventilation duct near the ventilation unit.
2. Ducts provided for the ventilation of machinery spaces of category A, galleys, vehicle spaces, ro-ro spaces or special category spaces shall not pass through accommodation spaces, service spaces, or control stations unless they comply with **4**.
3. Ducts provided for the ventilation of accommodation spaces, service spaces or control stations shall not pass through machinery spaces of category A, galleys, vehicle spaces, ro-ro spaces or special category spaces unless they comply with **4**.
4. As permitted by **2** and **3** ducts shall be either:
  - (1) constructed of steel having a thickness of at least 3 mm for ducts with a free cross-sectional

- area of less than  $0.075 \text{ m}^2$ , at least 4 mm for ducts with a free cross-sectional area of between  $0.075 \text{ m}^2$  and  $0.45 \text{ m}^2$ , and at least 5 mm for ducts with a free cross-sectional area of over  $0.45 \text{ m}^2$ ;
- (2) suitably supported and stiffened;
  - (3) fitted with automatic fire dampers close to the boundaries penetrated; and
  - (4) insulated to "A-60" class standard from the boundaries of the spaces they serve to a point at least 5 m beyond each fire damper;
- or
- (5) constructed of steel in accordance with (1) and (2); and
  - (6) insulated to "A-60" class standard throughout the spaces they pass through, except for ducts that pass through spaces of category ⑨ or ⑩ as defined in **102.3(2)(B)**.
5. For the purposes of **4(4)** and **4(6)** ducts shall be insulated over their entire cross-sectional external surface. Ducts that are outside but adjacent to the specified space, and share one or more surfaces with it, shall be considered to pass through the specified space, and shall be insulated over the surface they share with the space for a distance of 450 mm past the duct.
  6. Where it is necessary that a ventilation duct passes through a main vertical zone division, an automatic fire damper shall be fitted adjacent to the division. The damper shall also be capable of being manually closed from each side of the division. The control location shall be readily accessible and be clearly and prominently marked. The duct between the division and the damper shall be constructed of steel in accordance with **4(1)** and **4(2)** and insulated to at least the same fire integrity as the division penetrated. The damper shall be fitted on at least one side of the division with a visible indicator showing the operating position of the damper.

### 603. Details of fire dampers and duct penetrations

1. Ducts passing through "A" class divisions shall meet the following requirements:
  - (1) where a thin plated duct with a free cross sectional area equal to, or less than,  $0.02 \text{ m}^2$  passes through "A" class divisions, the opening shall be fitted with a steel sheet sleeve having a thickness of at least 3 mm and a length of at least 200 mm, divided preferably into 100 mm on each side of a bulkhead or, in the case of a deck, wholly laid on the lower side of the decks penetrated;
  - (2) where ventilation ducts with a free cross-sectional area exceeding  $0.02 \text{ m}^2$ , but not more than  $0.075 \text{ m}^2$ , pass through "A" class divisions, the openings shall be lined with steel sheet sleeves. The ducts and sleeves shall have a thickness of at least 3 mm and a length of at least 900 mm. When passing through bulkheads, this length shall be divided preferably into 450 mm on each side of the bulkhead. These ducts, or sleeves lining such ducts, shall be provided with fire insulation. The insulation shall have at least the same fire integrity as the division through which the duct passes; and
  - (3) automatic fire dampers shall be fitted in all ducts with a free cross-sectional area exceeding  $0.075 \text{ m}^2$  that pass through "A" class divisions. Each damper shall be fitted close to the division penetrated and the duct between the damper and the division penetrated shall be constructed of steel in accordance with **602.4(1)** and (2). The fire damper shall operate automatically, but shall also be capable of being closed manually from both sides of the division. The damper shall be fitted with a visible indicator which shows the operating position of the damper. Fire dampers are not required, however, where ducts pass through spaces surrounded by "A" class divisions, without serving those spaces, provided those ducts have the same fire integrity as the divisions which they penetrate. A duct of cross-sectional area exceeding  $0.075 \text{ m}^2$  shall not be divided into smaller ducts at the penetration of an "A" class division and then recombined into the original duct once through the division to avoid installing the damper required by this provision.
2. Ventilation ducts with a free cross-sectional area exceeding  $0.02 \text{ m}^2$  passing through "B" class bulkheads shall be lined with steel sheet sleeves of 900 mm in length, divided preferably into 450 mm on each side of the bulkheads unless the duct is of steel for this length.
3. All fire dampers shall be capable of manual operation. The dampers shall have a direct mechanical means of release or, alternatively, be closed by electrical, hydraulic, or pneumatic operation. All dampers shall be manually operable from both sides of the division. Automatic fire dampers, including those capable of remote operation, shall have a failsafe mechanism that will close the damper in a fire even upon loss of electrical power or hydraulic or pneumatic pressure loss. Remotely operated

fire dampers shall be capable of being reopened manually at the damper.

#### **604. Ventilation systems for passenger ships carrying more than 36 passengers**

1. In addition to the requirements in **601**, **602** and **603**, the ventilation system of a passenger ship carrying more than 36 passengers shall also meet the following requirements.
2. In general, the ventilation fans shall be so arranged that the ducts reaching the various spaces remain within a main vertical zone.
3. Stairway enclosures shall be served by an independent ventilation fan and duct system (exhaust and supply) which shall not serve any other spaces in the ventilation systems.
4. A duct, irrespective of its cross-section, serving more than one 'tween-deck accommodation space, service space or control station, shall be fitted, near the penetration of each deck of such spaces, with an automatic smoke damper that shall also be capable of being closed manually from the protected deck above the damper. Where a fan serves more than one 'tween-deck space through separate ducts within a main vertical zone, each dedicated to a single 'tween-deck space, each duct shall be provided with a manually operated smoke damper fitted close to the fan.
5. Vertical ducts shall, if necessary, be insulated as required by **Tables 8.7.1** and **8.7.2**. Ducts shall be insulated as required for decks between the space they serve and the space being considered, as applicable.

#### **605. Exhaust ducts from galley ranges**

##### **1. Requirements for passenger ships carrying more than 36 passengers**

In addition to the requirements in **601**., **602**., and **603**., exhaust ducts from galley ranges shall be constructed in accordance with paragraphs **602. 4** (5) and (6) and insulated to "A-60" class standard throughout accommodation spaces, service spaces, or control stations they pass through. They shall also be fitted with:

- (1) a grease trap readily removable for cleaning unless an alternative approved grease removal system is fitted;
  - (2) a fire damper located in the lower end of the duct at the junction between the duct and the galley range hood which is automatically and remotely operated and, in addition, a remotely operated fire damper located in the upper end of the duct close to the outlet of the duct;
  - (3) a fixed means for extinguishing a fire within the duct;
  - (4) remote-control arrangements for shutting off the exhaust fans and supply fans, for operating the fire dampers mentioned in (2) and for operating the fire-extinguishing system, which shall be placed in a position outside the galley close to the entrance to the galley. Where a multi-branch system is installed, a remote means located with the above controls shall be provided to close all branches exhausting through the same main duct before an extinguishing medium is released into the system; and
  - (5) suitably located hatches for inspection and cleaning, including one provided close to the exhaust fan and one fitted in the lower end where grease accumulates.
2. Exhaust ducts from ranges for cooking equipment installed on open decks shall conform to **1**, as applicable, when passing through accommodation spaces or spaces containing combustible materials.

##### **3. Requirements for cargo ships and passenger ships carrying not more than 36 passengers**

When passing through accommodation spaces or spaces containing combustible materials, the exhaust ducts from galley ranges shall be constructed in accordance with **602. 4** (1) and (2). Each exhaust duct shall be fitted with:

- (1) a grease trap readily removable for cleaning;
- (2) an automatically and remotely operated fire damper located in the lower end of the duct at the junction between the duct and the galley range hood and, in addition, a remotely operated fire damper in the upper end of the duct close to the outlet of the duct;
- (3) arrangements, operable from within the galley, for shutting off the exhaust and supply fans; and
- (4) fixed means for extinguishing a fire within the duct.

**606. Ventilation rooms serving machinery spaces of category A containing internal combustion machinery**

1. Where a ventilation room serves only such an adjacent machinery space and there is no fire division between the ventilation room and the machinery space, the means for closing the ventilation duct or ducts serving the machinery space shall be located outside of the ventilation room and machinery space.
2. Where a ventilation room serves such a machinery space as well as other spaces and is separated from the machinery space by a "A-0" class division, including penetrations, the means for closing the ventilation duct or ducts for the machinery space can be located in the ventilation room.

**607. Ventilation systems for laundries in passenger ships carrying more than 36 passengers**

Exhaust ducts from laundries and drying rooms of category ⑬ spaces as defined in **102. 3 (2)** shall be fitted with:

1. filters readily removable for cleaning purposes;
2. a fire damper located in the lower end of the duct which is automatically and remotely operated;
3. remote-control arrangements for shutting off the exhaust fans and supply fans from within the space and for operating the fire damper mentioned in paragraph **2**; and
4. suitably located hatches for inspection and cleaning. ⚴

## CHAPTER 8 FIRE FIGHTING

### Section 1 Water Supply System

#### 101. Water supply system

##### 1. General

Materials readily rendered ineffective by heat shall not be used for fire mains and hydrants unless adequately protected. The pipes and hydrants shall be so placed that the fire hoses may be easily coupled to them. The arrangement of pipes and hydrants shall be such as to avoid the possibility of freezing. Suitable drainage provisions shall be provided for fire main piping. Isolation valves shall be installed for all open deck fire main branches used for purposes other than fire fighting. In ships where deck cargo may be carried, the positions of the hydrants shall be such that they are always readily accessible and the pipes shall be arranged as far as practicable to avoid risk of damage by such cargo.

##### 2. Ready availability of water supply

###### (1) In passenger ships

- (A) in case of 1,000 gross tonnage and upwards such that at least one effective jet of water is immediately available from any hydrant in an interior location and so as to ensure the continuation of the output of water by the automatic starting of one required fire pump;
- (B) in case of less than 1,000 gross tonnage by automatic start of at least one fire pump or by remote starting from the navigation bridge of at least one fire pump. If the pump starts automatically or if the bottom valve cannot be opened from where the pump is remotely started, the bottom valve shall always be kept open; and
- (C) if fitted with periodically unattended machinery spaces, the Society shall determine provisions for fixed water fire-extinguishing arrangement for such spaces equivalent to those required for normally attended machinery spaces;

###### (2) In Cargo ships

With a periodically unattended machinery space or when only one person is required on watch, there shall be immediate water delivery from the fire main system at a suitable pressure, either by remote starting of one of the main fire pumps with remote starting from the navigating bridge and fire control station, if any, or permanent pressurization of the fire main system by one of the main fire pumps, except that the Society may waive this requirement for cargo ships of less than 1,600 gross tonnage if the fire pump starting arrangement in the machinery space is in an easily accessible position.

##### 3. Diameter of the fire main

The diameter of the fire main and water service pipes shall be sufficient for the effective distribution of the maximum required discharge from two fire pumps operating simultaneously, except that in the case of cargo ships, other than those included in **603. 2** the diameter need only be sufficient for the discharge of 140 m<sup>3</sup>/h.

##### 4. Isolating valves and relief valves

- (1) Isolating valves to separate the section of the fire main within the machinery space containing the main fire pump or pumps from the rest of the fire main shall be fitted in an easily accessible and tenable position outside the machinery spaces. The fire main shall be so arranged that when the isolating valves are shut all the hydrants on the ship, except those in the machinery space referred to above, can be supplied with water by another fire pump or an emergency fire pump. The emergency fire pump, its seawater inlet, and suction and delivery pipes and isolating valves shall be located outside the machinery space. If this arrangement cannot be made, the sea-chest may be fitted in the machinery space if the sea inlet valve is remotely controlled from a position in the same compartment as the emergency pump and the suction pipe is as short as practicable. Short lengths of suction or discharge piping may penetrate the machinery space, provided they are enclosed in a substantial steel casing, or are insulated to A-60 class standards. The pipes shall have substantial wall thickness, but in no case less than 11 mm, and shall be welded except for the flanged connection to the sea inlet valve. **[See Guidance]**

- (2) A valve shall be fitted to serve each fire hydrant so that any fire hose may be removed while the fire pumps are in operation.
- (3) Relief valves shall be provided in conjunction with fire pumps if the pumps are capable of developing a pressure exceeding the design pressure of the water service pipes, hydrants and hoses. These valves shall be so placed and adjusted as to prevent excessive pressure in any part of the fire main system.
- (4) In tankers, isolation valves shall be fitted in the fire main at poop front in a protected position and on the tank deck at intervals of not more than 40 m to preserve the integrity of the fire main system in case of fire or explosion. **【See Guidance】**

#### 5. Number and position of hydrants

- (1) The number and position of hydrants shall be such that at least two jets of water not emanating from the same hydrant, one of which shall be from a single length of hose, may reach any part of the ship normally accessible to the passengers or crew while the ship is being navigated and any part of any cargo space when empty, any ro-ro space or any vehicle space in which latter case the two jets shall reach any part of the space, each from a single length of hose. Furthermore, such hydrants shall be positioned near the accesses to the protected spaces.
- (2) In addition to the requirements in the paragraph (1), passenger ships shall comply with the following:
  - (A) in the accommodation, service and machinery spaces the number and position of hydrants shall be such that the requirements of paragraph (1) may be complied with when all watertight doors and all doors in main vertical zone bulkheads are closed; and
  - (B) where access is provided to a machinery space of category A at a low level from an adjacent shaft tunnel, two hydrants shall be provided external to, but near the entrance to that machinery space. Where such access is provided from other spaces, in one of those spaces two hydrants shall be provided near the entrance to the machinery space of category A. Such provision need not be made where the tunnel or adjacent spaces are not part of the escape route.

#### 6. Pressure at hydrants

With the two pumps simultaneously delivering water through the nozzles specified in **103. 3**, with the quantity of water as specified in **Par 3**, through any adjacent hydrants, the following minimum pressures shall be maintained at all hydrants: **【See Guidance】**

- (1) for passenger ships:

4,000 gross tonnage and upwards	0.40 MPa
less than 4000 gross tonnage	0.30 MPa
- (2) for cargo ships,

6,000 gross tonnage and upwards	0.27 MPa
less than 6,000 gross tonnage;	0.25 MPa
- (3) the maximum pressure at any hydrant shall not exceed that at which the effective control of a fire hose can be demonstrated.

#### 7. International shore connection **【See Guidance】**

- (1) Ships of 500 gross tonnage and upwards shall be provided with at least one international shore connection complying with the FSS Code.
- (2) Facilities shall be available enabling such a connection to be used on either side of the ship.

### 102. Fire pump

#### 1. Pumps accepted as fire pumps

Sanitary, ballast, bilge or general service pumps may be accepted as fire pumps, provided that they are not normally used for pumping oil and that if they are subject to occasional duty for the transfer or pumping of oil fuel, suitable change-over arrangements are fitted.

#### 2. Number of fire pumps

Ships shall be provided with independently driven fire pumps as follows:

- (1) in passenger ships of:
  - (A) 4,000 gross tonnage and upwards at least three



- (B) less than 4,000 gross tonnage at least two
- (2) in cargo ships of:
  - (A) 1,000 gross tonnage and upwards at least two
  - (B) less than 1,000 gross tonnage at least two power driven pumps, one of which shall be independently driven.

### 3. Arrangement of fire pumps and fire main **【See Guidance】**

- (1) Fire pumps  
The arrangement of sea connections, fire pumps and their sources of power shall be as to ensure that:
  - (A) in passenger ships of 1,000 gross tonnage and upwards, in the event of a fire in any one compartment all the fire pumps will not be put out of action; and
  - (B) in passenger ships of less than 1,000 gross tonnage and in cargo ships, if a fire in any one compartment could put all the pumps out of action, there shall be an alternative means consisting of an emergency fire pump complying with the provisions of the FSS Code with its source of power and sea connection located outside the space where the main fire pumps or their sources of power are located.
- (2) Requirements for the space containing the emergency fire pump
  - (A) Location of the space  
The space containing the fire pump shall not be contiguous to the boundaries of machinery spaces of category A or those spaces containing main fire pumps. Where this is not practicable, the common bulkhead between the two spaces shall be insulated to a standard of structural fire protection equivalent to that required for a control station in **Ch 7, 103. 3**.
  - (B) Access to the emergency fire pump  
No direct access shall be permitted between the machinery space and the space containing the emergency fire pump and its source of power. When this is impracticable, the Society may accept an arrangement where the access is by means of an airlock with the door of the machinery space being of A-60 class standard, and the other door being at least steel, both reasonably gastight, self-closing and without any hold back arrangements. Alternatively, the access may be through a watertight door capable of being operated from a space remote from the machinery space and the space containing the emergency fire pump and unlikely to be cut off in the event of fire in those spaces. In such cases, a second means of access to the space containing the emergency fire pump and its source of power shall be provided.
  - (C) Ventilation of the emergency fire pump space  
Ventilation arrangements to the space containing the independent source of power for the emergency fire pump shall be such as to preclude, as far as practicable, the possibility of smoke from a machinery space fire entering or being drawn into that space.
- (3) Additional pumps for cargo ships  
In addition, in cargo ships where other pumps, such as general service, bilge and ballast, etc., are fitted in a machinery space, arrangements shall be made to ensure that at least one of these pumps, having the capacity and pressure required by **101. 6(2)** and **102. 4(2)** is capable of providing water to the fire main.

### 4. Capacity of fire pumps **【See Guidance】**

- (1) Total capacity of required fire pumps  
The required fire pumps shall be capable of delivering for fire-fighting purposes a quantity of water, at the pressure specified in **101. 6**, as follows:
  - (A) pumps in passenger ships, the quantity of water is not less than two thirds of the quantity required to be dealt with by the bilge pumps when employed for bilge pumping; and
  - (B) pumps in cargo ships, other than any emergency pump, the quantity of water is not less than four thirds of the required quantity to be dealt with by each of the independent bilge pumps in a passenger ship of the same dimension when employed in bilge pumping, provided that in no cargo ship, need the total required capacity of the fire pumps exceed 180 m<sup>3</sup>/h.
- (2) Capacity of each fire pump  
Each of the required fire pumps (other than any emergency pump required in **102. 3(1)(B)** for cargo ships) shall have a capacity not less than 80 % of the total required capacity divided by the minimum number of required fire pumps but in any case not less than 25 m<sup>3</sup>/h and each such pump shall in any event be capable of delivering at least the two required jets of water.

These fire pumps shall be capable of supplying the fire main system under the required conditions. Where more pumps than the minimum of required pumps are installed such additional pumps shall have a capacity of at least 25 m<sup>3</sup>/h and shall be capable of delivering at least the two jets of water required in **101. 5 (1)**.

### 103. Fire hoses and nozzles [See Guidance]

#### 1. General specifications

Fire hoses shall be of non-perishable material approved and shall be sufficient in length to project a jet of water to any of the spaces in which they may be required to be used. Each hose shall be provided with a nozzle and the necessary couplings. Hoses specified in this chapter as "fire hoses" shall, together with any necessary fittings and tools, be kept ready for use in conspicuous positions near the water service hydrants or connections. Additionally, in interior locations in passenger ships carrying more than 36 passengers fire hoses shall be connected to the hydrants at all times. Fire hoses shall have a length of at least 10 m, but not more than:

- (1) 15 m in machinery spaces;
- (2) 20 m in other spaces and open decks; and
- (3) 25 m for open decks on ships with a maximum breadth in excess of 30 m.

Unless one hose and nozzle is provided for each hydrant in the ship, there shall be complete interchangeability of hose couplings and nozzles.

#### 2. Number and diameter of fire hoses

- (1) Ships shall be provided with fire hoses the number and diameter of which shall be to the satisfaction of the Society.
- (2) In passenger ships, there shall be at least one fire hose for each of the hydrants required by **101. 5** and these hoses shall be used only for the purposes of extinguishing fires or testing the fire-extinguishing apparatus at fire drills and surveys.
- (3) In cargo ships
  - (A) of 1,000 gross tonnage and upwards, the number of fire hoses to be provided shall be one for each 30 m length of the ship and one spare but in no case less than five in all. This number does not include any hoses required in any engine or boiler room. The Society may increase the number of hoses required so as to ensure that hoses in sufficient number are available and accessible at all times, having regard to the type of ship and the nature of trade in which the ship is employed. Ships carrying dangerous goods in accordance with the Rules for Classification of Steel Ships, **Ch. 12** shall be provided with 3 hoses and nozzles, in addition to those required above;
  - (B) of less than 1,000 gross tonnage, the number of fire hoses to be provided shall be calculated in accordance with this paragraph. However, the number of hoses shall in no case be less than three.

#### 3. Size and types of nozzles

- (1) For the purposes of this chapter, standard nozzle sizes shall be 12 mm, 16 mm and 19 mm or as near thereto as possible. Larger diameter nozzles may be permitted at the discretion of the Society.
- (2) For accommodation and service spaces, a nozzle size greater than 12 mm need not be used.
- (3) For machinery spaces and exterior locations, the nozzle size shall be such as to obtain the maximum discharge possible from two jets at the pressure mentioned in **101. 6** from the smallest pump, provided that a nozzle size greater than 19 mm need not be used.
- (4) Nozzles shall be of an approved dual-purpose type (i.e., spray/jet type) incorporating a shutoff.

## Section 2 Portable Fire Extinguisher

### 201. Type and design [See Guidance]

Portable fire extinguishers shall comply with the requirements of the FSS Code.

### 202. Arrangement of fire extinguishers [See Guidance]

1. Accommodation spaces, service spaces and control stations shall be provided with portable fire extinguishers of appropriate types and in sufficient number to the satisfaction of the Society. Ships of 1,000 gross tonnage and upwards shall carry at least five portable fire extinguishers.
2. One of the portable fire extinguishers intended for use in any space shall be stowed near the entrance to that space.
3. Carbon dioxide fire extinguishers shall not be placed in accommodation spaces. In control stations and other spaces containing electrical or electronic equipment or appliances necessary for the safety of the ship, fire extinguishers should be provided whose extinguishing media are neither electrically conductive nor harmful to the equipment and appliances.
4. Fire extinguishers shall be situated ready for use at easily visible places, which can be reached quickly and easily at any time in the event of a fire, and in such a way that their serviceability is not impaired by the weather, vibration or other external factors. Portable fire extinguishers shall be provided with devices which indicate whether they have been used.

### 203. Spare charges

1. Spare charges shall be provided for 100 % of the first 10 extinguishers and 50 % of the remaining fire extinguishers capable of being recharged on board. Not more than 60 total spare charges are required. Instructions for recharging shall be carried on board.
2. For fire extinguishers which cannot be recharged onboard, additional portable fire extinguishers of the same quantity, type, capacity and number as determined in **1** above shall be provided in lieu of spare charges.

## Section 3 Fixed Fire-extinguishing Systems

### 301. Types of fixed fire extinguishing systems

1. A fixed fire extinguishing system required by **Sec. 4** below may be any of the following systems: [See Guidance]
  - (1) a fixed gas fire-extinguishing system complying with the provisions of the FSS Code;
  - (2) a fixed high-expansion foam fire-extinguishing system complying with the provisions of the FSS Code; and
  - (3) a fixed pressure water-spraying fire-extinguishing system complying with the provisions of the FSS Code.
2. Where a fixed fire-extinguishing system not required by this chapter is installed, it shall meet the requirements of the relevant regulations of this chapter and the FSS Code.
3. Fire-extinguishing systems using Halon 1211, 1301, 2402 and perfluorocarbons shall be prohibited.
4. In general, the Society shall not permit the use of steam as a fire-extinguishing medium in fixed fire-extinguishing systems. Where the use of steam is permitted, it shall be used only in restricted areas as an addition to the required fire-extinguishing system and shall comply with the requirements of the FSS Code.

### 302. Closing appliances for fixed gas fire-extinguishing systems

Where a fixed gas fire-extinguishing system is used, openings which may admit air to, or allow gas to

escape from, a protected space shall be capable of being closed from outside the protected space.

### 303. Storage rooms of fire extinguishing medium [See Guidance]

When the fire extinguishing medium is stored outside a protected space, it shall be stored in a room which is located behind the forward collision bulkhead, and is used for no other purposes. Any entrance to such a storage room shall preferably be from the open deck and shall be independent of the protected space. If the storage space is located below deck, it shall be located no more than one deck below the open deck and shall be directly accessible by a stairway or ladder from the open deck. Spaces which are located below deck or spaces where access from the open deck is not provided, shall be fitted with a mechanical ventilation system designed to take exhaust air from the bottom of the space and shall be sized to provide at least 6 air changes per hour. Access doors shall open outwards, and bulkheads and decks including doors and other means of closing any opening therein, which form the boundaries between such rooms and adjacent enclosed spaces shall be gastight. For the purpose of the application of **Tables 8.7.1 to 8.7.8**, such storage rooms shall be treated as fire control stations.

### 304. Water pumps for other fire-extinguishing systems

Pumps, other than those serving the fire main, required for the provision of water for fire-extinguishing systems required by this chapter, their sources of power and their controls shall be installed outside the space or spaces protected by such systems and shall be so arranged that a fire in the space or spaces protected will not put any such system.

## Section 4 Fire Extinguishing Arrangements In Machinery Spaces

### 401. Machinery spaces containing oil-fired boilers or oil fuel units [See Guidance]

#### 1. Fixed fire-extinguishing systems

Machinery spaces of category A containing oil-fired boilers or oil fuel units shall be provided with any one of the fixed fire-extinguishing systems in **301**.. In each case, if the engine and boiler rooms are not entirely separate, or if fuel oil can drain from the boiler room into the engine-room, the combined engine and boiler rooms shall be considered as one compartment.

#### 2. Additional fire-extinguishing arrangements

- (1) There shall be in each boiler room or at an entrance outside of the boiler room at least one portable foam applicator unit complying with the provisions of the FSS Code.
- (2) There shall be at least two portable foam extinguishers or equivalent in each firing space in each boiler room and in each space in which a part of the oil fuel installation is situated. There shall be not less than one approved foam-type extinguisher of at least 135 liters capacity or equivalent in each boiler room. These extinguishers shall be provided with hoses on reels suitable for reaching any part of the boiler room. In the case of domestic boilers of less than 175 kW or boilers protected by fixed water-based local application fire-extinguishing systems as required by **406**., an approved foam-type extinguisher of at least 135 liters capacity is not required. (2020)
- (3) In each firing space there shall be a receptacle containing at least 0.1 m<sup>3</sup> sand, sawdust impregnated with soda, or other approved dry material, along with a suitable shovel for spreading the material. An approved portable extinguisher may be substituted as an alternative.

### 402. Machinery spaces of category A containing internal combustion machinery [See Guidance]

#### 1. Fixed fire-extinguishing systems

Machinery spaces of category A containing internal combustion machinery shall be provided with one of the fixed fire-extinguishing systems in **301**..

#### 2. Additional fire-extinguishing arrangements

- (1) There shall be at least one portable foam applicator unit complying with the provisions of the FSS Code.
- (2) There shall be in each such space approved foam-type fire extinguishers, each of at least 45 L capacity or equivalent, sufficient in number to enable foam or its equivalent to be directed on to any part of the fuel and lubricating oil pressure systems, gearing and other fire hazards. In addition, there shall be provided a sufficient number of portable foam extinguishers or equivalent which shall be so located that no point in the space is more than 10 m walking distance from an extinguisher and that there are at least two such extinguishers in each such space. For smaller spaces of cargo ships the Society may consider relaxing this requirement.

#### 403. Machinery spaces containing steam turbines or enclosed steam engines

##### 1. Fixed fire-extinguishing systems

In spaces containing steam turbines or enclosed steam engines used for main propulsion or other purposes having in the aggregate a total output of not less than 375 kW, one of the fire-extinguishing systems specified in **301**, shall be provided if such spaces are periodically unattended.

##### 2. Additional fire-extinguishing arrangements

- (1) There shall be approved foam fire extinguishers each of at least 45 L capacity or equivalent sufficient in number to enable foam or its equivalent to be directed on to any part of the pressure lubrication system, on to any part of the casings enclosing pressure lubricated parts of the turbines, engines or associated gearing, and any other fire hazards. However, such extinguishers shall not be required if protection, at least equivalent to that required by this subparagraph, is provided in such spaces by a fixed fire-extinguishing system fitted in compliance with **301**.
- (2) There shall be a sufficient number of portable foam extinguishers or equivalent which shall be so located that no point in the space is more than 10 m walking distance from an extinguisher and that there are at least two such extinguishers in each such space, except that such extinguishers shall not be required in addition to any provided in compliance with **401.2 (2)**.

#### 404. Other machinery spaces

Where, in the opinion of the Society, a fire hazard exists in any machinery space for which no specific provisions for fire-extinguishing appliances are prescribed in **401**, **402**, and **403**, there shall be provided in, or adjacent to, that space such a number of approved portable fire extinguishers or other means of fire extinction as the Society may deem sufficient.

#### 405. Additional requirements for passenger ships **【See Guidance】**

In passenger ships carrying more than 36 passengers, each machinery space of category A shall be provided with at least two suitable water fog applicators.

#### 406. Fixed local application fire-fighting systems **【See Guidance】**

1. It shall apply to passenger ships of 500 gross tonnage and above and cargo ships of 2000 gross tonnage and above.
2. Machinery spaces of category A above 500 m<sup>3</sup> in volume shall, in addition to the fixed fire-extinguishing system required in **401.1**, be protected by an approved type of fixed water-based or equivalent local application fire-fighting system, based on the guidelines developed by the IMO Organization. In the case of periodically unattended machinery spaces, the fire fighting system shall have both automatic and manual release capabilities. In the case of continuously manned machinery spaces, the fire-fighting system is only required to have a manual release capability.
3. Fixed local application fire-fighting systems are to protect areas such as the following without the necessity of engine shutdown, personnel evacuation, or sealing of the spaces:
  - (1) the fire hazard portions of internal combustion machinery;
  - (2) boiler fronts;
  - (3) the fire hazard portions of incinerators; and
  - (4) purifiers for heated fuel oil.
4. Activation of any local application system shall give a visual and distinct audible alarm in the pro-

tected space and at continuously manned stations. The alarm shall indicate the specific system activated. The system alarm requirements described within this paragraph are in addition to, and not a substitute for, the detection and fire alarm system required elsewhere in this chapter.

## Section 5 Fire-extinguishing Arrangements In Control Stations, Accommodation and Service Spaces

### 501. Sprinkler and water spray systems in passenger ships

1. Passenger ships carrying more than 36 passengers shall be equipped with an automatic sprinkler, fire detection and fire alarm system of an approved type complying with the requirements of the FSS Code in all control stations, accommodation and service spaces, including corridors and stairways. Alternatively, control stations, where water may cause damage to essential equipment, may be fitted with an approved fixed fire-extinguishing system of another type. Spaces having little or no fire risk such as voids, public toilets, carbon dioxide rooms and similar spaces need not be fitted with an automatic sprinkler system. **[See Guidance]**
2. In passenger ships carrying not more than 36 passengers, when a fixed smoke detection and fire alarm system complying with the provisions of the FSS Code is provided only in corridors, stairways and escape routes within accommodation spaces, an automatic sprinkler system shall be installed in accordance with regulation **Ch 5 303. 2**.
3. A fixed pressure water-spraying fire-extinguishing system complying with the provisions of the FSS Code shall be installed on cabin balconies of ships to which regulation **Ch 3, 204** applies, where furniture and furnishings on such balconies are not as defined in regulations **Ch 1, 103. 40** (1), (2), (3), (6) and (7).

### 502. Sprinkler systems for cargo ships

In cargo ships in which method IIC specified in regulation **Ch 7, 103. 1** (1) (B) is adopted, an automatic sprinkler, fire detection and fire alarm system shall be fitted in accordance with the requirements in regulation **Ch 5, 305. 2**.

### 503. Spaces containing flammable liquid

1. Paint lockers shall be protected by:
  - (1) a carbon dioxide system, designed to give a minimum volume of free gas equal to 40 % of the gross volume of the protected space.
  - (2) a dry powder system, designed for at least  $0.5 \text{ kg/m}^3$  ;
  - (3) a water spraying or sprinkler system, designed for  $5 \text{ L/m}^2 \cdot \text{min}$ . Water spraying systems may be connected to the fire main of the ship; or
  - (4) a system providing equivalent protection, as determined by the Society. In any case, the system shall be operable from outside the protected space.
2. Flammable liquid lockers shall be protected by an appropriate fire-extinguishing arrangement approved by the Society. **[See Guidance]**
3. For lockers of a deck area of less than  $4 \text{ m}^2$ , which do not give access to accommodation spaces, a carbon dioxide portable fire extinguisher sized to provide a minimum volume of free gas equal to 40 % of the gross volume of the space may be accepted in lieu of a fixed system. A discharge port shall be arranged in the locker to allow the discharge of the extinguisher without having to enter into the protected space. The required portable fire extinguisher shall be stowed adjacent to the port. Alternatively, a port or hose connection may be provided to facilitate the use of fire main water. **[See Guidance]**

### 504. Deep-fat cooking equipment **[See Guidance]**

Deep-fat cooking equipment installed in enclosed spaces or on open decks shall be fitted with the following:

1. An automatic or manual extinguishing system tested to an international standard acceptable to the IMO;
2. A primary and backup thermostat with an alarm to alert the operator in the event of failure of either thermostat;
3. Arrangements for automatically shutting off the electrical power upon activation of the extinguishing system;
4. An alarm for indicating operation of the extinguishing system in the galley where the equipment is installed; and
5. Controls for manual operation of the extinguishing system which are clearly labelled for ready use by the crew.

## Section 6 Fire-extinguishing Arrangements In Cargo Spaces

### 601. Fixed gas fire-extinguishing systems for general cargo [See Guidance]

1. Except as provided for in **602.**, the cargo spaces of passenger ships of 1,000 gross tonnage and upwards shall be protected by a fixed carbon dioxide or inert gas fire-extinguishing system complying with the provisions of the FSS Code or by a fixed high expansion foam fire-extinguishing system which gives equivalent protection.
2. Where it is shown to the satisfaction of the Society that a passenger ship is engaged on voyages of such short duration that it would be unreasonable to apply the requirements of **1** and also in ships of less than 1,000 gross tonnage, the arrangements in cargo spaces shall be to the satisfaction of the Society, provided that the ship is fitted with steel hatch covers and effective means of closing all ventilators and other openings leading to the cargo spaces.
3. Except for ro-ro and vehicle spaces, cargo spaces on cargo ships of 2,000 gross tonnage and upwards shall be protected by a fixed carbon dioxide or inert gas fire-extinguishing system complying with the provisions of the FSS Code, or by a fire-extinguishing system which gives equivalent protection.
4. The Society may exempt from the requirements of **3** and **602.**, cargo spaces of any cargo ship if constructed, and solely intended for, the carriage of ore, coal, grain, unseasoned timber, non-combustible cargoes or cargoes which, in the opinion of the Society, constitute a low fire risk. Such exemptions may be granted only if the ship is fitted with steel hatch covers and effective means of closing ventilators and other openings leading to the cargo spaces. The Society shall issue an exemption certificate concerned and shall ensure that the list of cargoes the ship is permitted to carry is attached to the exemption certificate.

### 602. Fixed gas fire-extinguishing systems for dangerous goods [See Guidance]

A ship engaged in the carriage of dangerous goods in any cargo spaces shall be provided with a fixed carbon dioxide or inert gas fire-extinguishing system complying with the provisions of the FSS Code or with a fire-extinguishing system which, in the opinion of the Society, gives equivalent protection for the cargoes carried.

### 603. Firefighting for ships designed to carry containers on or above the weather deck

1. Ships shall carry, in addition to the equipment and arrangements required by **601.** and **602.**, at least one water mist lance. The water mist lance shall consist of a tube with a piercing nozzle which is capable of penetrating a container wall and producing water mist inside a confined space (container, etc.) when connected to the fire main.
2. Ships designed to carry five or more tiers of containers on or above the weather deck shall carry, in addition to the requirements of **1**, mobile water monitors\* as follows: [See Guidance]
  - ships with breadth less than 30 m: at least two mobile water monitors; or
  - ships with breadth of 30 m or more: at least four mobile water monitors.

- (1) The mobile water monitors, all necessary hoses, fittings and required fixing hardware shall be kept ready for use in a location outside the cargo space area not likely to be cut-off in the event of a fire in the cargo spaces.
- (2) A sufficient number of fire hydrants shall be provided such that:
  - (A) all provided mobile water monitors can be operated simultaneously for creating effective water barriers forward and aft of each container bay;
  - (B) the two jets of water required by **101. 6** can be supplied at the pressure required by **101. 5** (1); and
  - (C) each of the required mobile water monitors can be supplied by separate hydrants at the pressure necessary to reach the top tier of containers on deck.
- (3) The mobile water monitors may be supplied by the fire main, provided the capacity of fire pumps and fire main diameter are adequate to simultaneously operate the mobile water monitors and two jets of water from fire hoses at the required pressure values. If carrying dangerous goods, the capacity of fire pumps and fire main diameter shall also comply with **Ch 12**, as far as applicable to on-deck cargo areas.
- (4) The operational performance of each mobile water monitor shall be tested during initial survey on board the ship to the satisfaction of the Administration. The test shall verify that:
  - (A) the mobile water monitor can be securely fixed to the ship structure ensuring safe and effective operation; and
  - (B) the mobile water monitor jet reaches the top tier of containers with all required monitors and water jets from fire hoses operated simultaneously.

## Section 7 Cargo Tank Protection

### 701. Fixed deck foam systems [See Guidance]

1. For tankers of 20,000 tonnes deadweight and upwards, a fixed deck foam system shall be provided in accordance with the requirements of the FSS Code, except that, in lieu of the above, the Society, after having given consideration to the ship's arrangement and equipment, may accept other fixed installations if they afford protection equivalent to the above. The requirements for alternative fixed installations shall comply with the requirements in **2**.
2. In accordance with **1**, where the Society accepts an equivalent fixed installation in lieu of the fixed deck foam system, the installation shall:
  - (1) be capable of extinguishing spill fires and also preclude ignition of spilled oil not yet ignited;
  - (2) be capable of combating fires in ruptured tanks.
3. Tankers of less than 20,000 tonnes deadweight shall be provided with a deck foam system complying with the requirements of the FSS Code.

## Section 8 Protection of Cargo Pump Room

### 801. Fixed fire-extinguishing systems [See Guidance]

Each cargo pump-room shall be provided with one of the following fixed fire-extinguishing systems operated from a readily accessible position outside the pump-room. Cargo pump-rooms shall be provided with a system suitable for machinery spaces of category A.

1. A carbon dioxide system complying with the provisions the FSS Code and with the following requirements :
  - (1) the alarms giving audible warning of the release of fire-extinguishing medium shall be safe for use in a flammable cargo vapour/air mixture; and
  - (2) a notice shall be exhibited at the controls stating that due to the electrostatic ignition hazard, the system is to be used only for fire extinguishing and not for inerting purposes.
2. A high-expansion foam system complying with the provisions of the FSS Code, provided that the foam concentrate supply is suitable for extinguishing fires involving the cargoes carried.



3. A fixed pressure water-spraying system complying with the provisions of the FSS Code.

### 802. Quantity of fire-extinguishing medium

Where the extinguishing medium used in the cargo pump-room system is also used in systems serving other spaces, the quantity of medium provided or its delivery rate need not be more than the maximum required for the largest compartment.

## Section 9 Fire-fighter's Outfit

### 901. Types of fire-fighter's outfits [See Guidance]

Fire-fighter's outfits shall comply with the FSS Code.

### 902. Number of fire-fighter's outfits

1. Ships shall carry at least two fire-fighter's outfits.
2. In addition, in passenger ships there shall be provided:
  - (1) for every 80 m, or part thereof, of the aggregate of the lengths of all passenger spaces and service spaces on the deck which carries such spaces or, if there is more than one such deck, on the deck which has the largest aggregate of such lengths, two fire-fighter's outfits and, in addition, two sets of personal equipment, each set comprising the items stipulated in the FSS Code. In passenger ships carrying more than 36 passengers, two additional fire-fighter's outfits shall be provided for each main vertical zone. However, for stairway enclosures which constitute individual main vertical zones and for the main vertical zones in the fore or aft end of a ship which do not contain spaces of categories ⑥, ⑦, ⑧, ⑫ defined in regulation **Ch 7, 102.3 (2)**, no additional fire-fighter's outfits are required; and
  - (2) ships carrying more than 36 passengers, for each pair of breathing apparatus there shall be provided one water fog applicator which shall be stored adjacent to such apparatus.
3. In addition, in tankers, two fire-fighter's outfits shall be provided.
4. The Society may require additional sets of personal equipment and breathing apparatus, having due regard to the size and type of the ship.
5. Two spare charges shall be provided for each required breathing apparatus. Passenger ships carrying not more than 36 passengers and cargo ships that are equipped with suitably located means for fully recharging the air cylinders free from contamination, need carry only one spare charge for each required apparatus. In passenger ships carrying more than 36 passengers, at least two spare charges for each breathing apparatus shall be provided.
6. Passenger ships carrying more than 36 passengers shall be fitted with a suitably located means for fully recharging breathing air cylinders, free from contamination. The means for recharging shall be either :
  - (1) breathing air compressors supplied from the main and emergency switchboard, or independently driven, with a minimum capacity of 60 l/min per required breathing apparatus, not to exceed 420 l/min; or
  - (2) self-contained high-pressure storage systems of suitable pressure to recharge the breathing apparatus used on board, with a capacity of at least 1,200 L per required breathing apparatus, not to exceed 50,000 L of free air.
7. An onboard means of recharging breathing apparatus cylinders used during drills shall be provided or a suitable number of spare cylinders shall be carried onboard to replace those used.

### 903. Storage of fire-fighter's outfits

1. The fire-fighter's outfits or sets of personal equipment shall be kept ready for use in an easily accessible location that is permanently and clearly marked and, where more than one fire-fighter's outfit or more than one set of personal equipment is carried, they shall be stored in widely separated positions.

2. In passenger ships, at least two fire-fighter's outfits and, in addition, one set of personal equipment shall be available at any one position. At least two fire-fighter's outfits shall be stored in each main vertical zone.

**904. Fire-fighter's communication** **【See Guidance】**

A minimum of two-way portable radiotelephone apparatus for each fire party for fire-fighter's communication shall be carried on board. Those two-way portable radiotelephone apparatus shall be of an explosion-proof type or intrinsically safe. ↓

## CHAPTER 9 STRUCTURAL INTEGRITY

### Section 1 Material

#### 101. Material of hull, superstructures, structural bulkheads, decks and deckhouses **【See Guidance】**

The hull, superstructures, structural bulkheads, decks and deckhouses shall be constructed of steel or other equivalent material. For the purpose of applying the definition of steel or other equivalent material as given in **Ch 1, 103. 43** the "applicable fire exposure" shall be according to the integrity and insulation standards given in **Tables 8.7.1 to 8.7.4**. For example, where divisions such as decks or sides and ends of deckhouses are permitted to have "B-0" fire integrity, the "applicable fire exposure shall be half an hour.

### Section 2 Structure of aluminium alloy

#### 201. Structure of aluminium alloy

Unless otherwise specified in **101.**, in cases where any part of the structure is of aluminium alloy, the following shall apply:

1. the insulation of aluminium alloy components of "A" or "B" class divisions, except structure which, in the opinion of the Society, is non-load-bearing, shall be such that the temperature of the structural core does not rise more than 200 °C above the ambient temperature at any time during the applicable fire exposure to the standard fire test; and **【See Guidance】**
2. special attention shall be given to the insulation of aluminium alloy components of columns, stanchions and other structural members required to support lifeboat and liferaft stowage, launching and embarkation areas, and "A" and "B" class divisions to ensure:
  - (1) that for such members supporting lifeboat and liferaft areas and "A" class divisions, the temperature rise limitation specified in **1** shall apply at the end of one hour; and
  - (2) that for such members required to support "B" class divisions, the temperature rise limitation specified in **1** shall apply at the end of half an hour.

### Section 3 Machinery Spaces of Category A

#### 301. Machinery spaces of category A

1. Crowns and casings of machinery spaces of category A shall be of steel construction and shall be insulated as required by **Tables 8.7.5 and 8.7.7**, as appropriate. **【See Guidance】**
2. The floor plating of normal passageways in machinery spaces of category A shall be made of steel.

### Section 4 Materials of Overboard Fittings

#### 401. Materials of overboard fittings **【See Guidance】**

Materials readily rendered ineffective by heat shall not be used for overboard scuppers, sanitary discharges, and other outlets which are close to the waterline and where the failure of the material in the event of fire would give rise to danger of flooding.

## Section 5 Protection of Cargo Tank Structure Against Pressure Or Vacuum In Tankers

### 501. General

The venting arrangements shall be so designed and operated as to ensure that neither pressure nor vacuum in cargo tanks shall exceed design parameters and be such as to provide for

1. the flow of the small volumes of vapour, air or inert gas mixtures caused by thermal variations in a cargo tank in all cases through pressure/vacuum valves; and **[See Guidance]**
2. the passage of large volumes of vapour, air or inert gas mixtures during cargo loading and ballasting, or during discharging.

### 502. Openings for small flow by thermal variations **[See Guidance]**

Openings for pressure release required by **501. 1** shall have as great a height as is practicable above the cargo tank deck to obtain maximum dispersal of flammable vapours, but in no case less than 2 m above the cargo tank deck; and be arranged at the furthest distance practicable but not less than 5 m from the nearest air intakes and openings to enclosed spaces containing a source of ignition and from deck machinery and equipment which may constitute an ignition hazard. Anchor windlass and chain locker openings constitute an ignition hazard. For tankers constructed on or after 1 January 2017, the openings shall be arranged in accordance with **Ch 2, 403. 4 (1)**.

### 503. Safety measures in cargo tanks

#### 1. Preventive measures against liquid rising in the venting system

Provisions shall be made to guard against liquid rising in the venting system to a height which would exceed the design head of cargo tanks. This shall be accomplished by high-level alarms or overflow control systems or other equivalent means, together with independent gauging devices and cargo tank filling procedures. For the purposes of this regulation, spill valves are not considered equivalent to an overflow system.

#### 2. Secondary means for pressure/vacuum relief **[See Guidance]**

A secondary means of allowing full flow relief of vapour, air or inert gas mixtures to prevent over-pressure or under-pressure in the event of failure of the arrangements in **501. 2**. In addition, for tankers, the secondary means shall be capable of preventing over-pressure or under-pressure in the event of damage to, or inadvertent closing of, the means of isolation required in **Ch 2, 403. 4 (1)**. Alternatively, pressure sensors may be fitted in each tank protected by the arrangement required in **501. 2**, with a monitoring system in the ship's cargo control room or the position from which cargo operations are normally carried out. Such monitoring equipment shall also provide an alarm facility which is activated by detection of over-pressure or under-pressure conditions within a tank. (2018)

#### 3. Bypasses in vent mains

Pressure/vacuum valves required by **501. 1** may be provided with a bypass arrangement when they are located in a vent main or masthead riser. Where such an arrangement is provided there shall be suitable indicators to show whether the bypass is open or closed.

#### 4. Pressure/vacuum-breaking devices

One or more pressure/vacuum-breaking devices shall be provided to prevent the cargo tanks from being subject to:

- (1) a positive pressure, in excess of the test pressure of the cargo tank, if the cargo were to be loaded at the maximum rated capacity and all other outlets are left shut; and
- (2) a negative pressure in excess of 700 mm water gauge if cargo were to be discharged at the maximum rated capacity of the cargo pumps and the inert gas blowers were to fail.

Such devices shall be installed on the inert gas main unless they are installed in the venting system required by regulation **Ch 2, 403. 1** or on individual cargo tanks. The location and design of the devices shall be in accordance with regulation **Sec 5** and **Ch 2, 403**.

**504. Size of vent outlets [See Guidance]**

Vent outlets for cargo loading, discharging and ballasting required by **501. 2** shall be designed on the basis of the maximum designed loading rate multiplied by a factor of at least 1.25 to take account of gas evolution, in order to prevent the pressure in any cargo tank from exceeding the design pressure. The master shall be provided with information regarding the maximum permissible loading rate for each cargo tank and in the case of combined venting systems, for each group of cargo tanks. ↓

## CHAPTER 10 ESCAPE

### Section 1 Notification of crew and passengers

#### 101. General emergency alarm system

A general emergency alarm system required by SOLAS shall be used for notifying crew and passengers of a fire.

#### 102. Public address systems in passenger ships

A public address system or other effective means of communication complying with the requirements of SOLAS shall be available throughout the accommodation and service spaces and control stations and open decks.

### Section 2 Means of escape

#### 201. General requirements [See Guidance]

1. Unless expressly provided otherwise in this regulation, at least two widely separated and ready means of escape shall be provided from all spaces or group of spaces.
2. Lifts shall not be considered as forming one of the means of escape as required by this regulation.

#### 202. Means of escape from control stations, accommodation and service spaces

##### 1. General requirements

- (1) Stairways and ladders shall be so arranged as to provide ready means of escape to the lifeboat and liferaft embarkation deck from passenger and crew accommodation spaces and from spaces in which the crew is normally employed, other than machinery spaces.
- (2) Unless expressly provided otherwise in this regulation, a corridor, lobby, or part of a corridor from which there is only one route of escape shall be prohibited. Dead-end corridors used in service areas which are necessary for the practical utility of the ship, such as fuel oil stations and athwartship supply corridors, shall be permitted, provided such dead-end corridors are separated from crew accommodation areas and are inaccessible from passenger accommodation areas. Also, a part of a corridor that has a depth not exceeding its width is considered a recess or local extension and is permitted.
- (3) All stairways in accommodation and service spaces and control stations shall be of steel frame construction except where the Society sanctions the use of other equivalent material.  
**[See Guidance]**
- (4) If a radiotelegraph station has no direct access to the open deck, two means of escape from or access to, the station shall be provided, one of which may be a porthole or window of sufficient size or other means to the satisfaction of the Society. **[See Guidance]**
- (5) Doors in escape routes shall, in general, open in-way of the direction of escape, except that:
  - (A) individual cabin doors may open into the cabins in order to avoid injury to persons in the corridor when the door is opened; and
  - (B) doors in vertical emergency escape trunks may open out of the trunk in order to permit the trunk to be used both for escape and for access. **[See Guidance]**

##### 2. Means of escape in passenger ships

- (1) Escape from spaces below the bulkhead deck
  - (A) Below the bulkhead deck two means of escape, at least one of which shall be independent of watertight doors, shall be provided from each watertight compartment or similarly restricted space or group of spaces. Exceptionally, the Society may dispense with one of the means of escape for crew spaces that are entered only occasionally, if the required escape route is independent of watertight doors.

- (B) Where the Society has granted dispensation under the provisions of (A), this sole means of escape shall provide safe escape. However, stairways shall not be less than 800 mm in clear width with handrails on both sides.
- (2) Escape from spaces above the bulkhead deck  
Above the bulkhead deck there shall be at least two means of escape from each main vertical zone or similarly restricted space or group of spaces at least one of which shall give access to a stairway forming a vertical escape.
- (3) Direct access to stairway enclosures  
Stairway enclosures in accommodation and service spaces shall have direct access from the corridors and be of a sufficient area to prevent congestion, having in view the number of persons likely to use them in an emergency. Within the perimeter of such stairway enclosures, only public toilets, lockers of non-combustible material providing storage for non-hazardous safety equipment and open information counters are permitted. Only corridors, lifts, public toilets, special category spaces and open ro-ro spaces to which any passengers carried can have access, other escape stairways required by (4) (A) and external areas are permitted to have direct access to these stairway enclosures. Public spaces may also have direct access to stairway enclosures except for the backstage of a theatre. Small corridors or "lobbies" used to separate an enclosed stairway from galleys or main laundries may have direct access to the stairway provided they have a minimum deck area of 4.5 m<sup>2</sup>, a width of no less than 900 mm and contain a fire hose station.
- (4) Details of means of escape
- (A) At least one of the means of escape required by (1) (A) and (2) shall consist of a readily accessible enclosed stairway, which shall provide continuous fire shelter from the level of its origin to the appropriate lifeboat and liferaft embarkation decks, or to the uppermost weather deck if the embarkation deck does not extend to the main vertical zone being considered. In the latter case, direct access to the embarkation deck by way of external open stairways and passageways shall be provided and shall have emergency lighting in accordance with regulation of SOLAS and slip-free surfaces underfoot. Boundaries facing external open stairways and passageways forming part of an escape route and boundaries in such a position that their failure during a fire would impede escape to the embarkation deck shall have fire integrity, including insulation values, in accordance with **Tables 8.7.1 to 8.7.4**, as appropriate.
- (B) Protection of access from the stairway enclosures to the lifeboat and liferaft embarkation areas shall be provided either directly or through protected internal routes which have fire integrity and insulation values for stairway enclosures as determined by **Tables 8.7.1 to 8.7.4**, as appropriate.
- (C) Stairways serving only a space and a balcony in that space shall not be considered as forming one of the required means of escape.
- (D) Each level within an atrium shall have two means of escape, one of which shall give direct access to an enclosed vertical means of escape meeting the requirements of paragraph (A).
- (E) The widths, number and continuity of escapes shall be in accordance with the requirements in the FSS Code. **【See Guidance】**
- (5) Marking of escape routes
- (A) In addition to the emergency lighting required by regulations of SOLAS, the means of escape, including stairways and exits, shall be marked by lighting or photoluminescent strip indicators placed not more than 300 mm above the deck at all points of the escape route including angles and intersections. The marking must enable passengers to identify the routes of escape and readily identify the escape exits. If electric illumination is used, it shall be supplied by the emergency source of power and it shall be so arranged that the failure of any single light or cut in a lighting strip will not result in the marking being ineffective. Additionally, escape route signs and fire equipment location markings shall be of photoluminescent material or marked by lighting. The Society shall ensure that such lighting or photoluminescent equipment has been evaluated, tested and applied in accordance with the FSS Code. **【See Guidance】**
- (B) In passenger ships carrying more than 36 passengers, the requirements of the (A) shall also apply to the crew accommodation areas.
- (C) In lieu of the escape route lighting system required by (A), alternative evacuation guidance systems may be accepted if approved by the Society based on the guidelines developed by the IMO. **【See Guidance】**
- (6) Normally locked doors that form part of an escape route

- (A) Cabin and stateroom doors shall not require keys to unlock them from inside the room. Neither shall there be any doors along any designated escape route which require keys to unlock them when moving in the direction of escape.
- (B) Escape doors from public spaces that are normally latched shall be fitted with a means of quick release. Such means shall consist of a door-latching mechanism incorporating a device that releases the latch upon the application of a force in the direction of escape flow. Quick release mechanisms shall be designed and installed to the satisfaction of the Society and, in particular:
  - (a) consist of bars or panels, the actuating portion of which extends across at least one half of the width of the door leaf, at least 760 mm and not more than 1120 mm above the deck;
  - (b) cause the latch to release when a force not exceeding 67 N is applied; and
  - (c) not be equipped with any locking device, set screw or other arrangement that prevents the release of the latch when pressure is applied to the releasing device.
- (7) Evacuation analysis for passenger ships (2019) **【See Guidance】**
  - (A) Escape routes shall be evaluated by an evacuation analysis early in the design process. This analysis shall apply to:
    - (a) ro-ro passenger ships constructed on or after 1 July 1999; and
    - (b) other passenger ships constructed on or after 1 January 2020 carrying more than 36 passengers.
  - (B) The analysis shall be used to identify and eliminate, as far as practicable, congestion which may develop during an abandonment, due to normal movement of passengers and crew along escape routes, including the possibility that crew may need to move along these routes in a direction opposite to the movement of passengers. In addition, the analysis shall be used to demonstrate that escape arrangements are sufficiently flexible to provide for the possibility that certain escape routes, assembly stations, embarkation stations or survival craft may not be available as a result of a casualty.

### 3. Means of escape in cargo ships **【See Guidance】**

- (1) At all levels of accommodation there shall be provided at least two widely separated means of escape from each restricted space or group of spaces.
- (2) Below the lowest open deck the main means of escape shall be a stairway and the second escape may be a trunk or a stairway.
- (3) Above the lowest open deck the means of escape shall be stairways or doors to an open deck or a combination thereof.
- (4) No dead-end corridors having a length of more than 7 m shall be accepted.
- (5) The width, number and continuity of escape routes shall be in accordance with the requirements in the FSS Code.
- (6) Exceptionally the Society may dispense with one of the means of escape, for crew spaces that are entered only occasionally, if the required escape route is independent of watertight doors.

### 4. Emergency escape breathing devices

- (1) Emergency escape breathing devices shall comply with the FSS Code. Spare emergency escape breathing devices shall be kept onboard. **【See Guidance】**
- (2) All ships shall carry at least two emergency escape breathing devices within accommodation spaces.
- (3) In passenger ships, at least two emergency escape breathing devices shall be carried in each main vertical zone.
- (4) In passenger ships carrying more than 36 passengers, two emergency escape breathing devices, in addition to those required in (3) above, shall be carried in each main vertical zone.
- (5) However, (3) and (4) do not apply to stairway enclosures which constitute individual main vertical zones and for the main vertical zones in the fore or aft end of a ship which do not contain spaces of categories ⑥, ⑦, ⑧, ⑫ defined in **Ch 7, 102. 3 (2) (B)**.

## 203. Means of escape from machinery spaces

### 1. Means of escape on passenger ships **【See Guidance】**

Means of escape from each machinery space in passenger ships shall comply with the following provisions.



- (1) Escape from spaces below the bulkhead deck  
Where the space is below the bulkhead deck the two means of escape shall consist of either:
  - (A) two sets of steel ladders as widely separated as possible, leading to doors in the upper part of the space similarly separated and from which access is provided to the appropriate life boat and liferaft embarkation decks. One of these ladders shall be located within a protected enclosure that satisfies **Ch 7, 102. 3 (2) ②**, or **Ch 7, 102. 4 (2) (B) ④**, as appropriate, from the lower part of the space it serves to a safe position outside the space. Self-closing fire doors of the same fire integrity standards shall be fitted in the enclosure. The ladder shall be fixed in such a way that heat is not transferred into the enclosure through non-insulated fixing points. The protected enclosure shall have minimum internal dimensions of at least 800 mm × 800 mm, and shall have emergency lighting provisions; or
  - (B) one steel ladder leading to a door in the upper part of the space from which access is provided to the embarkation deck and additionally, in the lower part of the space and in a position well separated from the ladder referred to, a steel door capable of being operated from each side and which provides access to a safe escape route from the lower part of the space to the embarkation deck.
- (2) Escape from spaces above the bulkhead deck  
Where the space is above the bulkhead deck, the two means of escape shall be as widely separated as possible and the doors leading from such means of escape shall be in a position from which access is provided to the appropriate lifeboat and liferaft embarkation decks. Where such means of escape require the use of ladders, these shall be of steel.
- (3) Dispensation from two means of escape  
In a ship of less than 1,000 gross tonnage, the Society may dispense with one of the means of escape, due regard being paid to the width and disposition of the upper part of the space. In a ship of 1,000 gross tonnage and above, the Society may dispense with one means of escape from any such space, including a normally unattended auxiliary machinery space, so long as either a door or a steel ladder provides a safe escape route to the embarkation deck, due regard being paid to the nature and location of the space and whether persons are normally employed in that space. In the steering gear space, a second means of escape shall be provided when the emergency steering position is located in that space unless there is direct access to the open deck.
- (4) Escape from machinery control rooms  
Two means of escape shall be provided from a machinery control room located within a machinery space, at least one of which will provide continuous fire shelter to a safe position outside.
- (5) Inclined ladders and stairways  
All inclined ladders/stairways fitted to comply with (1) with open treads in machinery spaces being part of or providing access to escape routes but not located within a protected enclosure shall be made of steel. Such ladders/stairways shall be fitted with steel shields attached to their undersides, such as to provide escaping personnel protection against heat and flame from beneath.
- (6) Escape from machinery control rooms in machinery spaces of category "A"  
Two means of escape shall be provided from the main workshop within a machinery space. At least one of these escape routes shall provide a continuous fire shelter to a safe position outside the machinery space.

## 2. Means of escape of cargo ships [See Guidance]

Means of escape from each machinery space in cargo ships shall comply with the following provisions.

- (1) Escape from machinery spaces of category A  
Except as provided in (2), two means of escape shall be provided from each machinery space of category A. In particular, one of the following provisions shall be complied with:
  - (A) two sets of steel ladders as widely separated as possible leading to doors in the upper part of the space similarly separated and from which access is provided to the open deck. One of these ladders shall be located within a protected enclosure that satisfies **Ch 7, 103. 3 (2) (B) ④**, from the lower part of the space it serves to a safe position outside the space. Self-closing fire doors of the same fire integrity standards shall be fitted in the enclosure. The ladder shall be fixed in such a way that heat is not transferred into the enclosure through non-insulated fixing points. The enclosure shall have minimum internal dimensions of at least 800 mm × 800 mm, and shall have emergency lighting provisions; or

- (B) one steel ladder leading to a door in the upper part of the space from which access is provided to the open deck and, additionally, in the lower part of the space and in a position well separated from the ladder referred to, a steel door capable of being operated from each side and which provides access to a safe escape route from the lower part of the space to the open deck.
- (2) Dispensation from two means of escape  
In a ship of less than 1,000 gross tonnage, the Society may dispense with one of the means of escape required under (1), due regard being paid to the dimension and disposition of the upper part of the space. In addition, the means of escape from machinery spaces of category A need not comply with the requirement for an enclosed fire shelter listed in (1) (A). In the steering gear space, a second means of escape shall be provided when the emergency steering position is located in that space unless there is direct access to the open deck.
- (3) Escape from machinery spaces other than those of category A **【See Guidance】**  
From machinery spaces other than those of category A, two escape routes shall be provided except that a single escape route may be accepted for spaces that are entered only occasionally, and for spaces where the maximum travel distance to the door is 5 m or less.
- (4) Inclined ladders and stairways  
All inclined ladders/stairways fitted to comply with (1) with open treads in machinery spaces being part of or providing access to escape routes but not located within a protected enclosure shall be made of steel. Such ladders/stairways shall be fitted with steel shields attached to their undersides, such as to provide escaping personnel protection against heat and flame from beneath.
- (5) Escape from machinery control rooms in machinery spaces of category "A"  
Two means of escape shall be provided from the machinery control room located within a machinery space. At least one of these escape routes shall provide a continuous fire shelter to a safe position outside the machinery space.
- (6) Escape from main workshops in machinery spaces of category "A"  
Two means of escape shall be provided from the main workshop within a machinery space. At least one of these escape routes shall provide a continuous fire shelter to a safe position outside the machinery space.

### 3. Emergency escape breathing devices **【See Guidance】**

- (1) On all ships, within the machinery spaces, emergency escape breathing devices shall be situated ready for use at easily visible places, which can be reached quickly and easily at any time in the event of fire. The location of emergency escape breathing devices shall take into account the layout of the machinery space and the number of persons normally working in the spaces.
- (2) The number and location of these devices shall be indicated in the fire control plan required in regulation of SOLAS.
- (3) Emergency escape breathing devices shall comply with the FSS Code.

### 204. Means of escape on passenger ships from special category and open ro-ro spaces to which any passengers carried can have access

1. In special category and open ro-ro spaces to which any passengers carried can have access, the number and locations of the means of escape both below and above the bulkhead deck shall be to the satisfaction of the Society and, in general, the safety of access to the embarkation deck shall be at least equivalent to that provided for under **202. 2 (1) (A)**, **202. 2 (2)**, **202. 2 (4) (A)**, **202. 2 (4) (B)**. Such spaces shall be provided with designated walkways to the means of escape with a breadth of at least 600 mm. The parking arrangements for the vehicles shall maintain the walkways clear at all times.
2. One of the escape routes from the machinery spaces where the crew is normally employed shall avoid direct access to any special category space.

### 205. Means of escape from ro-ro spaces **【See Guidance】**

At least two means of escape shall be provided in ro-ro spaces where the crew are normally employed. The escape routes shall provide a safe escape to the lifeboat and liferaft embarkation decks and shall be located at the fore and aft ends of the space.

## 206. Additional requirements from ro-ro passenger ships

### 1. General

- (1) Escape routes shall be provided from every normally occupied space on the ship to an assembly station. These escape routes shall be arranged so as to provide the most direct route possible to the assembly station, and shall be marked with symbols based on the guidelines developed by the IMO.
- (2) The escape route from cabins to stairway enclosures shall be as direct as possible, with a minimum number of changes in direction. It shall not be necessary to cross from one side of the ship to the other to reach an escape route. It shall not be necessary to climb more than two decks up or down in order to reach an assembly station or open deck from any passenger space.
- (3) External routes shall be provided from open decks, as referred to in (2), to the survival craft embarkation stations.
- (4) Where enclosed spaces adjoin an open deck, openings from the enclosed space to the open deck shall, where practicable, be capable of being used as an emergency exit.
- (5) Escape routes shall not be obstructed by furniture and other obstructions. With the exception of tables and chairs which may be cleared to provide open space, cabinets and other heavy furnishings in public spaces and along escape routes shall be secured in place to prevent shifting if the ship rolls or lists. Floor coverings shall also be secured in place. When the ship is underway, escape routes shall be kept clear of obstructions such as cleaning carts, bedding, luggage and boxes of goods.

### 2. Instruction for safe escape

- (1) Decks shall be sequentially numbered, starting with "1" at the tank top or lowest deck. The numbers shall be prominently displayed at stair landings and lift lobbies. Decks may also be named, but the deck number shall always be displayed with the name.
- (2) Simple "mimic" plans showing the "you are here" position and escape routes marked by arrows, shall be prominently displayed on the inside of each cabin door and in public spaces. The plan shall show the directions of escape and shall be properly oriented in relation to its position on the ship.

### 3. Strength of handrails and corridors

- (1) Handrails or other handholds shall be provided in corridors along the entire escape route so that a firm handhold is available at every step of the way, where possible, to the assembly stations and embarkation stations. Such handrails shall be provided on both sides of longitudinal corridors more than 1.8 m in width and transverse corridors more than 1 m in width. Particular attention shall be paid to the need to be able to cross lobbies, atriums and other large open spaces along escape routes. Handrails and other handholds shall be of such strength as to withstand a distributed horizontal load of 750 N/m applied in the direction of the centre of the corridor or space, and a distributed vertical load of 750 N/m applied in the downward direction. The two loads need not be applied simultaneously.
- (2) The lowest 0.5 m of bulkheads and other partitions forming vertical divisions along escape routes shall be able to sustain a load of 750 N/m to allow them to be used as walking surfaces from the side of the escape route with the ship at large angles of heel. ⚓

## CHAPTER 11 HELICOPTER FACILITIES

### Section 1 Application

#### 101. Application (2020)

1. Ships equipped with helidecks shall comply with the requirements of this regulation.
2. Where helicopters land or conduct winching operations on an occasional or emergency basis on ships without helidecks, fire-fighting equipment fitted in accordance with the requirements in **Ch 5** to **Ch 9** may be used. This equipment shall be made readily available in close proximity to the landing or winching areas during helicopter operations.
3. Notwithstanding **2** above, having a helicopter landing area, shall be provided with foam firefighting appliances which comply with the relevant provisions of chapter 17 of the FSS Code.
4. Notwithstanding **2** or **3** above, ro-ro passenger ships without helidecks shall comply with SOLAS III/28. **【See Guidance】**

### Section 2 Structure

#### 201. Structure

1. In general, the construction of the helidecks shall be of steel or other equivalent materials. If the helideck forms the deckhead of a deckhouse or superstructure, it shall be insulated to "A-60" class standard.
2. If the Society permits aluminium or other low melting point metal construction that is not made equivalent to steel, the following provisions shall be satisfied:
  - (1) if the platform is cantilevered over the side of the ship, after each fire on the ship or on the platform, the platform shall undergo a structural analysis to determine its suitability for further use; and
  - (2) if the platform is located above the ship's deckhouse or similar structure, the following conditions shall be satisfied:
    - (A) the deckhouse top and bulkheads under the platform shall have no openings;
    - (B) windows under the platform shall be provided with steel shutters; and
    - (C) after each fire on the platform or in close proximity, the platform shall undergo a structural analysis to determine its suitability for further use.

### Section 3 Means of Escape

#### 301. Means of escape

A helideck shall be provided with both a main and an emergency means of escape and access for fire fighting and rescue personnel. These shall be located as far apart from each other as is practicable and preferably on opposite sides of the helideck.

### Section 4 Fire-fighting Appliances

#### 401. Fire-fighting appliances

In close proximity to the helideck, the following fire-fighting appliances shall be provided and stored near the means of access to that helideck: **【See Guidance】**

1. at least two dry powder extinguishers having a total capacity of not less than 45 kg;

2. carbon dioxide extinguishers of a total capacity of not less than 18 kg or equivalent;
3. having a helideck, foam firefighting appliances which comply with the provisions of the Fire Safety Systems Code; (2020)
4. in addition to the requirements of regulation **Ch 8, Sec 9**, two sets of fire-fighter's outfits; and
5. at least the following equipment shall be stored in a manner that provides for immediate use and protection from the elements:
  - (1) adjustable wrench;
  - (2) blanket, fire resistant;
  - (3) cutters, bolt 60 cm;
  - (4) hook, grab or salving;
  - (5) hacksaw, heavy duty complete with 6 spare blades;
  - (6) ladder;
  - (7) lift line 5 mm diameter x 15 m in length;
  - (8) pliers, side cutting;
  - (9) set of assorted screwdrivers; and
  - (10) harness knife complete with sheath.

## Section 5 Drainage Facilities

### 501. Drainage facilities

Drainage facilities in way of helidecks shall be constructed of steel and shall lead directly overboard independent of any other system and shall be designed so that drainage does not fall onto any part of the ship.

## Section 6 Helicopter Refueling and Hanger Facilities

### 601. Helicopter refueling and hanger facilities

Where the ship has helicopter refuelling and hangar facilities, the following requirements shall be complied with:

1. A designated area shall be provided for the storage of fuel tanks which shall be:
  - (1) as remote as is practicable from accommodation spaces, escape routes and embarkation stations; and
  - (2) isolated from areas containing a source of vapour ignition;
2. the fuel storage area shall be provided with arrangements whereby fuel spillage may be collected and drained to a safe location;
3. tanks and associated equipment shall be protected against physical damage and from a fire in an adjacent space or area;
4. where portable fuel storage tanks are used, special attention shall be given to:
  - (1) design of the tank for its intended purpose;
  - (2) mounting and securing arrangements;
  - (3) electric bonding; and
  - (4) inspection procedures;
5. storage tank fuel pumps shall be provided with means which permit shutdown from a safe remote location in the event of a fire. Where a gravity fuelling system is installed, equivalent closing arrangements shall be provided to isolate the fuel source;
6. the fuel pumping unit shall be connected to one tank at a time. The piping between the tank and the pumping unit shall be of steel or equivalent material, as short as possible, and protected against damage;
7. electrical fuel pumping units and associated control equipment shall be of a type suitable for the location and potential hazards;
8. fuel pumping units shall incorporate a device which will prevent over-pressurization of the delivery or filling hose;

9. equipment used in refuelling operations shall be electrically bonded;
10. "NO SMOKING" signs shall be displayed at appropriate locations;
11. hanger, refuelling and maintenance facilities shall be treated as category 'A' machinery spaces with regard to structural fire protection, fixed fire-extinguishing and detection system requirements;
12. enclosed hanger facilities or enclosed spaces containing refuelling installations shall be provided with mechanical ventilation, as required by regulation **Ch 13, Sec 2.** for closed ro-ro spaces of cargo ships. Ventilation fans shall be of non-sparking type and complied with the requirements in **Ch 3, 104.** of the Rules; and
13. electric equipment and wiring in enclosed hanger or enclosed spaces containing refuelling installations shall comply with regulations **202., 203.** and **204.** of **Ch 13.**

## Section 7 Operations Manual and Fire-fighting Service

### 701. Operations manual and fire-fighting service

1. Each helicopter facility shall have an operations manual, including a description and a checklist of safety precautions, procedures and equipment requirements. This manual may be part of the ship's emergency response procedures.
2. The procedures and precautions to be followed during refuelling operations shall be in accordance with recognized safe practices and contained in the operations manual.
3. Fire-fighting personnel consisting of at least two persons trained for rescue and fire-fighting duties and fire-fighting equipment shall be immediately available at all times when helicopter operations are expected.
4. Fire-fighting personnel shall be present during refuelling operations. However, the fire-fighting personnel shall not be involved with refuelling activities.
5. On-board refresher training shall be carried out and additional supplies of fire-fighting media shall be provided for training and testing of the equipment. ⚡

## CHAPTER 12 CARRIAGE OF DANGEROUS GOODS

### Section 1 General Requirements

#### 101. General requirements [See Guidance]

1. In addition, ship types and cargo spaces, referred to in **2**, intended for the carriage of dangerous goods shall comply with the requirements of this regulation, as appropriate, except when carrying dangerous goods in limited quantities and excepted quantities unless such requirements have already been met by compliance with the requirements elsewhere in this chapter. The types of ships and modes of carriage of dangerous goods are referred to in **2** and in **Table 8.12.1**. Cargo ships of less than 500 gross tonnage shall comply with this regulation, but Society may reduce the requirements and such reduced requirements shall be recorded in the document of compliance.
2. The following ship types and cargo spaces shall govern the application of **Tables 8.12.1** and **8.12.2**:
  - (1) ships and cargo spaces not specifically designed for the carriage of freight containers, but intended for the carriage of dangerous goods in packaged form including goods in freight containers and portable tanks;
  - (2) purpose-built container ships and cargo spaces intended for the carriage of dangerous goods in freight containers and portable tanks.
  - (3) ro-ro ships and ro-ro spaces intended for the carriage of dangerous goods.
  - (4) ships and cargo spaces intended for the carriage of solid dangerous goods in bulk; and
  - (5) ships and cargo spaces intended for carriage of dangerous goods other than liquids and gases in bulk in shipborne barges.

### Section 2 Special Requirements

#### 201. Special requirements [See Guidance]

Unless otherwise specified, the following requirements shall govern the application of **Tables 8.12.1**, **8.12.2** and **8.12.3** to both "on-deck" and "under-deck" stowage of dangerous goods where the numbers of the following paragraphs are indicated in the first column of the tables.

##### 1. Water supplies [See Guidance]

- (1) Arrangements shall be made to ensure immediate availability of a supply of water from the fire main at the required pressure either by permanent pressurization or by suitably placed remote arrangements for the fire pumps.
- (2) The quantity of water delivered shall be capable of supplying four nozzles of a size and at pressures as specified in **Ch. 8, Sec 1** capable of being trained on any part of the cargo space when empty. This amount of water may be applied by equivalent means to the satisfaction of the Society.
- (3) Means shall be provided for effectively cooling the designated underdeck cargo space by at least 5 L/min per square meter of the horizontal area of cargo spaces, either by a fixed arrangement of spraying nozzles or flooding the cargo space with water. Hoses may be used for this purpose in small cargo spaces and in small areas of larger cargo spaces at the discretion of the Society. However, the drainage and pumping arrangements shall be such as to prevent the build-up of free surfaces. The drainage system shall be sized to remove no less than 125% of the combined capacity of both the water spraying system pumps and the required number of fire hose nozzles. The drainage system valves shall be operable from outside the protected space at a position in the vicinity of the extinguishing system controls. Bilge wells shall be of sufficient holding capacity and shall be arranged at the side shell of the ship at a distance from each other of not more than 40 m in each watertight compartment. If this is not possible, the adverse effect upon stability of the added weight and free surface of water shall be taken into account to the extent deemed necessary by the Society in its approval of the stability information.
- (4) Provision to flood a designated under-deck cargo space with suitable specified media may be substituted for the requirements in (3).

- (5) The total required capacity of the water supply shall satisfy (2) and (3), if applicable, simultaneously calculated for the largest designated cargo space. The capacity requirements of (2) shall be met by the total capacity of the main fire pump(s) not including the capacity of the emergency fire pump, if fitted. If a drencher system is used to satisfy (3), the drencher pump shall also be taken into account in this total capacity calculation.

## 2. Sources of ignition **【See Guidance】**

Electrical equipment and wiring shall not be fitted in enclosed cargo spaces or vehicle spaces unless it is essential for operational purposes in the opinion of the Society. However, if electrical equipment is fitted in such spaces, it shall be of a certified safe type for use in the dangerous environments to which it may be exposed unless it is possible to completely isolate the electrical system (e.g. by removal of links in the system, other than fuses). Cable penetrations of the decks and bulkheads shall be sealed against the passage of gas or vapour. Through runs of cables and cables within the cargo spaces shall be protected against damage from impact. Any other equipment which may constitute a source of ignition of flammable vapour shall not be permitted.

## 3. Detection system

Ro-ro spaces shall be fitted with a fixed fire detection and fire alarm system complying with the requirements of the FSS Code. All other types of cargo spaces shall be fitted with either a fixed fire detection and fire alarm system or a sample extraction smoke detection system complying with the requirements of the FSS Code. If a sample extraction smoke detection system is fitted, particular attention shall be made to the FSS Code in order to prevent the leakage of toxic fumes into occupied areas.

## 4. Ventilation arrangement **【See Guidance】**

- (1) Adequate power ventilation shall be provided in enclosed cargo spaces. The arrangement shall be such as to provide for at least six air changes per hour in the cargo space based on an empty cargo space and for removal of vapours from the upper or lower parts of the cargo space, as appropriate.
- (2) The fans shall be such as to avoid the possibility of ignition of flammable gas air mixtures. Suitable wire mesh guards shall be fitted over inlet and outlet ventilation openings.
- (3) Natural ventilation shall be provided in enclosed cargo spaces intended for the carriage of solid dangerous goods in bulk, where there is no provision for mechanical ventilation.

## 5. Bilge pumping **【See Guidance】**

- (1) Where it is intended to carry flammable (liquids with flash point less than 23 °C) or toxic liquids in enclosed cargo spaces, the bilge pumping system shall be designed to protect against inadvertent pumping of such liquids through machinery space piping or pumps. Where large quantities of such liquids are carried, consideration shall be given to the provision of additional means of draining those cargo spaces.
- (2) If the bilge drainage system is additional to the system served by pumps in the machinery space, the capacity of the system shall be not less than 10 m<sup>3</sup>/h per cargo space served. If the additional system is common, the capacity need not exceed 25 m<sup>3</sup>/h. The additional bilge system need not be arranged with redundancy.
- (3) Whenever flammable or toxic liquids are carried, the bilge line into the machinery space shall be isolated either by fitting a blank flange or by a closed lockable valve.
- (4) Enclosed spaces outside machinery spaces containing bilge pumps serving cargo spaces intended for carriage of flammable or toxic liquids should be fitted with separate mechanical ventilation giving at least 6 air changes per hour. If the space has access from another enclosed space, the door shall be self-closing.
- (5) If bilge drainage of cargo spaces is arranged by gravity drainage, the drainage shall be either led directly overboard or to a closed drain tank located outside the machinery spaces. The tank shall be provided with a vent pipe to a safe location on the open deck. Drainage from a cargo space into bilge wells in a lower space is only permitted if that space satisfies the same requirements as the cargo space above.

## 6. Personnel protection **【See Guidance】**

- (1) Four sets of full protective clothing resistant to chemical attack shall be provided in addition to the fire-fighter's outfits required by **Ch 8, Sec 9** and shall be selected taking into account the hazards associated with the chemicals being transported and the recognized standards developed



according to the class and physical state. The protective clothing shall cover all skin, so that no part of the body is unprotected.

- (2) At least two self-contained breathing apparatuses additional to those required by **Ch 8, Sec 9** shall be provided. Two spare charges suitable for use with the breathing apparatus shall be provided for each required apparatus. Passenger ships carrying not more than 36 passengers and cargo ships that are equipped with suitably located means for fully recharging the air cylinders free from contamination, need carry only one spare charge for each required apparatus.

#### **7. Portable fire extinguishers [See Guidance]**

Portable fire extinguishers with a total capacity of at least 12 kg of dry powder or equivalent shall be provided for the cargo spaces. These extinguishers shall be in addition to any portable fire extinguishers required elsewhere in this chapter.

#### **8. Insulation of machinery space boundaries [See Guidance]**

Bulkheads forming boundaries between cargo spaces and machinery spaces of category A shall be insulated to "A-60" class standard, unless the dangerous goods are stowed at least 3 m horizontally away from such bulkheads. Other boundaries between such spaces shall be insulated to "A-60" class standard.

#### **9. Water spray system**

Each open ro-ro space having a deck above it and each space deemed to be a closed ro-ro space not capable of being sealed, shall be fitted with an approved fixed pressure water-spraying system for manual operation which shall protect all parts of any deck and vehicle platform in the space, except that the Society may permit the use of any other fixed fire-extinguishing system that has been shown by full-scale test to be no less effective. However, the drainage and pumping arrangements shall be such as to prevent the build-up of free surfaces. The drainage system shall be sized to remove no less than 125 % of the combined capacity of both the water spraying system pumps and the required number of fire hose nozzles. The drainage system valves shall be operable from outside the protected space at a position in the vicinity of the extinguishing system controls. Bilge wells shall be of sufficient holding capacity and shall be arranged at the side shell of the ship at a distance from each other of not more than 40 m in each watertight compartment. If this is not possible the adverse effect upon stability of the added weight and free surface of water shall be taken into account to the extent deemed necessary by the Society in its approval of the stability information.

#### **10. Separation of ro-ro spaces**

- (1) In ships having ro-ro spaces, a separation shall be provided between a closed ro-ro space and an adjacent open ro-ro space. The separation shall be such as to minimize the passage of dangerous vapours and liquids between such spaces. Alternatively, such separation need not be provided if the ro-ro space is considered to be a closed cargo space over its entire length and shall fully comply with the relevant special requirements of this regulation.
- (2) In ships having ro-ro spaces, a separation shall be provided between a closed ro-ro space and the adjacent weather deck. The separation shall be such as to minimize the passage of dangerous vapours and liquids between such spaces. Alternatively, a separation need not be provided if the arrangements of the closed ro-ro spaces are in accordance with those required for the dangerous goods carried on adjacent weather deck.

**Table 8.12.1 Application of the requirements to different modes of carriage of dangerous goods in ships and cargo spaces. [See Guidance]**

Regulation 101.2 Ch 12	Weather decks (1) to (5) inclusive	(1) Not specifically designed	(2) Container cargo spaces	(3)		(4) Solid dangerous goods in bulk	(5) Shipborne barges
				Closed ro-ro cargo spaces <sup>5</sup>	Open ro-ro cargo spaces		
201. 1 (1)	x	x	x	x	x	For application of requirements of regulation <b>Ch. 12</b> to different classes of dangerous goods. See <b>table 8.12.2</b>	x
201. 1 (2)	x	x	x	x	x		-
201. 1 (3)	-	x	x	x	x		x
201. 1 (4)	-	x	x	x	x		x
201. 2	-	x	x	x	x		x <sup>4</sup>
201. 3	-	x	x	x	-		x <sup>4</sup>
201. 4 (1)	-	x	x <sup>1</sup>	x	-		x <sup>4</sup>
201. 4 (2)	-	x	x <sup>1</sup>	x	-		x <sup>4</sup>
201. 5	-	x	x	x	-		-
201. 6 (1)	x	x	x	x	x		-
201. 6 (2)	x	x	x	x	x		-
201. 7	x	x	-	-	x		-
201. 8	x	x	x <sup>2</sup>	x	x		-
201. 9	-	-	-	x <sup>3</sup>	x		-
201. 10 (1)	-	-	-	x	-		-
201. 10 (2)	-	-	-	x	-		-

Where "x" appears in **Table 8.12.1** it means this requirement is applicable to all classes of dangerous goods as given in the appropriate line of **Table 8.12.3**, except as indicated by the notes.

Notes :

1. For classes 4 and 5.1 solids not applicable to closed freight containers. For classes 2, 3, 6.1 and 8 when carried in closed freight containers, the ventilation rate may be reduced to not less than two air changes per hour. For classes 4 and 5.1 liquids when carried in closed freight containers, the ventilation rate may be reduced to not less than two air changes per hour. For the purpose of this requirement, a portable tank is a closed freight container.
2. Applicable to decks only.
3. Applies only to closed ro-ro spaces, not capable of being sealed.
4. In the special case where the barges are capable of containing flammable vapours or alternatively if they are capable of discharging flammable vapours to a safe space outside the barge carrier compartment by means of ventilation ducts connected to the barges, these requirements may be reduced or waived to the satisfaction of the Society.
5. Special category spaces shall be treated as closed ro-ro spaces when dangerous goods are carried.

**Table 8.12.2 Application of the requirements to different classes of dangerous goods for ships and cargo spaces carrying solid dangerous goods in bulk**

Class	4.1	4.2	4.36	5.1	6.1	8	9
Ch 12							
201. 1 (1)	x	x	-	x	-	-	x
201. 1 (2)	x	x	-	x	-	-	x
201. 2	x	x <sup>7</sup>	x	x <sup>8</sup>	-	-	x <sup>8</sup>
201. 4 (1)	-	x <sup>7</sup>	x	-	-	-	-
201. 4 (2)	x <sup>9</sup>	x <sup>7</sup>	x	x <sup>7,9</sup>	-	-	x <sup>7,9</sup>
201. 4 (3)	x	x	x	x	x	x	x
201. 6	x	x	x	x	x	x	x
201. 8	x	x	x	x <sup>7</sup>	-	-	x <sup>10</sup>

Notes:

6. The hazards of substances in this class which may be carried in bulk are such that special consideration must be given by the Society to the construction and equipment of the ship involved in addition to meeting the requirements enumerated in this table.
7. Only applicable to Seedcake containing solvent extractions, to Ammonium nitrate and to Ammonium nitrate fertilizers.
8. Only applicable to Ammonium nitrate and to Ammonium nitrate fertilizers. However, a degree of protection in accordance with standards contained in the International Electrotechnical Commission publication 60079, Electrical Apparatus for Explosive Gas Atmospheres, is sufficient.
9. Only suitable wire mesh guards are required.
10. The requirements of the International Maritime Solid Bulk Cargoes (IMSBC) Code, as amended, are sufficient.

**Table 8.12.3 Application of the requirements to different classes of dangerous goods except solid dangerous goods in bulk**

Class	1.1 to 1.6	1.4S	2.1	2.2	2.3 flammable	2.3 non-flammable	3 FP <sup>15</sup> < 23°C	3 23°C ≤ FP <sup>15</sup> ≤ 60°C	4.1	4.2	4.3 liquids	4.3 solids	5.1	5.2 <sup>16</sup>	6.1 liquids FP <sup>15</sup> < 23°C	6.1 liquids 23°C ≤ FP <sup>15</sup> ≤ 60°C	6.1 liquids	6.1 solids	8 liquids FP <sup>15</sup> < 23°C	8 liquids 23°C ≤ FP <sup>15</sup> ≤ 60°C	8 liquids	8 solids	9
Ch 12																							
201.1(1)	x	x	x	x	x	x	x	x	x	x	x	x	x	x	x	x	x	x	x	x	x	x	x
201.1(2)	x	x	x	x	x	x	x	x	x	x	x	x	x	x	x	x	x	x	x	x	x	x	-
201.1(3)	x	-	-	-	-	-	-	-	-	-	-	-	-	-	-	-	-	-	-	-	-	-	-
201.1(4)	x	-	-	-	-	-	-	-	-	-	-	-	-	-	-	-	-	-	-	-	-	-	-
201.2	x	-	x	-	x	-	x	-	-	-	x <sup>18</sup>	-	-	-	x	-	-	-	x	-	-	-	x <sup>17</sup>
201.3	x	x	x	x	-	x	x	x	x	x	x	x	-	x	x	x	x	x	x	x	x	x	-
201.4(1)	-	-	x	-	-	x	x	-	x <sup>11</sup>	x <sup>11</sup>	x	x	x <sup>11</sup>	-	x	x	-	x <sup>11</sup>	x	x	-	-	x <sup>11</sup>
201.4(2)	-	-	x	-	-	-	x	-	-	-	-	-	-	-	x	-	-	-	x	-	-	-	x <sup>17</sup>
201.5	-	-	-	-	-	-	x	-	-	-	-	-	-	-	x	x	x	-	x	x <sup>19</sup>	x <sup>19</sup>	-	-
201.6	-	-	x	x	x	x	x	x	x	x	x	x	x	x	x	x	x	x	x	x	x	x	x <sup>14</sup>
201.7	-	-	-	-	-	-	x	x	x	x	x	x	-	x	x	x	-	-	x	x	-	-	-
201.8	x <sup>12</sup>	-	x	x	x	x	x	x	x	x	x	x	x <sup>13</sup>	x	x	x	-	-	x	x	-	-	-
201.9	x	x	x	x	x	x	x	x	x	x	x	x	x	x	x	x	x	x	x	x	x	x	x
201.10(1)	x	x	x	x	x	x	x	x	x	x	x	x	x	x	x	x	x	x	x	x	x	x	x
201.10(2)	x	x	x	x	x	x	x	x	x	x	x	x	x	x	x	x	x	x	x	x	x	x	x

Notes

11. When "mechanically-ventilated spaces" are required by the International Maritime Dangerous Goods Code, as amended.
12. Stow 3 m horizontally away from the machinery space boundaries in all cases.
13. Refer to the International Maritime Dangerous Goods Code, as amended.
14. As appropriate to the goods to be carried.
15. FP means flashpoint.
16. Under the provisions of the IMDG Code, stowage of class 5.2 dangerous goods under deck or in enclosed ro-ro spaces is prohibited.
17. Only applicable to dangerous goods evolving flammable vapour listed in the IMDG Code.
18. Only applicable to dangerous goods having a flashpoint less than 23°C listed in the IMDG Code.
19. Only applicable to dangerous goods having a subsidiary risk class 6.1.
20. Under the provisions of the IMDG Code, stowage of class 2.3 having subsidiary risk class 2.1 under deck or in enclosed ro-ro spaces is prohibited.
21. Under the provisions of the IMDG Code, stowage of class 4.3 liquids having a flashpoint less than 23°C under deck or in enclosed ro-ro spaces is prohibited.

---

### Section 3 Document of Compliance

#### 301. Document of Compliance **【See Guidance】**

The Administration shall provide the ship with an appropriate document as evidence of compliance of construction and equipment with the requirements of this chapter. Certification for dangerous goods, except solid dangerous goods in bulk, is not required for those cargoes specified as class 6.2 and 7 and dangerous goods in limited quantities and excepted quantities. ⚓

## CHAPTER 13 PROTECTION OF VEHICLE, SPECIAL CATEGORY AND RO-RO SPACES

### Section 1 General Requirements

#### 101. Application

1. In addition, as appropriate, vehicle, special category and ro-ro spaces shall comply with the requirements of this regulation.
2. On all ships, vehicles with fuel in their tanks for their own propulsion may be carried in cargo spaces other than vehicle, special category or ro-ro spaces, provided that all the following conditions are met: (2020)
  - (1) the vehicles do not use their own propulsion within the cargo spaces;
  - (2) the cargo spaces are in compliance with the appropriate requirements of regulation 19; and
  - (3) the vehicles are carried in accordance with the IMDG Code, as defined in SOLAS VII/1.1."

#### 102. Basic principles for passenger ships

1. The basic principle underlying the provisions of this regulation is that the main vertical zoning required by **Ch 7, Sec 1** may not be practicable in vehicle spaces of passenger ships and, therefore, equivalent protection must be obtained in such spaces on the basis of a horizontal zone concept and by the provision of an efficient fixed fire-extinguishing system. Based on this concept, a horizontal zone for the purpose of this regulation may include special category spaces on more than one deck provided that the total overall clear height for vehicles does not exceed 10 m. **[See Guidance]**
2. The basic principle underlying the provisions of **1.** are also applicable to ro-ro spaces.
3. The requirements of ventilation systems, openings in "A" class divisions and penetrations in "A" class divisions for maintaining the integrity of vertical zones in this chapter shall be applied equally to decks and bulkheads forming the boundaries separating horizontal zones from each other and from the remainder of the ship.

### Section 2 Precaution against ignition of flammable vapours in closed vehicle spaces closed ro-ro spaces and special category spaces

#### 201. Ventilation systems

##### 1. Capacity of ventilation systems

There shall be provided an effective power ventilation system sufficient to give at least the following air changes. The Society may require an increased number of air changes when vehicles are being loaded and unloaded.

- (1) In case passenger ships
  - (A) Special category spaces ; 10 air changes per hour
  - (B) Closed ro-ro and vehicle spaces other than special category spaces for ships carrying more than 36 passengers ; 10 air changes per hour
  - (C) Closed ro-ro and vehicle spaces other than special category spaces for ships carrying not more than 36 passengers ; 6 air changes per hour
- (2) In case cargo ships ; 6 air changes per hour

##### 2. Performance of ventilation systems shall be satisfied as follows.

- (1) In passenger ships, the power ventilation system shall be separated from other ventilation systems. The power ventilation system shall be operated to give at least the number of air changes required in **1** at all times when vehicles are in such spaces, except where an air quality control system in accordance with (4) is provided. Ventilation ducts serving such cargo spaces capable of being effectively sealed shall be separated for each such space. The system shall be

capable of being controlled from a position outside such spaces. (2018)

- (2) In cargo ships, the ventilation fans shall normally be run continuously and give at least the number of air changes required in **1** whenever vehicles are on board, except where an air quality control system in accordance with (4) is provided. Where this is impracticable, they shall be operated for a limited period daily as weather permits and in any case for a reasonable period prior to discharge, after which period the ro-ro or vehicle space shall be proved gas-free. One or more portable combustible gas detecting instruments shall be carried for this purpose. The system shall be entirely separate from other ventilating systems. Ventilation ducts serving ro-ro or vehicle spaces shall be capable of being effectively sealed for each cargo space. The system shall be capable of being controlled from a position outside such spaces. (2018)
- (3) The ventilation system shall be such as to prevent air stratification and the formation of air pockets.
- (4) For all ships, where an air quality control system is provided based on the guidelines developed by IMO, the ventilation system may be operated at a decreased number of air changes and/or a decreased amount of ventilation. This relaxation does not apply to spaces to which at least ten air changes per hour is required by **202. 2** and spaces subject to **Sec.6** and **Ch 12, 201. 4** (1). (2018) **【See Guidance】**

### **3. Indication of ventilation systems 【See Guidance】**

Means shall be provided on the navigation bridge to indicate any loss of the required ventilating capacity.

### **4. Closing appliances and ducts**

- (1) Arrangements shall be provided to permit a rapid shutdown and effective closure of the ventilation system from outside of the space in case of fire, taking into account the weather and sea conditions. **【See Guidance】**
- (2) Ventilation ducts, including dampers, within a common horizontal zone shall be made of steel. In passenger ships, ventilation ducts that pass through other horizontal zones or machinery spaces shall be "A-60" class steel ducts constructed in accordance with **Ch 7, 602..**

### **5. Permanent openings 【See Guidance】**

Permanent openings in the side plating, the ends or deckhead of the space shall be so situated that a fire in the cargo space does not endanger stowage areas and embarkation stations for survival craft and accommodation spaces, service spaces and control stations in superstructures and deckhouses above the cargo spaces.

## **202. Electrical equipment and wiring 【See Guidance】**

1. Except as provided in **2**, electrical equipment and wiring shall be of a type suitable for use in an explosive petrol and air mixture.
2. In case of other than special category spaces below the bulkhead deck, notwithstanding the provisions in **1**, above a height of 450 mm from the deck and from each platform for vehicles, if fitted, except platforms with openings of sufficient size permitting penetration of petrol gases downwards, electrical equipment of a type so enclosed and protected as to prevent the escape of sparks shall be permitted as an alternative on condition that the ventilation system is so designed and operated as to provide continuous ventilation of the cargo spaces at the rate of at least ten air changes per hour whenever vehicles are on board.

## **203. Electrical equipment and wiring in exhaust ventilation ducts 【See Guidance】**

Electrical equipment and wiring, if installed in an exhaust ventilation duct, shall be of a type approved for use in explosive petrol and air mixtures and the outlet from any exhaust duct shall be sited in a safe position, having regard to other possible sources of ignition.

## **204. Other ignition sources**

Other equipment which may constitute a source of ignition of flammable vapours shall not be permitted.

### 205. Scuppers and discharges

Scuppers shall not be led to machinery or other spaces where sources of ignition may be present.

## Section 3 Detection and alarm

### 301. Fixed fire detection and fire alarm systems [See Guidance]

Except as provided in **303.1**, there shall be provided a fixed fire detection and fire alarm system complying with the requirements of the FSS Code. The fixed fire detection system shall be capable of rapidly detecting the onset of fire. The type of detectors and their spacing and location shall be to the satisfaction of the Society taking into account the effects of ventilation and other relevant factors. After being installed the system shall be tested under normal ventilation conditions and shall give an overall response time to the satisfaction of the Society.

### 302. Sample extraction smoke detection systems

Except open ro-ro spaces, open vehicle spaces and special category spaces, a sample extraction smoke detection system complying with the requirements of the FSS Code may be used as an alternative of the fixed fire detection and fire alarm system required in **301.**

### 303. Special category spaces

1. An efficient fire patrol system shall be maintained in special category spaces. However, if an efficient fire patrol system is maintained by a continuous fire watch at all times during the voyage, a fixed fire detection and fire alarm systems is not required.
2. Manually operated call points shall be spaced so that no part of the space is more than 20 m from a manually operated call point, and one shall be placed close to each exit from such spaces.

## Section 4 Structure protection

### 401. Structure protection

Notwithstanding the provisions of **Ch 7, 102.**, in passenger ships carrying more than 36 passengers, the boundary bulkheads and decks of special category spaces and ro-ro spaces shall be insulated to "A-60" class standard. However, where a category ⑤, ⑨, ⑩ space, as defined in regulation **Ch 7, 102.2 (3)(B)**, is on one side of the division the standard may be reduced to "A-0". Where fuel oil tanks are below a special category space or a ro-ro space, the integrity of the deck between such spaces, may be reduced to "A-0" standard.

## Section 5 Fire-extinction

### 501. Fixed fire-extinguishing systems

1. Vehicle spaces and ro-ro spaces which are not special category spaces and are capable of being sealed from a location outside of the cargo spaces shall be fitted with one of the following fixed fire-extinguishing system:
  - (1) a fixed gas fire-extinguishing system complying with the provisions of the FSS Code;
  - (2) a fixed high-expansion foam fire-extinguishing system complying with the provisions of the FSS Code; or
  - (3) a fixed water-based fire fighting system complying with the provisions of the FSS Code and **2 (1) to (4)**. [See Guidance]
2. Vehicle spaces and ro-ro spaces not capable of being sealed and special category spaces shall be fitted with a fixed water-based fire-fighting system for ro-ro spaces and special category spaces

complying with the provisions of the the FSS Code which shall protect all parts of any deck and vehicle platform in such spaces. Such a water-based fire-fighting system shall have: **【See Guidance】**

- (1) a pressure gauge on the valve manifold;
  - (2) clear marking on each manifold valve indicating the spaces served;
  - (3) instructions for maintenance and operation located in the valve room; and
  - (4) a sufficient number of drainage valves to ensure complete drainage of the system.
3. The Society may permit the use of any other fixed fire-extinguishing system that has been shown that it is not less effective by a full-scale test in conditions simulating a flowing petrol fire in a vehicle space or a ro-ro space in controlling fires likely to occur in such a space.
4. When fixed pressure water-spraying systems are provided, in view of the serious loss of stability which could arise due to large quantities of water accumulating on the deck or decks during the operation of the fixed pressure water-spraying system; the following arrangements shall be provided:
- (1) in passenger ships: **【See Guidance】**
    - (A) in the spaces above the bulkhead deck, scuppers shall be fitted so as to ensure that such water is rapidly discharged directly overboard, taking into account the guidelines of MSC.1/Circ.1320;
    - (B) in ro-ro passenger ships discharge valves for scuppers, fitted with positive means of closing operable from a position above the bulkhead deck in accordance with the requirements of the International Convention on Load Lines in force, shall be kept open while the ships are at sea;
    - (C) any operation of valves referred to in paragraph (B) shall be recorded in the log-book;
    - (D) in the spaces below the bulkhead deck, the Society may require pumping and drainage facilities to be provided additional to the requirements of regulation of SOLAS. In such case, the drainage system shall be sized to remove no less than 125 % of the combined capacity of both the water spraying system pumps and the required number of fire hose nozzles, taking into account the guidelines of MSC.1/Circ.1320. The drainage system valves shall be operable from outside the protected space at a position in the vicinity of the extinguishing system controls. Bilge wells shall be of sufficient holding capacity and shall be arranged at the side shell of the ship at a distance from each other of not more than 40 m in each watertight compartment;
  - (2) in cargo ships,  
the drainage and pumping arrangements shall be such as to prevent the build-up of free surfaces. In such case, the drainage system shall be sized to remove no less than 125 % of the combined capacity of both the water spraying system pumps and the required number of fire hose nozzles, taking into account the guidelines of MSC.1/Circ.1320. The drainage system valves shall be operable from outside the protected space at a position in the vicinity of the extinguishing system controls. Bilge wells shall be of sufficient holding capacity and shall be arranged at the side shell of the ship at a distance from each other of not more than 40 m in each watertight compartment. If this is not possible the adverse effect upon stability of the added weight and free surface of water shall be taken into account to the extent deemed necessary by the Society in its approval of the stability information.\* Such information shall be included in the stability information supplied to the master as required by regulation of SOLAS.
5. On all ships, for closed vehicles and ro-ro spaces and special category spaces, where fixed pressure water-spraying systems are fitted, means shall be provided to prevent the blockage of drainage arrangements, taking into account the guidelines of MSC.1/Circ.1320. Ships constructed before 1 January 2010 shall comply with the requirements of this paragraph by the first survey after 1 January 2010.

## 502. Portable fire extinguishers

1. Portable extinguishers shall be provided at each deck level in each hold or compartment where vehicles are carried, spaced not more than 20 m apart on both sides of the space. At least one portable fire-extinguisher shall be located at each access to such a cargo space.
2. In addition to the provision of 1, the following fire extinguishing appliances shall be provided in vehicle, ro-ro and special category spaces intended for the carriage of motor vehicles with fuel in their tanks for their own propulsion: **【See Guidance】**



- (1) at least three water-fog applicators; and
- (2) one portable foam applicator unit complying with the provisions of the FSS Code, provided that at least two such units are available in the ship for use in such ro-ro spaces.

## **Section 6 Requirements for vehicle carriers carrying motor vehicles with compressed hydrogen or natural gas in their tanks for their own propulsion as cargo (2017)**

### **601. Purpose**

1. The purpose of this section is to provide additional safety measures in order to address the fire safety objectives of this chapter for vehicle carriers with vehicle and ro-ro spaces intended for carriage of motor vehicles with compressed hydrogen or compressed natural gas in their tanks for their own propulsion as cargo.

### **602. Requirements for spaces intended for carriage of motor vehicles with compressed natural gas in their tanks for their own propulsion as cargo**

#### **1. Electrical equipment and wiring**

- (1) All electrical equipment and wiring are to be of a certified safe type for use in an explosive methane and air mixture.

#### **2. Ventilation arrangement**

- (1) Electrical equipment and wiring, if installed in any ventilation duct, are to be of a certified safe type for use in explosive methane and air mixtures.
- (2) The fans are to be such as to avoid the possibility of ignition of methane and air mixtures. Suitable wire mesh guards are to be fitted over inlet and outlet ventilation openings.

#### **3. Other ignition sources**

Other equipment which may constitute a source of ignition of methane and air mixtures is not be permitted.

### **603. Requirements for spaces intended for carriage of motor vehicles with compressed hydrogen in their tanks for their own propulsion as cargo**

#### **1. Electrical equipment and wiring**

- (1) All electrical equipment and wiring are to be of a certified safe type for use in an explosive hydrogen and air mixture.

#### **2. Ventilation arrangement**

- (1) Electrical equipment and wiring, if installed in any ventilation duct, are to be of a certified safe type for use in explosive hydrogen and air mixtures and the outlet from any exhaust duct is to be sited in a safe position, having regard to other possible sources of ignition.
- (2) The fans are to be designed such as to avoid the possibility of ignition of hydrogen and air mixtures. Suitable wire mesh guards are to be fitted over inlet and outlet ventilation openings.

#### **3. Other ignition sources**

- (1) Other equipment which may constitute a source of ignition of hydrogen and air mixtures is not be permitted.

### **604. Detection**

1. At least two portable gas detectors are to be provided. Such detectors are to be suitable for the detection of the gas fuel and be of a certified safe type for use in the explosive gas and air mixture. ↓

---

## CHAPTER 14 SAFETY RETURN TO PORT SYSTEM ON PASSENGER SHIPS

### Section 1 General

#### 101. Application [See Guidance]

Safety return to port system on passenger ships shall apply to the requirements in accordance with **Annex 8-7** of the Guidance. ↴



2024

Guidance Relating to  
the Rules for the Classification of Steel Ships

---

Part 8

Fire Protection and Fire Extinction

#### APPLICATION OF THE GUIDANCE RELATING TO THE RULES

This "Guidance relating to the Rules for Classification of Steel Ships" (hereafter called as the Guidance Relating to the Rules) is prepared with the intent of giving details as to the treatment of the various provisions for items required the unified interpretations and items not specified in the Rules, and the requirements specified in the Guidance Relating to the Rules are to be applied, in principle, in addition to the various provisions in the Rules.

As to any technical modifications which can be regarded as equivalent to any requirements in the Guidance Relating to the Rules, their flexible application will be properly considered.

## APPLICATION OF PART 8 "FIRE PROTECTION AND FIRE EXTINCTION"

1. Unless expressly specified otherwise, the requirements in the Guidance apply to ships for which constructed on or after 1 July 2024.
2. The amendments to the Rules for 2023 edition and their effective date are as follows;

**Effective Date** 5 June 2023 (Date of contract for construction)

---

### **CHAPTER 7 CONTAINMENT OF FIRE**

#### **Section 6 Ventilation Systems**

- 602. 2 has been amended.

**Effective Date** 1 July 2024

---

### **CHAPTER 7 CONTAINMENT OF FIRE**

#### **Section 6 Ventilation Systems**

- 603. 4 has been amended.

### **CHAPTER 8 FIRE FIGHTING**

#### **Section 1 Water Supply System**

- 102. 3 has been amended.

### **<Annex> FIRE FIGHTING**

**Annex 8-3 Special Requirements for Ships which are not engaged in international voyage or Ships of less than 500 gross tonnage (Fire-fighting system of ships which are subject to Ships Safety Law of the Korean Government, but not SOLAS, shall follow the relevant requirements)**

- 1 (3) (F) has been newly added.

**Annex 8-9 Special Requirements of Fire Protection and Fire Extinction for Cargo Ships**

- Section 1 101. (3) (B) (b) has been amended.
- Section 4 402. 1 (2) has been amended.

Effective Date : 1 July 2024 (the date of which application for survey is submitted)

---

**CHAPTER 2    PROBABILITY OF IGNITION**

**Section 4    Cargo Areas of Tankers**

- 402. 1 has been amended.

# CONTENTS

<b>CHAPTER 1 GENERAL</b> .....	<b>1</b>
Section 1 General .....	1
<b>CHAPTER 2 PROBABILITY OF IGNITION</b> .....	<b>5</b>
Section 1 Arrangements for Oil Fuel, Lubrication Oil and Other Flammable Oils .....	5
Section 2 Arrangements for Gaseous Fuel for Domestic Purpose .....	7
Section 3 Miscellaneous Items of Ignition Sources and Ignitability .....	7
Section 4 Cargo Areas of Tankers .....	8
<b>CHAPTER 3 FIRE GROWTH POTENTIAL</b> .....	<b>17</b>
Section 1 Control of Air Supply and Flammable Liquid to The Spaces .....	17
Section 2 Fire Protection Materials .....	18
<b>CHAPTER 4 SMOKE GENERATION POTENTIAL AND TOXICITY</b> .....	<b>19</b>
Section 1 Paints, Varnishes and Other Finishes .....	19
Section 2 Primary Deck Coverings .....	19
<b>CHAPTER 5 DETECTION AND ALARM</b> .....	<b>21</b>
Section 1 General .....	21
Section 2 Protection of Machinery Spaces .....	21
Section 3 Protection of Accommodation and Service Spaces and Control Stations .....	22
Section 5 Manually Operated Call Points .....	24
Section 8 Protection of cabin balconies on passenger ships .....	24
<b>CHAPTER 6 CONTROL OF SMOKE SPEED</b> .....	<b>25</b>
Section 1 Protection of Control Stations Outside Machinery Space .....	25
Section 3 Draft Stops .....	25
<b>CHAPTER 7 CONTAINMENT OF FIRE</b> .....	<b>27</b>
Section 1 Thermal and Structural Boundaries .....	27
Section 2 Penetration in Fire-resisting Divisions and Prevention of Heat Transmission .....	33
Section 3 Protection of Openings in Fire-resisting Divisions .....	34
Section 5 Protection of Cargo Space Boundaries .....	35
Section 6 Ventilation Systems .....	35
<b>CHAPTER 8 FIRE FIGHTING</b> .....	<b>39</b>
Section 1 Water Supply System .....	39
Section 2 Portable Fire Extinguisher .....	45

Section 3	Fixed Fire-extinguishing Systems .....	48
Section 4	Fire Extinguishing Arrangements In Machinery Spaces .....	50
Section 5	Fire-extinguishing Arrangements In Control Stations, Accommodation and Service Spaces .....	54
Section 6	Fire-extinguishing Arrangements In Cargo Spaces .....	54
Section 7	Cargo Tank Protection .....	55
Section 8	Protection of Cargo Pump Room .....	56
Section 9	Fire-fighter's Outfit .....	56
<b>CHAPTER 9</b>	<b>STRUCTURAL INTEGRITY .....</b>	<b>57</b>
Section 1	Material .....	57
Section 2	Structure of aluminium alloy .....	57
Section 3	Machinery Spaces of Category A .....	57
Section 4	Materials of Overboard Fittings .....	57
Section 5	Protection of Cargo Tank Structure Against Pressure Or Vacuum In Tankers .....	58
<b>CHAPTER 10</b>	<b>ESCAPE .....</b>	<b>61</b>
Section 2	Means of escape .....	61
<b>CHAPTER 11</b>	<b>HELICOPTER FACILITIES .....</b>	<b>69</b>
Section 1	Application .....	69
Section 4	Fire-fighting Appliances .....	69
<b>CHAPTER 12</b>	<b>CARRIAGE OF DANGEROUS GOODS .....</b>	<b>71</b>
Section 1	General Requirements .....	71
Section 2	Special Requirements .....	71
Section 3	Document of compliance .....	75
<b>CHAPTER 13</b>	<b>PROTECTION OF VEHICLE, SPECIAL CATEGORY AND RO-RO SPACES .....</b>	<b>77</b>
Section 1	General Requirements .....	77
Section 2	Precaution against ignition of flammable vapours in closed vehicle spaces closed ro-ro spaces and special category spaces .....	77
Section 3	Detection and alarm .....	79
Section 5	Fire-extinction .....	79
<b>&lt;ANNEX&gt;</b>		
Annex 8-1	Fire Protection Materials .....	81
Annex 8-2	Penetrations through Divisions .....	85
Annex 8-3	Special Requirements for Ships which are not engaged in international voyage or Ships of less than 500 gross tonnage (Fire-fighting system of ships which are subject to Ships Safety	



Law of the Korean Government, but not SOLAS, shall follow the relevant requirements)	90
Annex 8-4 Alleviation Requirements for Fishing Vessels	99
Annex 8-5 Inert Gas Systems	101
Annex 8-6 Other Operation Requirements, etc.	109
Annex 8-7 Safe Return to Port System on Passenger Ships	113
Annex 8-8 Qualitative Failure Analysis for Propulsion and Steering on Passenger Ships - 〈Void〉	116
Annex 8-9 Special Requirements of Fire Protection and Fire Extinction for Cargo Ships	117

## CHAPTER 1 GENERAL

### Section 1 General

#### 101. Application **[See Rule]**

1. In applying **101. 1** of the Rules, "the guidance specified separately" means that the following requirements should be complied with ;
  - (1) Ships of less than 500 tons gross tonnage may be mitigated in accordance with **Annex 8-3** special requirements of the Guidance.
  - (2) Ships which are not engaged in international voyage, and Ships for restricted service (Classification Equipment Notation "C" or "S") may be mitigated in accordance with **Annex 8-3** special requirements of the Guidance.
  - (3) Fishing vessels may be mitigated in accordance with **Annex 8-4** alleviation requirements of the Guidance.
2. Where the Government the flag of which a ship is to be entitled to fly does not authorize this Society to carry out the statutory inspection on behalf of it, the requirements of fire-fighting systems may not be applied.
3. In addition to the requirements of the Rules, the following shall be complied with. *(2020)*
  - (1) In applying **101.4 (2) (B)** of the Rules, "the guidelines developed by IMO" means MSC.1/Circ.1312 and Corr.1. *(2020)*
  - (2) In applying **101. 4 (2) (C)** of the Rules, refer to the Information on flashpoint and recommended fire-fighting media for chemicals to which neither the IBC nor BCH Codes apply. *(MSC/Circ.553)*
  - (3) In applying **101. 4 (5)** of the Rules, "the guidelines developed by IMO" means MSC/Circ.353 as amended by MSC/Circ.387.
4. In addition to the requirements of the Rules, cargo ships wishing to be assigned an AFP(Additional Fire Protection and Fire Extinction) notation as an additional special feature are also to comply with the requirements of **Annex 8-9**. *(2021)*

#### 102. Plans and documents

1. In applying **102. 1 (3)** of the Rules, where the Fixed local application fire-fighting systems is intended for inspection by this Society, the following plans and documents shall be submitted for approval. **[See Rule]**
  - (1) Diagrams of piping and instrument.
  - (2) Diagrams of control system.
  - (3) Piping arrangements and hydraulic calculation sheets.
  - (4) Plans for pump including performance curve.
  - (5) Specifications of location and dimension on the protected area.
  - (6) Others considered necessary by this Society.
2. In applying **102. 1 (4)** of the Rules, where inert gas system is intended for inspection by this Society, the following plans and documents shall be submitted for approval. Where, however, the system is the one already approved by the Society, they may be omitted from submission.**[See Rule]**
  - (1) Plans
    - (a) General arrangements of inert gas systems including the control systems and monitoring systems.
    - (b) Details of each component consisting of inert gas systems.
    - (c) Piping diagram system for the distribution of inert gas.
    - (d) Other plans and documents considered necessary by the Society.
  - (2) Documents
    - (a) Instructions and operation manual of the inert gas system(including the notice related to the safety of the operators).
    - (b) Other drawings and data considered necessary by the Society.
  - (3) The instructions and operation manual specified in (2) (a) are to be carried on board the ship.

### 103. Definitions

1. In applying **103. 1** of the Rules, pantries containing no cooking appliances may contain the following devices. However, a dining room containing such appliances is not to be regarded as a pantry.
  - (1) toasters, microwave ovens, induction heaters and similar appliances each of them with a maximum power of 5 kW; and
  - (2) Electrically heated cooking plates and hot plates for keeping food warm each of them with a maximum power of 2 kW and a surface temperature not above 150 °C. **【See Rule】**
2. In applying **103. 2** (1) and (2) of the Rules, "light-weight constructions" (honeycomb type, etc.) of steel or equivalent material may be used as non load-bearing internal "A" class division in accommodation and service spaces provided they have successfully passed the relevant standard fire test according to the FTP Code. These "light-weight constructions" should not be used as an integral part of main fire zone bulkheads and stairway enclosures on passenger ships. **【See Rule】**
3. In applying **103. 9** (9) of the Rules, the communication systems here mean only internal communication systems, which are required by the rules. **【See Rule】**
4. In applying **103. 10** of the Rules, adhesives used in the construction of the "C" class divisions are not required to be non-combustible; however, they are to have low flame-spread characteristics. **【See Rule】**
5. In applying **103. 18** of the Rules, the following are to be included. (2022) **【See Rule】**
  - (1) Main navigational equipment includes, in particular, the steering stand and the compass, radar and direction-finding equipment.
  - (2) Steering gear rooms containing an emergency steering position are not considered to be control stations.
  - (3) Where in the regulations of this Part relevant to fixed fire-extinguishing systems there are no specific requirements for the centralization within a control station of major components of a system, such major components may be placed in spaces which are not considered to be a control station.
  - (4) Spaces containing, for instance, the following battery sources should be regarded as control stations regardless of the battery capacity:
    - (A) Emergency batteries in separate battery room for power supply from black-out until start of emergency generator;
    - (B) Emergency batteries in separate battery room as reserve source of energy to radio telegraph installation;
    - (C) Batteries for start of emergency generator; and
    - (D) In principle, all emergency batteries required in pursuance of the related provisions of **Pt 6, Ch 1** to the Rules.
6. In applying **103. 28** of the Rules, The weight of mediums on board for the fixed fire-fighting systems (e.g. freshwater, CO<sub>2</sub>, dry chemical powder, foam concentrate, etc.) is to be included in the lightweight and lightship condition.(2018) **【See Rule】**
7. In applying **103. 34** of the Rules, "Oil fuel unit" includes any equipment used for the preparation and delivery of oil fuel for inert gas generators or turbines. Oil fuel transfer pumps are not considered as oil fuel units. **【See Rule】**
8. In applying **103. 41** of the Rules, "Spaces not normally subdivided in any way" means those spaces which are not subdivided in longitudinal direction by watertight bulkheads or gastight bulkheads. **【See Rule】**
9. In applying **103. 45** of the Rules, pantries containing cooking appliances and galleys may contain the following devices. However, any electrically heated cooking plate or hot plate for keeping food warm with a power of more than 5 kW are to be regarded as galleys. **【See Rule】**
  - (1) toasters, microwave ovens, induction heaters and similar appliances each of them with a power of more than 5 kW; and
  - (2) Electrically heated cooking plates and hot plates for keeping food warm each of them with a maximum power of 5 kW.
10. In applying **103. 48** of the Rules, the following requirements for tankers are to be applied. **【See Rule】**
  - (1) Requirements for tankers in this chapter shall apply to tankers carrying crude oil or petroleum

products having a flashpoint not exceeding 60 °C (closed cup test), as determined by an approved flashpoint apparatus, and a Reid vapour pressure which is below the atmospheric pressure or other liquid products having a similar fire hazard.

11. In applying **103. 49** of the Rules, "vehicle spaces" means those cargo spaces other than ro/ro spaces. **【See Rule】**
12. In applying **103. 56** of the Rules, The definition of vehicle carrier is intended for pure car and truck carriers, and should exclude other types of ro-ro cargo ships or container/ro-ro ships, even when carrying empty cars and empty cars and trucks as cargo. (2018) **【See Rule】** ↕

## CHAPTER 2 PROBABILITY OF IGNITION

### Section 1 Arrangements for Oil Fuel, Lubrication Oil and Other Flammable Oils

#### 101. Limitations in the use of oils as fuel

1. In applying **101. 4** of the Rules, machineries and piping systems for the usage of fuel oil having a flashpoint of 43°C or less should comply with the following: **[See Rule]**
  - (1) provisions for the measurement of oil temperature should be provided on the suction pipe of oil fuel pump;
  - (2) stop valves and/or cocks should be provided to the inlet side and outlet side of the oil fuel strainers; and
  - (3) pipe joints of welded construction or of circular cone type or spherical type union joint should be applied as much as possible.
2. Requirements concerning use of crude oil or slop as fuel for tanker boilers are to be in accordance with **Pt 7 Annex 7-1**.

#### 102. Arrangements for oil fuel

1. In applying **102. 3** of the Rules, fuel oil tanks are to comply with **Pt 5, Ch 6, 901. 11. (1) (A)** of the Rules.
2. In applying **102. 3 (1)** of the Rules, when the ship of 400 tons gross tonnage and above is applied to the MARPOL convention, oil shall not be carried in a forepeak tank or a tank forward of the collision bulkhead.
3. In applying **102. 3 (2)** of the Rules, the one shown in **Fig 8.2.1** of the Guidance is to be referred to as the standard arrangement of fuel oil tanks in machinery spaces of category A. And "free standing oil tanks" are to be kept to a minimum.
4. In applying **102. 3 (4)** and **103. 2** of the Rules, when a filling pipes for fuel oil tank or lubricating oil tank are fitted at the place of the tank top nearby or above the overflow pipes, it is considered that there is no worry about the leakage arising from the damages. Pneumatic remote shut-down devices (of the type that requires compressed air only at the time of closing) of fuel oil tanks and lubricating oil tanks are to comply with the following requirements:
  - (1) an exclusive air bottle for remote shut-down is to be provided in an easily accessible position outside the compartment in which fuel oil tanks and lubricating oil tanks are situated.
  - (2) The capacity of air bottle is to be sufficient for closing all the main suction valves of fuel oil tanks at least twice.
  - (3) The air bottle is to be provided with a pressure measuring device at a position which can be easily seen from the position where the remote shut-down device is operated.
  - (4) Air pipes from the air bottle to the main suction valve's actuators are not to be provided with valves except for valves for remote control and blow-off valves for these pipes.
  - (5) Air pipes from the air bottle to the main suction valve's actuators are to be steel or copper pipes.
  - (6) Air charging pipes to the air bottle are to be provided with non-return valves.
  - (7) In case where air bottle are used commonly for remote opening of the sea water suction valve of the emergency fire pump, remote shut-down of dampers for the ventilating fans for machinery spaces, etc, the following requirements are to be complied with:
    - (A) the capacity of the air bottle is to be capable of operating simultaneously all remote controls belonging to at least for twice
    - (B) the air piping for the remote shut-down of the fuel oil tank and the lubricating oil tank is to be arranged separately from piping for other purposes, and the air outlet valve from the air bottle is to be fitted with a name tag for clear identification of the intended service.
5. In applying **102. 3 (4)** of the Rules, s separate location does not mean a separate space.
6. In applying **102. 3 (5)** of the Rules, short sounding pipes may be used for tanks other than double

bottom tanks without the additional closed level gauge provided an overflow system is fitted. And level switches may be used below the tank top provided they are contained in a steel enclosure or other enclosure not capable of being destroyed by fire. In application to 102. 3 (5) (B) of the Rules, ships engaged on domestic voyage only are to be in accordance with Annex 8-3, 1 (3) (E) of the Guidance. **【See Rule】**

7. In applying 102. 4 and 103. 1 of the Rules, air pipes from oil fuel tanks or heated lubricating oil tanks should be led to a safe position on the open deck. They should not terminate in any place where a risk of ignition is present. Air pipes from unheated lubricating oil (including hydraulic oil) tanks may terminate in the machinery space, provided that the open ends are so situated that issuing oil cannot come into contact with electrical equipment or heated surfaces. **【See Rule】**
8. In applying 102. 5 of the Rules, high pressure means having pressures of 10 MPa or above. (2020) **【See Rule】**
9. In applying 102. 5 (1) of the Rules, hose clamps and similar types of attachments for flexible pipes should not be permitted. **【See Rule】**
10. In applying 102. 5 (2) of the Rules, engines having single cylinder, multi-cylinder engines having separate fuel pumps and those having multiple fuel injection pump units are included, however, this regulation do not apply to gas turbine and lifeboat engines. Ships engaged on domestic voyage only are to be in accordance with Annex 8-3, 1. (3) (C) of the Guidance. **【See Rule】**

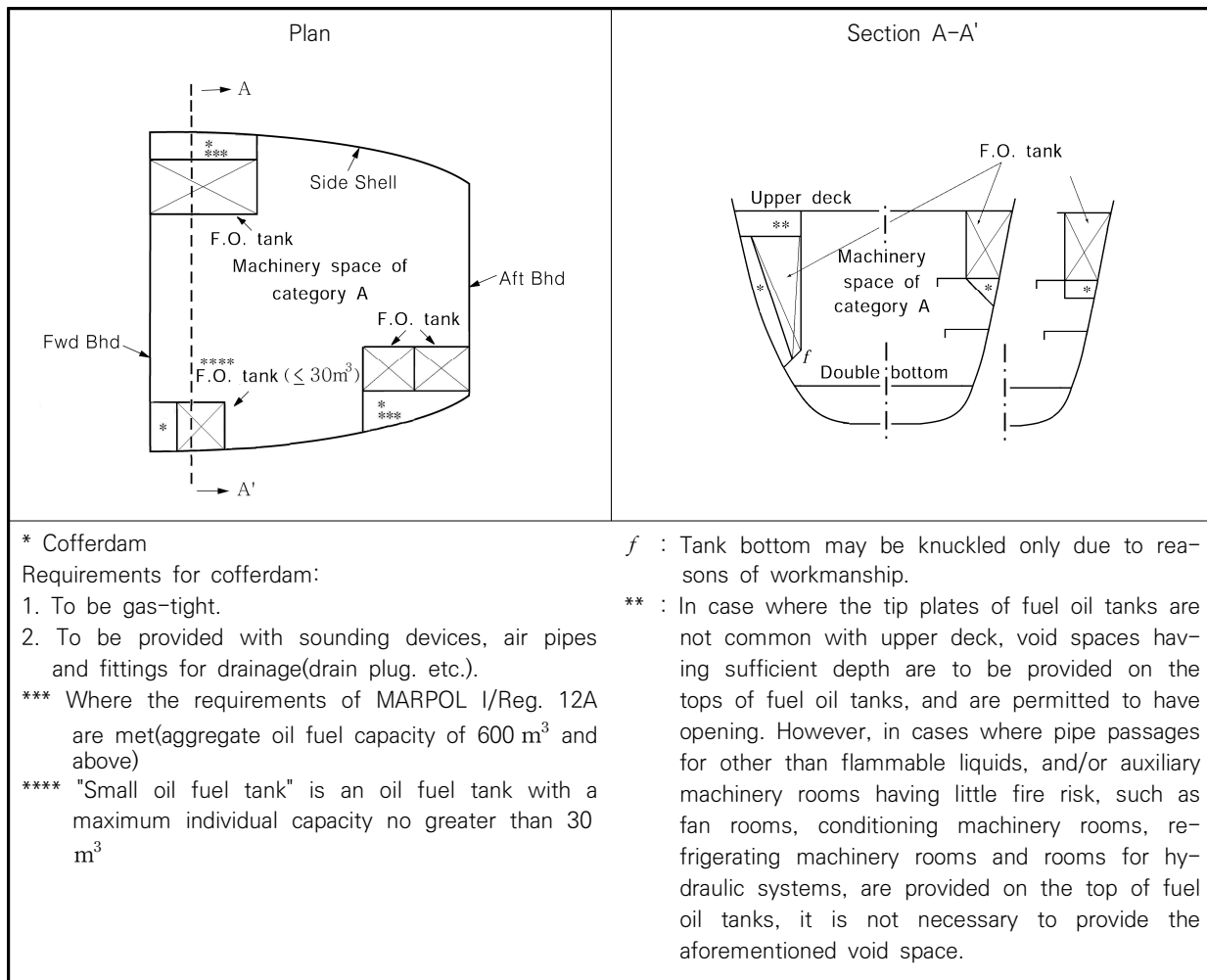

Fig 8.2.1 Standard arrangement of fuel oil tanks in machinery spaces of category A

11. In application to the **102.5~104.** of the Rules, where any one of following is fulfilled, The use of materials other than steel is considered acceptable by the Society. (2017)
- (1) Internal pipes which cannot cause any release of flammable fluid onto the machinery or into the machinery space in case of failure
  - (2) Components that are only subject to liquid spray on the inside when the machinery is running, such as machinery covers, rocker box covers, camshaft end covers, inspection plates and sump tanks. It is a condition that the pressure inside these components and all the elements contained therein is less than 0.18 N/mm<sup>2</sup> and that wet sumps have a volume not exceeding 100 litres
  - (3) Components attached to machinery which satisfy fire test criteria according to standard ISO 19921/19922 or other standards acceptable to the Society, and which retain mechanical properties adequate for the intended installation. (2021)

**104. Arrangements for other flammable oils [See Rule]**

This requirement is not applicable to hydraulic valves and cylinders located on weather decks, in tanks, cofferdams, or void spaces.

## Section 2 Arrangements for Gaseous Fuel for Domestic Purpose

**201. Arrangements for gaseous fuel for domestic purpose [See Rule]**

A portion of open deck, recessed into a deck structure, machinery casing, deck house, etc., utilized for the exclusive storage of gas bottles is considered acceptable, provided that such a recess has an unobstructed opening, except for small appurtenant structures, such as opening corner radii, small sills, pillars, etc.(The opening may be provided with grating walls and door) and the depth of such a recess is not greater than 1 m. A portion of open deck meeting the above should be considered as open deck in applying **Ch 7, Sec 1 tables 8.7.1 to 8.7.8** of the Rules.

## Section 3 Miscellaneous Items of Ignition Sources and Ignitability

**301. Electric radiators [See Rule]**

Reference is made to IEC 60092-Electrical installations in ships.

**302. Waste receptacles [See Rule]**

This regulation is not intended to preclude the use of containers constructed of combustible materials in galleys, pantries, bars, garbage handling or storage spaces and incinerator rooms provided they are intended purely for the carriage of wet waste, glass bottles and metal cans and are suitably marked.

**303. Insulation surfaces protected against oil penetration [See Rule]**

"Spaces where penetration of oil products is possible" means the spaces located in the vicinity of all types of equipment(purifiers, pumps and tanks) and pipe fittings(valves, flanges, strainers, flow-meters, etc.), handling oils(fuel oil, lubricating oil, hydraulic oil and thermal oil) with possible involvement of oils or oil vapours leaked or splashed during operation or in maintenance work to reach out thermal insulation. However, these do not apply to thermal insulation of pipes in machinery spaces. The fire insulation in such spaces can be covered by metal sheets(not perforated) or by vapour-proof glass cloth accurately sealed at the joint.

## Section 4 Cargo Areas of Tankers

### 401. Separation of cargo oil tanks

1. In applying **401. 1** of the Rules, "cofferdam" mean, for the purpose of this regulation, an isolating space between two adjacent steel bulkheads or decks. The minimum distance between the two bulkheads or decks should be sufficient for safe access and inspection. In order to meet the single failure principle, in the particular case when a corner-to-corner situation occurs, this principle may be met by welding a diagonal plate across the corner. No cargo, wastes or other goods should be contained in cofferdams. And ballast pump rooms are also to comply with **Pt 7, Ch 1, 1004.** of the Rules and then the lower part of the ballast pump rooms may be recessed into machinery space of category A to the same extent as provided for cargo pump rooms.

Void spaces or ballast water tank protecting fuel oil tank as shown in **Fig 8.2.2** of the Guidance, need not be considered as "cargo area" defined in **Ch 1, 103. 6** of the Rules even though they have a cruciform contact with the cargo oil tank or slop tank.

The void space protecting fuel oil tank is not considered as a cofferdam specified in this paragraph. There is no objection to the locations of the void space shown in **Fig 8.2.2** of the Guidance, even though they have a cruciform contact with the slop tank. **[See Rule]**

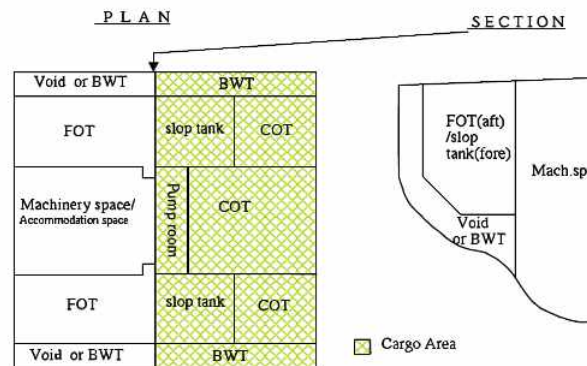

Fig 8.2.2 Separation of cargo oil tanks

2. In applying **401. 2** of the Rules, arrangement of main cargo control stations, control stations, accommodation spaces and service spaces is to comply with the following requirements: **[See Rule]**
  - (1) Main cargo control stations, control stations, accommodation spaces and service spaces (including chain lockers) are not to make point contact or linear contact with cargo oil tanks or slop tanks.
  - (2) Main cargo control stations, control stations, accommodation spaces and service spaces need not be arranged aft of the recess of the lower parts of cargo pump rooms and ballast pump rooms into machinery spaces of category A accepted under the requirements of **401. 1** of the Rules and aft of the oil fuel tanks or ballast tanks (see **Fig 8.2.3** of the Guidance).
3. In applying **401. 3** of the Rules, lamp rooms, store rooms, paint rooms, lockers, etc. independently provided at the bow section which are seldom accessed by persons may be provided in cargo areas other than cargo tanks and slop tanks such as the upper part of the ballast tanks, cofferdams, etc. or ship side adjoining thereto. (see **Fig 8.2.4** of the Guidance). **[See Rule]**
4. In applying **401. 2 & 3** of the Rules, Paint lockers, regardless of their use, cannot be located above the tanks and spaces defined in **2** for oil tankers and the cargo area for chemical tankers.
5. In applying **401. 4 (1)** of the Rules, the arrangements and separation of spaces in combination carriers are to comply with the requirements for ore/oil carriers specified in **Pt 7, Ch 2, 206.** and **207.** of the Rules, and the requirements of **Pt 7, Ch 3, Sec 15** of the Rules for bulk/oil carriers. **[See Rule]**
6. In applying **401. 6** of the Rules, "a permanent continuous coaming" means a suitable place between the aft extreme end of cargo oil tanks and the front bulkheads of deckhouses and it is not to be made lower than 50 mm above the upper edge of shear strakes (see **Fig 8.2.5** of the Guidance). And



special consideration for stern loading means that foam extinguishers or equivalent are to be provided in addition to the requirements of Pt 7, Ch 1, 1002. 4 (4) and 1006. of the Rules, and further, oil drip pans in sufficient size or spillage coaming are to be provided. **[See Rule]**

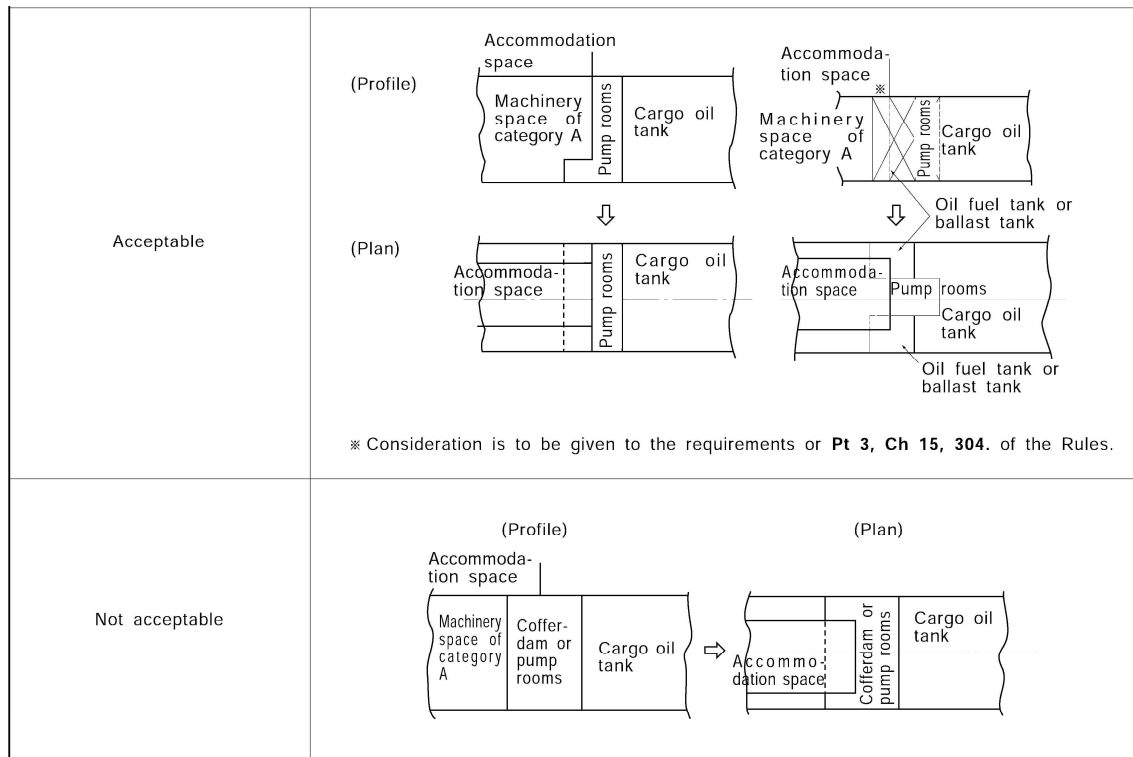

Fig 8.2.3 Arrangements of accommodation spaces, cargo oil tanks and machinery spaces of category A

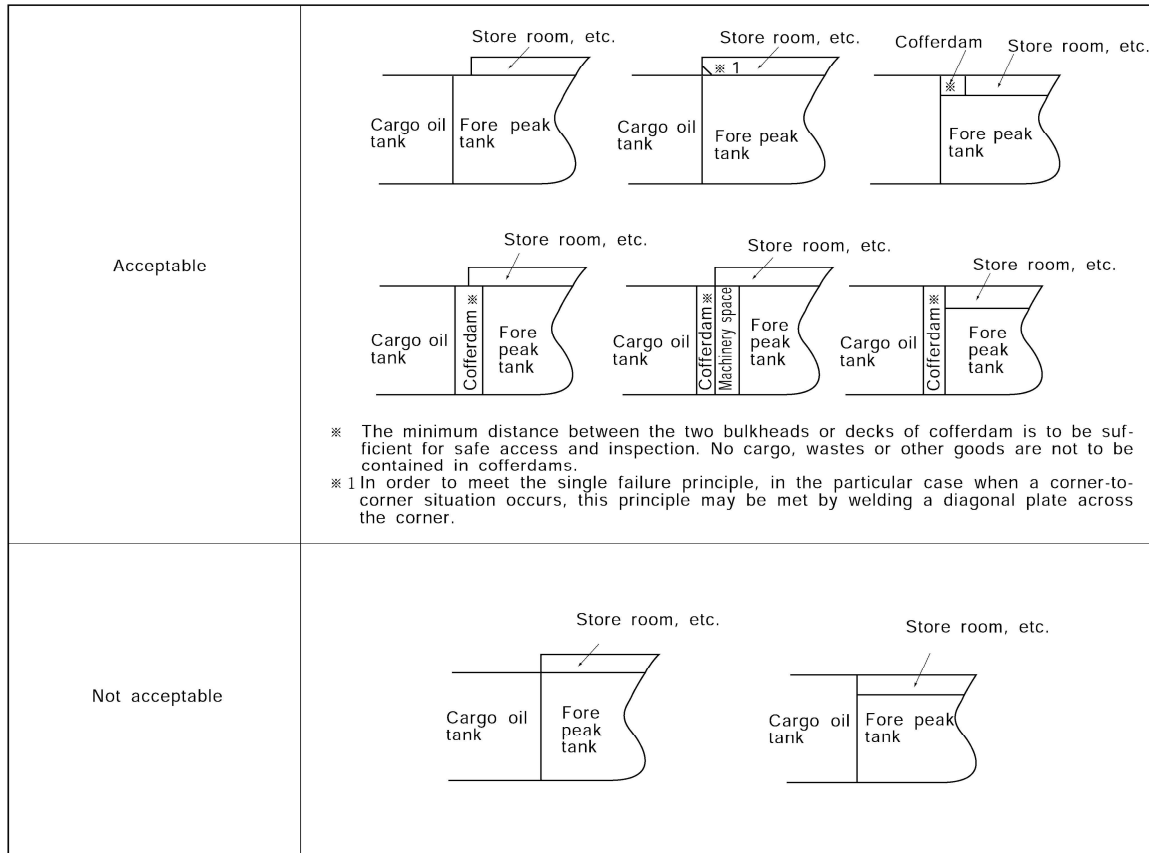

Fig 8.2.4 Arrangements of lamp rooms, store rooms, paint rooms, lockers, etc.

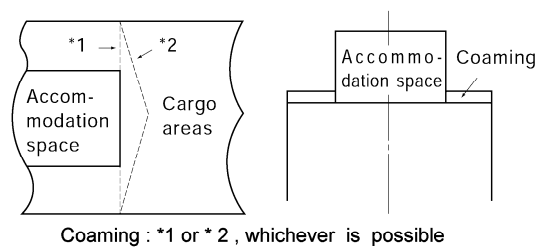

Fig. 8.2.5 Coaming preventing spill into accommodation spaces and service saces

7. Arrangement of fuel tanks in cargo area on oil and chemical tankers, carrying liquid cargoes having a flashpoint not exceeding 60°C and/or toxic liquid cargoes is to comply with the following requirements: (2019)

- (1) Fuel tanks located with a common boundary to cargo or slop tanks are not be situated within nor extend partly into the cargo tank block. Such tanks may, however, be situated aft and/or forward of the cargo tank block. Cargo tank block is the part of the ship extending from the aft bulkhead of the aftmost cargo or slop tank to the forward bulkhead of the forward most cargo or slop tank, extending to the full depth and beam of the ship, but not including the area above the deck of the cargo or slop tank shown in Fig 8.2.6.

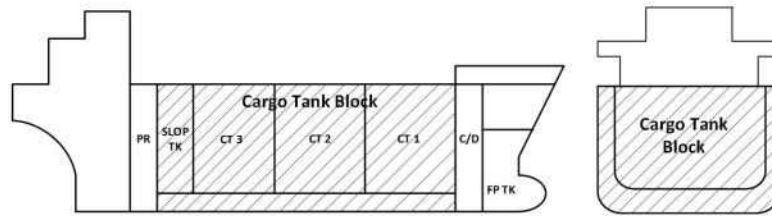

Fig. 8.2.6 Cargo tank block

- (2) They may be accepted when located as independent tanks on open deck in the cargo area subject to spill and fire safety considerations.
- (3) The arrangement of independent fuel tanks and associated fuel piping systems, including the pumps, can be as for fuel tanks and associated fuel piping systems located in the machinery spaces. For electrical equipment, requirements to hazardous area classification must however be met.
- (4) For the purpose of this regulation, toxic liquid cargoes include those for which toxic vapour detection is specified in column "k" of the table of **Pt 7 Annex 7B-1**.

#### 402. Restriction on boundary openings

1. Owing to the design of a ship, where it is impossible or impractical to satisfy the requirements specified in **402. 1** of the Rules, access doors, air inlets and opening facing cargo areas may be provided subject to no sources of ignition in a hazardous areas as defined in **Pt 7, Ch 1, 1101. 2**. In such cases, explosion-protected electrical equipment complying with IEC 60092-502:1999 is not regarded as a source of ignition. In application of **402. 1** of the Rules, access to forecabin spaces containing sources of ignition may be permitted through doors facing the cargo area, provided the doors are located outside hazardous areas as defined in IEC 60092-502:1999. (2024) **[See Rule]**
2. In applying **402. 2** of the Rules, the boundaries of spaces, where application of "A-60" class insulation is required, are to be insulated as exemplified in **Fig 8.2.7** of the Guidance. The ceilings and floors of spaces with asterisk are also to be applied with "A-60" class insulation. Incidentally, foam liquid tanks for the deck foam systems may be provided in these spaces. (2019)

With respect to **402. 2** of the Rules, an access to a deck foam system room (including the foam tank and the control station) may be permitted within the limits mentioned in **402. 2** of the Rules, provided that the conditions specified in **402. 1** of the Rules are satisfied and that door is located flush with the bulkhead. (2019)

And wheelhouse doors and wheelhouse windows which can be made rapidly and efficiently gas and vapour tight are to be such doors and windows that are provided with packing and clamping fittings, and are to be tested for gas tightness. Where hose tests are adopted instead of gas tightness, the following hose tests are to be carried out. **[See Rule]**

- (1) Nozzle diameter is to be minimum 12 mm.
- (2) Water pressure just before the nozzle is to be not less than 2 bar.
- (3) Distance between the nozzle and the doors or windows is to be maximum 1.5 m.

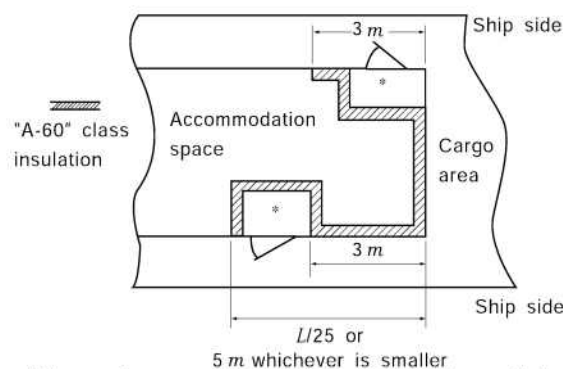

\* The ceilings and floors of spaces with asterisk are also to be applied with "A-60" class insulation.

Fig. 8.2.7 A-60 class insulation to be required

3. In applying 402. 4 of the Rules, the Pipe ducts in double bottom under cargo oil tanks shall comply with the following requirements.
  - (1) They should not communicate with the engine room.
  - (2) Provision shall be made for at least two exits to the open deck arranged at a maximum distance from each other. One of these exits fitted with a watertight closure may lead to the cargo pump room.
  - (3) In the duct, provision shall be made for adequate mechanical ventilation. **【See Rule】**

### 403. Cargo tank venting

1. In applying 403. 2 (2) of the Rules, where the arrangements are in common combined with other cargo oil tanks, the arrangement and method in order to isolate each cargo oil tank are to be as follows. (See Fig 8.2.8 of the Guidance) **【See Rule】**
  - (1) It is to be install the stop valve etc. to isolate each cargo oil tank in order to prevent fire and explosion in specific cargo oil tank from spreading other cargo oil tank pass through vent system.
  - (2) Stop valve is to be closed except loading and unloading and fitted in a locks in order not to mistaken operation and managed by responsible person.
  - (3) Even though stop valves are closed, PV valves are to installed with bypassing type for the stop valve in cargo tanks for the capable of controlling of a change of pressure occurring by a change of temperature at sea. In this case, where the cargo tank has a negative pressure, PV valves are to be constructed with the independent suction valves which are able to inhale the air form the outside.

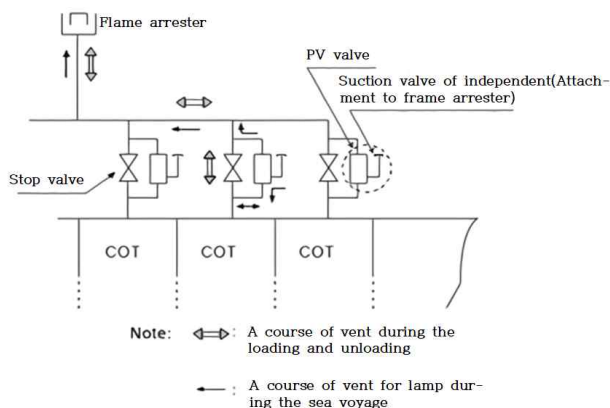

Fig. 8.2.8 Examples of isolation of cargo oil tank

2. In applying 403. 3 of the Rules, refer to MSC/Circ.677(including amendments in accordance with MSC/Circ.1009 and MSC.1/Circ.1324 & 1325) on revised standards for the design, testing and locating of devices to prevent the passage of flame into cargo tanks in tankers MSC/Circ.450/Rev.1 on revised factors to be taken into consideration when designing cargo tank venting and gas-freeing arrangements. And ullage openings do not include cargo tank openings that are fitted with standpipe arrangements with its own manually operated shutoff valve. Examples include the common 1" to 2" diameter standpipe arrangements that are used for sampling, monitoring or measuring of ullage/temperature/interface, oxygen, liquid and hand dipping in the cargo tank. And ullage plugs, sighting ports and tank cleaning openings are not to be arranged in enclosed spaces.

And then the designs, arrangements, tests of devices to prevent the passage of flame are to be in accordance with followings. The devices are to be type approved by this Society. **【See Rule】**

- (1) The venting system is to be provided with devices to prevent the passage of flame into the cargo oil tanks.
  - (A) Flame screens, flame arresters or detonation flame arrester are to be fitted at the following openings.
    - (a) Air suction inlets, through which vapours cannot be vented to atmosphere, of the venting system for preventing the vacuum in the tanks specified Ch 9, 501. 1 of the Rules.

- (b) Air suction inlets, through which vapours cannot be vented to atmosphere, of the venting systems for preventing the vacuum in the tank specified in **Ch 9, 501. 2** of the Rules.
- (B) Flame arrester, detonation flame arresters or high velocity vents are to be fitted for the following openings.
  - (a) Openings for pressure release specified in **Ch 9, 502.**, of the Rules.
  - (b) Vent outlets specified in **Ch 2, 403. 4** (1) (C) of the Rules.
  - (c) Discharge outlets specified in **Ch 2, 406. 3** (2) of the Rules.
- (C) For the vent outlets specified in **Ch 2, 403. 4** (1) (D) of the Rules, the high velocity device is to be fitted.
- (2) For determining the size of the devices to avoid pressure exceeding allowable one of vacuum in cargo tanks during loading of discharging calculations of pressure losses are to be carried out. The following parameters are to be taken into account.
  - (A) Loading/discharging rates
  - (B) Gas release
  - (C) Pressure loss across the devices, taking into account the resistance coefficient
  - (D) Pressure loss in the venting system
  - (E) Pressure at which the vent opens if a high velocity device is used
  - (F) Density of the mixture of the saturated vapour and air
- (3) Tests and inspection
  - (A) The tests and inspection for the individual product are to be carried out in accordance with followings.
    - (a) Construction inspection
    - (b) Hydraulic test(only for high velocity valves)
    - (c) Confirmation of the pressure at which the valve opens and closes
  - (B) On board test  
It is to be ascertained by a suitable method that the high velocity valves can be operable smoothly after installed on board.
- (4) Test report  
A test report for each finished device is to be prepared. This is to include
  - (A) detailed drawings of the device
  - (B) types of tests conducted. Where in-line devices are tested, this information is to include the maximum pressures and velocities observed in the test
  - (C) specific advice on approved attachments
  - (D) types of cargo for which the device is approved drawings of the test rig
  - (E) in the case of high velocity vent, the pressures at which the device opens and closes in the efflux velocity
  - (F) all the information marked on the device in following (6)
- (5) Manufacturer's instruction manual  
The manufacturer is to supply a copy of the instruction manual, which is to be kept on board the tanker and which is to include followings.
  - (A) installation instructions
  - (B) operating instructions
  - (C) maintenance requirements, including cleaning
  - (D) copy of the laboratory report referred to in (8)
  - (E) flow test data, including flow rates under both positive and negative pressures, operating sensitivity, flow resistance and velocity, are to be provided.
- (6) Marking of device  
Each device is to be permanently marked, or have a permanently fixed tag made of stainless steel or other corrosion-resistant material, to indicate
  - (A) manufacturer's name or trade mark
  - (B) style, type, model or other manufacturer's designation for the device
  - (C) size of the outlet for which the device is approved
  - (D) approved location for installation, including maximum or minimum length of pipe, if any, between the device and the atmosphere
  - (E) direction of flow through the device
  - (F) apparatus group assigned to the tested device  
(Ex: IIA, IIB, IIC, etc.)
  - (G) indication of the test laboratory and report number
  - (H) compliance with the requirements of MSC/Circ.677

(including amendments in accordance with MSC/Circ.1009 and MSC.1/Circ.1324 & 1325)

3. In applying **403. 4 (1) (C) and (D)** of the Rules, electrical equipment fitted in compliance with **IEC 60092-502:1999** is not considered a source of ignition or ignition hazard. **(2022) [See Rule]**
4. In applying "not less than 10m measured horizontally from the nearest air intakes and openings to enclosed spaces containing a source of ignition and from deck machinery, which may include anchor windlass and chain locker openings, and equipment which may constitute an ignition hazard" specified in **403. 4 (1) (C)** of the Rules, Area Classification is to be carried out in accordance with the principles laid down in IEC 60092-502:1999 and the classes of hazardous areas are to be referred to **Pt 7, Ch 1, 1101. 2** of the Rules. **(2023) [See Rule]**
  - (1) Areas on open deck, or semi-enclosed spaces on open deck, within a vertical cylinder of unlimited height and 6m radius centred upon the centre of the outlet, and within a hemisphere of 6m radius below the outlet which permit the flow of large volumes of vapour, or gas mixtures during loading/discharging/ballasting are defined as **Zone 1** as specified by **IEC 60092-502:1999 para 4.2.2.8**.
  - (2) Areas within 4m beyond the zone specified in (1) above are defined as **Zone 2** as specified by **IEC 60092-502:1999 para 4.2.3.2**.
  - (3) Electrical equipment or cables shall not normally be installed in hazardous areas. Where essential for operational purposes, electrical equipment may be installed in accordance with **IEC 60092-502:1999**.

#### 404. Ventilation

In applying **404. 1** of the Rules, ventilation fan of non-sparking type is to be comply with the requirements specified in **Ch 3, 104.** of the Rules. **[See Rule]**

#### 405. Inert gas systems **[See Rule]**

1. Refer to **Annex 8-5**.
2. In applying **405. 1 (3)** of the Rules, double-hull spaces required to be fitted with suitable connections for the supply of inert gas are all ballast tanks and void spaces of double-hull and double-bottom spaces adjacent to the cargo tanks, including the forepeak tank and any other tanks and spaces under the bulkhead deck adjacent to cargo tanks, except cargo pump-rooms. **(2018)**
3. In applying **405. 3 (2)** of the Rules, "a permanently fitted inert gas distribution system" means that the branch lines for the supply of inert gas into the double hull spaces are to be connected to the position between the inert gas regulating valve and the water seal or equivalent measures.
4. In applying **405. 3 (3)** of the Rules, in case not permanently connected to an inert gas distribution system "appropriate means" means the arrangement consist of portable pipes or flexible hoses and blanking flange.

#### 406. Inerting, purging and gas freeing

1. In applying **406. 2** of the Rules, "the Guidance as provided separated" means **21** of **Annex 8-6**. special requirements of the Guidance. **[See Rule]**
2. In applying **406. 3** of the Rules, the outlets mentioned in (1) (2) (3) are to be located in compliance with **403. 4 (1) (C)** of the Rules as far as the horizontal distance is concerned. **[See Rule]**

#### 407. Gas measurement and detection

1. In applying **407. 1** of the Rules, in case where the portable instruments are provided onboard in accordance with (1) or (2), it is considered as satisfied with the requirements of the Rules for at least one portable instrument for measuring oxygen and one for measuring flammable vapour concentrations, together with a sufficient set of spares:
  - (1) Two(2) instruments, each capable of measuring both oxygen and flammable vapour concentrations
  - (2) Two(2) portable instruments for measuring oxygen and two portable instruments for measuring flammable vapour concentrations.

2. In applying **407. 1** of the Rules, "suitable means are to be provided for the calibration of all such instruments" refers to portable atmosphere testing instruments being calibrated on board or ashore in accordance with the manufacturer's instructions. For the avoidance of any doubt, the above clarification refers to the calibration of portable atmosphere testing instruments, as required by SOLAS regulation XI-1/7, and not to any pre-operational accuracy tests as recommended by the manufacturer. (2019)
3. For tankers fitted with inert gas systems in **407. 1** of the Rules, at least two portable gas detectors are to be capable of measuring concentrations of flammable vapours in inerted atmosphere (% gas by volume). (2021) **[See Rule]**
4. In applying **407. 3** of the Rules, fixed hydrocarbon gas detection systems are to be type approved by the Society and to be designed, constructed and tested to the satisfaction of performance standards(MSC.1/Circ.1370) developed by the IMO.
5. In applying **407. 3** of the Rules, fixed hydrocarbon gas detection systems shall comply with the requirement of Ch 16 of the FSS Code.
6. In applying **407. 3** (1) of the rules, the following requirements are to be applied.
  - (1) "Cargo tanks" in the phrase "spaces adjacent to the cargo tanks" includes slop tanks except those arranged for the storage of oily water only.
  - (2) "Spaces" in the phrase "spaces under the bulkhead deck adjacent to cargo tanks" includes dry compartments such as ballast pump-rooms and bow thruster rooms and any tanks such as freshwater tanks, but excludes fuel oil tanks.
  - (3) "Adjacent" in the phrase "adjacent to the cargo tanks" includes ballast tanks, void spaces, other tanks or compartments located below the bulkhead deck located adjacent to cargo tanks and includes any spaces or tanks located below the bulkhead deck which form a cruciform (corner to corner) contact with the cargo tanks. **[See Rule]**

#### **410. Protection of cargo pump-rooms in Tanker [See Rule]**

1. Pump-rooms intended solely for ballast transfer need not comply with the requirements of **410.** The requirements of **410.** are only applicable to the pump-rooms, regardless of their location, where pumps for cargo, such as cargo pumps, stripping pumps, pumps for slop tanks, pumps for COW or similar pumps are provided. "Similar pumps" includes pumps intended for transfer of fuel oil having a flashpoint less than 60 °C.
2. In applying **410. 2** of the Rules, where the lighting in cargo pump-rooms can be commonly used as the emergency lighting, this lighting should be interlocked with the ventilation systems. However, this interlock should not prevent operation of the emergency lighting in case of the loss of the main source of electrical power. **[See Rule]**
3. In applying **410. 3** of the Rules, a system for continuous monitoring of the concentration of hydrocarbon gases is to be in accordance with the followings: **[See Rule]**
  - (1) The system may be of a sampling type provided that the system is dedicated for cargo pump rooms. In this case a sampling period is to be as short as possible.
  - (2) "Suitable positions in order that potentially dangerous leakages are readily detected" means the zone where air circulation is reduced(e.g. recessed corners).
  - (3) Where a gas analysing units of the sampling type with non-explosion proof measuring equipment may be located in areas outside cargo areas, e.g. in cargo control room, navigation bridge or engine room when mounted on the forward bulkhead provided the following requirements are observed:
    - (A) Sampling lines shall not run through gas safe spaces, except where permitted under 5.
    - (B) The gas sampling pipes shall be equipped with flame arresters. Sample gas is to be led to the atmosphere with outlets arranged in a safe location.
    - (C) Bulkhead penetrations of sample pipes between safe and dangerous areas shall be of approved type and have same fire integrity as the division penetrated. A manual isolating valve shall be fitted in each of the sampling lines at the bulkhead on the gas safe side.
    - (D) The gas detection equipment including sample piping, sample pumps, solenoids, analysing units etc. shall be located in a reasonably gas tight enclosure (e.g. a fully enclosed steel cabinet with a gasketed door) which is to be monitored by its own sampling point. At gas

concentrations above 30% LFL inside the enclosure the entire gas analysing unit is to be automatically shut down.

- (E) Where the enclosure cannot be arranged directly on the bulkhead, sample pipes shall be of steel or other equivalent material and without detachable connections, except for the connection points for isolating valves at the bulkhead and analysing units, and are to be routed on their shortest ways. ↓



## CHAPTER 3 FIRE GROWTH POTENTIAL

### Section 1 Control of Air Supply and Flammable Liquid to The Spaces

#### 101. Closing appliances and stopping devices of ventilation

1. In applying **101. 1** of the Rules, it need not comply with the requirement of details of duct penetrations specified **Ch 7, 603.** of the Rules.
2. In applying **101. 1** of the Rules, Battery room ventilators are to be fitted with a means of closing for conditions of following (1) to (3). And where a battery room ventilator is fitted with a closing device, then a warning notice stating, for example "This closing device is to be kept open and only closed in the event of fire or other emergency - Explosive gas", is to be provided at the closing device to mitigate the possibility of inadvertent closing.
  - (1) The battery room does not open directly onto an exposed deck.
  - (2) The ventilation opening for the battery room is required to be fitted with a closing device according to the Load Line Convention (i.e. the height of the opening does not extend to more than 4.5 m above the deck for position 1 or to more than 2.3 m above the deck in position 2
  - (3) The battery room is fitted with a fixed gas fire extinguishing system.
3. In applying **101. 1** of the Rules, the following requirements apply to closable ventilation louvers and ventilator closing appliances serving emergency generator rooms, where fitted. (2022)
  - (1) Ventilation louvers and closing appliances may either be hand-operated or power-operated (hydraulic / pneumatic / electric) and are to be operable under a fire condition.
  - (2) Hand-operated ventilation louvers and closing appliances are to be kept open during normal operation of the vessel. Corresponding instruction plates are to be provided at the location where hand-operation is provided.
  - (3) Power-operated ventilation louvers and closing appliances shall be of a fail-to-open type. Closed power-operated ventilation louvers and closing appliances are acceptable during normal operation of the vessel. Power-operated ventilation louvers and closing appliances shall open automatically whenever the emergency generator is starting / in operation. (2022)
  - (4) It shall be possible to close ventilation openings by a manual operation from a clearly marked safe position outside the space where the closing operation can be easily confirmed. The louver status (open/closed) shall be indicated at this position. Such closing shall not be possible from any other remote position. **[See Rule]**
4. In applying **101. 2** of the Rules, the fan in a HVAC temperature control unit, or a circulation fan inside a cabinet/switchboard, is not considered to be a ventilation fan as addressed in **Ch 2 101. 2, 3** and **Ch 5, 701. 3** of the Rules, if it is not capable of supplying outside air to the cabin space when the power ventilation is shut down (e.g., small units intended for re-circulation of air within a cabin). Therefore, such fans need not be capable of being stopped from an easily accessible position (or a safe position) outside the space being served when applying **Ch 2 101. 2** or **3** and need not be capable of being controlled from a continuously manned central control station for passenger ships carrying more than 36 passengers when applying **Ch 5, 701. 3.** **[See Rule]**

#### 103. Additional requirements for means of control in periodically unattended machinery spaces **[See Rule]**

These requirement applies to machinery spaces of category A.

#### 104. Ventilation fan of non-sparking type [See Rule]

1. Notwithstanding the requirements specified above, fans for which non-sparking property test is carried out in the presence of the Surveyor with satisfactory results may be considered as a non-sparking type. This test may be omitted for fans having test results considered as appropriate by the Society.
2. In case where non-metal materials are used, the antistatic property is to be verified by a method as considered adequate by the Society. Those with an electric resistance not exceeding  $1 \times 10^4 \sim 10^8 \Omega$  (British Standard BS 2050) or those with an electrical conductivity of  $1 \times 10^{-10}$  S/m or less may be considered to have antistatic property.

### Section 2 Fire Protection Materials [See Rule]

#### 201. Use of non-combustible materials

In applying **201. 1** of the Rules, grounds, gratings, linings, ceilings, and internal divisions with associated doors used in refrigerated compartments may not be of the non-combustible materials. "cold service systems" means refrigeration systems and chilled water piping for air-conditioning systems, i.e systems with temperatures below ambient air and sea water.

#### 202. Use of combustible materials

1. In accommodation spaces, service spaces and control stations, details of fire protection materials for restricted use of combustible materials are to be in accordance with **Annex 8-1** of the Guidance regardless of the type of material used.
2. A division consisting of a non-combustible core and combustible veneers may be accepted as a B or C class division, provided that the non-combustible core is tested in accordance with the **FTP code part 1**, that the B class division is tested in accordance with the **FTP code, part 3**, and that the veneers are tested in accordance with the **FTP code part 5** and **part 2**, if applicable.
3. In applying **202. 4** of the Rules, "concealed spaces or inaccessible spaces" is, for instance, the spaces in the rear side of ceilings, spaces between lining and shell plating, spaces in double-plated bulkheads and other similar spaces. And "having low flame-spread characteristics" means those combustible materials which passed the following tests in accordance with the requirements specified in the Guidance for **Approval of Manufacturing Process and Type Approval, etc.**
  - (1) Flame propagation test
  - (2) Smoking test
  - (3) Toxic gas test ↴

---

## CHAPTER 4 SMOKE GENERATION POTENTIAL AND TOXICITY

### Section 1 Paints, Varnishes and Other Finishes

#### 101. Paints, vanishes and other finishes [See Rule]

This regulation only applies to accommodation spaces, service spaces, control stations as well as stairway enclosures. "Other finishes" mean combustible flooring of deck covering and combustible veneers applied on surfaces of bulkheads, linings and ceilings. However, those surface materials used for handrails and non-skid strips of stairs or other surface materials used only for equally small areas of application may not be required to satisfy these requirements. And It does not apply to furniture. Vibration damping rubber may be used unless it forms a part of the structural integrity.

### Section 2 Primary Deck Coverings

#### 201. Primary deck coverings [See Rule]

"Primary deck coverings" means the first combustible layer of a floor construction which is applied directly on the top of deck plating and is inclusive of any primary coat, anti-corrosive compound or adhesive which is necessary to provide protection or adhesion to the deck plating. In this case, "the first layer" means the materials forming deck covering excluding "A" class deck (including insulation materials), non-combustible materials and fire retardant surface floorings. Finishes such as plastic tile and latex used as primary deck covering are also to comply with **FTP Code**. ↴

## CHAPTER 5 DETECTION AND ALARM

### Section 1 General

#### 101. General requirements

1. In applying **101. 1** of the Rules, fixed fire detection and fire alarm system are to be type approved by the Society and are also to be complied with the following requirements. **【See Rule】**
  - (1) In applying Ch 9, 2.1.6.4 of the FSS Code, the requirement that a system be so arranged to ensure that any fault occurring in the loop will not render the whole loop ineffective, is considered satisfied when a fault occurring in the loop only renders ineffective a part of the loop not being larger than a section of a system without means of remotely identifying each detector.
  - (2) In applying Ch 9, 2.2.4 of the FSS Code, the '30 minutes' means the last 30 minutes of the periods required under SOLAS Reg. II-1/42 and II-1/43 (18 hours for cargo ships and 36 hours for passenger ships). *(2018)*
  - (3) Power supply to the alarm sounder system when not an integral part of the detection system specified in Ch 9, 2.5.1.1 of the FSS Code.
    - (A) There are to be not less than two sources of power supply for the alarm sounder system used in the operation of the fixed fire detection and fire alarm system, one of which is to be an emergency source of power.
    - (B) In vessels required by SOLAS Reg. II-1/42 and 43 to be provided with a transitional source of emergency electrical power, the alarm sounder system is to be powered from this power source.
  - (4) A space in which a cargo control console is installed, but does not serve as a dedicated cargo control room (e.g. ship's office, machinery control room), is to be regarded as a cargo control room for the purposes of Ch 9, 2.5.1.3 of the FSS Code, as amended by **IMO Res.MSC.339(91)**, and therefore be provided with an additional indicating unit. *(2017)*
  - (5) In applying Ch 9, 2.1.2.4.3 of the FSS Code, watertight doors complying with Reg. II-1/16 which also serve as fire doors are not to close automatically in case of fire detection. *(2022)*
2. In applying **101. 2** of the Rules, Sample extraction smoke detection systems is to be type approved by the Society.
3. In applying **101. 2** of the Rules, if the CO<sub>2</sub> system discharge pipes are used for the sample extraction smoke detection system, the control panel can be located in the CO<sub>2</sub> room provided that an indicating unit is located on the navigation bridge. Such arrangements are considered to satisfy the requirements of the regulation of FSS Code 10.2.4.1.2. Indicating unit has the same meaning as repeater panel and observation of smoke should be made either by electrical means or by visual on repeater panel. **【See Rule】**

### Section 2 Protection of Machinery Spaces

#### 201. Installation

These requirement applies to machinery spaces of category A. **【See Rule】**

#### 202. Design **【See Rule】**

The fire detecting system for unattended machinery spaces shall be complied with the following requirements.

1. An automatic fire detection system is to be fitted in the machinery spaces.
2. The system is to be designed with self-monitoring properties. Power or system failures are to initiate an audible alarm distinguishable from the fire alarm.
3. The fire detection indicating panel is to be located on the navigating bridge, fire control station, or other accessible place where a fire in the machinery space will not render it inoperative.

4. The fire detection indicating panel is to indicate the place of the detected fire in accordance with the arranged fire zones by means of a visual signal. Audible signals clearly distinguishable in character from any other audible signals shall be audible throughout the navigating bridge and the accommodation area of the personnel responsible for the operation of the machinery space.
5. Fire detectors are to be of types, and so located, that they will rapidly detect the onset of fire in conditions normally present in the machinery space. Consideration is to be given to avoiding false alarms. The type and location of detectors are to be approved by the Classification Society and a combination of detector types is recommended in order to enable the system to react to more than one type of fire symptom.
6. Fire detector zones are to be arranged in a manner that will enable the operating staff to locate the seat of the fire. The arrangement and the number of loops and the location of detector heads is to be approved in each case. Air currents created by the machinery are not to render the detection system ineffective.
7. When fire detectors are provided with the means to adjust their sensitivity, necessary arrangements are to be ensured to fix and identify the set point.
8. When it is intended that a particular loop or detector is to be temporarily switched off, this state is to be clearly indicated. Reactivation of the loop or detector is to be performed automatically after a present time.
9. The fire detection indicating panel is to be provided with facilities for functional testing.
10. The fire detecting system shall be fed automatically from the emergency source of power by a separate feeder if the main source of power fails.
11. Facilities are to be provided in the fire detecting system to release manually the fire alarm from the places of passageways having entrances to engine and boiler rooms, navigating bridge, and control station in engine room.

### Section 3 Protection of Accommodation and Service Spaces and Control Stations

#### 303. Requirements for passenger ships carrying not more than 36 passengers

In applying **303. 2** and **305** of the Rules, for sizing the sprinkler pumps and pressure tank of sprinkler system complying with Ch 8 of the FSS code, the calculation method is to be in accordance with the requirements of **MSC.1/Circ.1556. (2018)** **【See Rule】**

#### 305. Cargo ships

As for the methods of divisions and protections for accommodation spaces and service spaces, **Fig 8.5.1** of the Guidance is to be referred to as the standard arrangements. And in case of ships built in accordance with Method IIC, the detection system is only relevant to the accommodation block and then service spaces built away from the accommodation block need not be fitted with a fixed fire detection system. **【See Rule】**

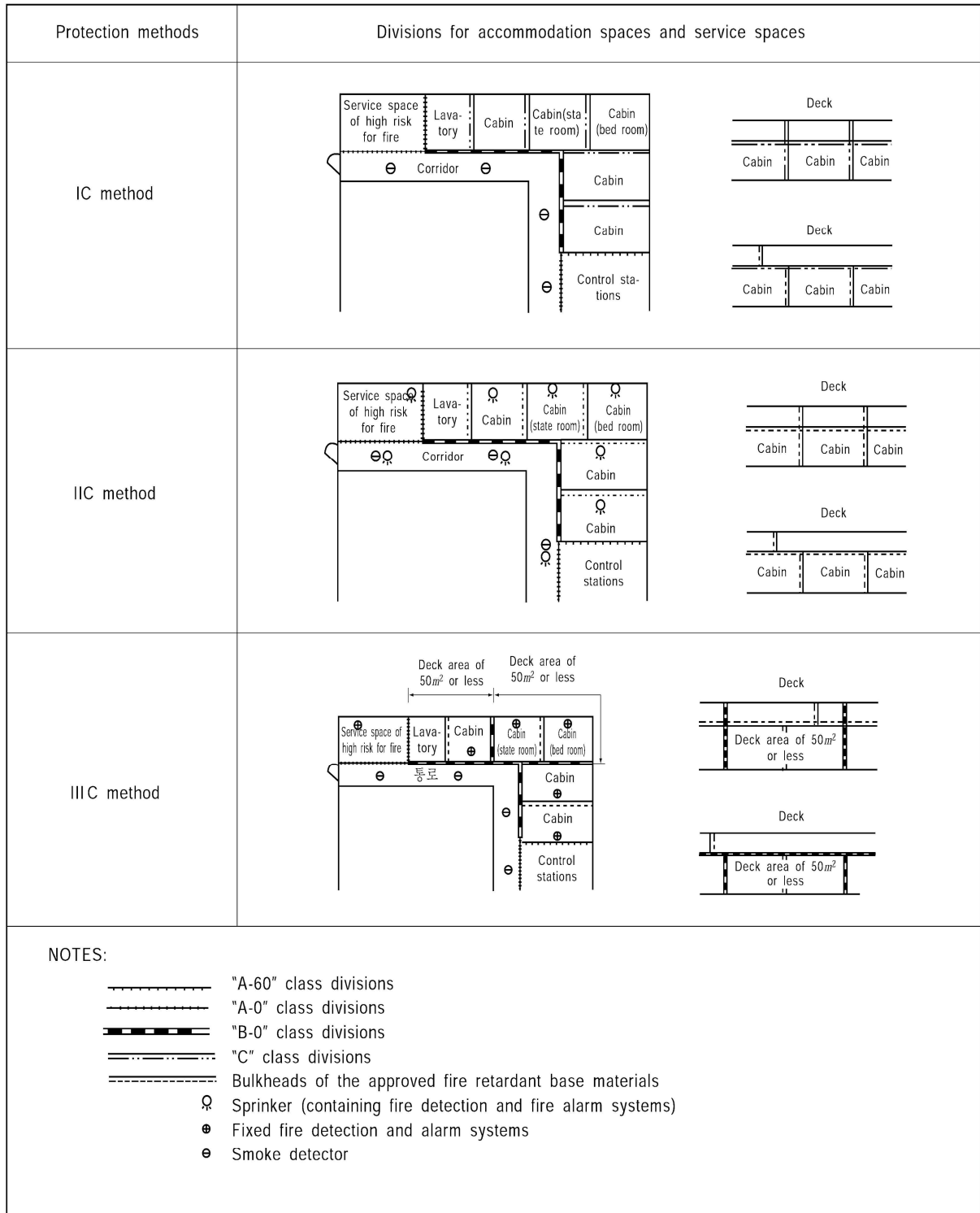

Fig 8.5.1 Method of division and protection for accommodation spaces and service spaces

---

## Section 5 Manually Operated Call Points

### 501. Manually operated call points (2018) [See Rule]

1. In applying 501. of the Rules, "Manually operated call points complying with the FSS Code shall be installed throughout the accommodation spaces, service spaces and control stations" does not require the fitting of a manually operated call point in an individual space within the accommodation spaces, service spaces and control stations. However, the manually operated call points are to be installed at:
  - (1) A manually operated call point shall be located at each exit (inside or outside) to the open deck from the corridor such that no part of the corridor is more than 20 m from a manually operated call point.
  - (2) Service spaces and control stations which have only one access, leading directly to the open deck, shall have a manually operated call point not more than 20 m (measured along the access route using the deck, stairs and/or corridors) from the exit.
  - (3) A manually operated call point is not required to be installed for spaces having little or no fire risk, such as voids and carbon dioxide rooms, nor at each exit from the navigation bridge, in cases where the control panel is located in the navigation bridge.

## Section 8 Protection of cabin balconies on passenger ships

### 801. Protection of cabin balconies on passenger ships [See Rule]

1. Fixed fire detection and fire alarm systems for cabin balconies shall be approved by the Society based on the Guidelines (MSC.1/Circ. 1242).

## CHAPTER 6 CONTROL OF SMOKE SPEED

### Section 1 Protection of Control Stations Outside Machinery Space

#### 101. Protection of control stations outside machinery space [See Rule]

1. The "practicable equipment" means that mechanical ventilation system is preferable, but natural ventilation system may also be accepted. And "where the local closing arrangements are equally effective" means that fire dampers or smoke dampers which are easily closed within the control stations are provided in the ventilation system so that smoke will not be drawn into such a control station in case of fire, and further, any openings, where provided, can be easily and securely closed.

### Section 3 Draft Stops

#### 301. Draft stops [See Rule]

1. Any of the following methods of construction may be used to construct draft stops.
  - (1) The extension of the "B" class bulkhead, ceiling or lining
  - (2) The extension of the "C" class bulkhead, ceiling or lining
  - (3) 1 mm thick minimum steel sheet, stiffened where necessary, intermittently welded to the ship's structure and the top profile of the bulkhead, or fastened mechanically to the ceilings or linings
  - (4) Non-combustible board type material fasten mechanically to the ship's structure, bulkheads, ceilings or linings
  - (5) "A" class mineral wool insulation, not less than 20 mm in thickness, faced on each side with expanded metal mesh, the mesh on one side being attached to the ship's structure or expanded metal mesh may be fitted on one side and non-combustible cloth (glass-cloth) on the other side of mineral wool insulation.
2. The draft stops, in general, are to coincide with the bulkheads where continuous ceilings are used.
3. "14 m apart" means a distance in the direction of the length and breadth of the ship. (2020) ⚓



---

## CHAPTER 7 CONTAINMENT OF FIRE

### Section 1 Thermal and Structural Boundaries

#### 101. Thermal and structural boundaries [See Rule]

1. Spaces of categories for the application of the standards of fire integrity are also to be complied with **Table 8.7.1** of the Guidance.
2. In application to **Ch 7, 102. 4 (4), 103. 3 (4) and 104. 2 (4)** of the Rules, the term "doors may be constructed of materials which are to the satisfaction of the Society." means those complying with the requirements for door required watertight and weathertight specified in Load Line Convention, and where the material of door is non-fire resistant materials is to be complied with the requirements for non-fire resistant materials specified in **Ch 3, 202.** and **Ch 4, Sec 1** of the Rules. (2017)

Table 8.7.1 Categories of spaces of fire integrity

Control stations	Spaces containing navigational apparatus (steering stand, compass and radar equipment), Electric rooms (where charging/discharging panels or battery charges are located), battery rooms, generator rooms(or inverter rooms) for navigational apparatus and radio, Spaces containing control systems and storage rooms of fire-extinguishing medium for fixed fire extinguishing systems(see Note (5) below), Navigation locker(see Note (6) below)
Service spaces (low risk)	Shore connection box rooms, accommodation ladder winch machinery rooms, spaces where distribution panels and starters are located, ballast control rooms, main cargo control rooms Electric rooms (where transformers, switchboards (see Note (7) below), motor-generators, etc. of less than 50 kVA (kW) are located and having areas of less than 4 m <sup>2</sup> )
Other machinery spaces	Storage rooms for hydraulic units for deck machinery and cargo gears, steering gear room (see Note (1) below), Spaces containing deck foam systems (See Note (8) below), inert gas fan rooms, Electric rooms (except those categorized as control stations or service spaces with low risk of fire), Propulsion motor rooms, Propulsion motor control rooms, Emergency fire pump rooms (See Note (9) below), Spaces other than machinery spaces of category A where fuel oil piping lines are located
Service spaces (high risk)	Oxygen or acetylene bottle storage rooms(see Note (2) below), provision store rooms(see Note (3) below), jumper lockers(see Note (4) below), Storage rooms for gaseous fuel (See Note (10) below)
Others	<p>1. Passages under decks of container ships with self-closing gas-tight doors separating the spaces from cargo spaces effectively are to be regarded as void spaces. However, in case where they serve as escape route, they are to be regarded as corridors. (If they serve as second escape route for machinery spaces of category A, they are to be regarded as other machinery spaces.) (2023)</p> <p>2. In this case, locker rooms, store rooms, lavatories for control stations, etc., in which someone may occupy temporarily, having no entrance to corridors but only entrance therefrom may be regarded as an integral part of such spaces. If a space is divided into two(or more) smaller spaces so that these new spaces form enclosed spaces(e.g. a cabinet built in a mess-room, a store room built in a mess-room), these new enclosed spaces are to be surrounded by fire-resistant bulkheads and decks in accordance with Rules.</p> <p>3. Weather decks used to cargo stowage are to be considered as cargo spaces except for cargoes which constitute a low fire risk.</p> <p>4. Ventilating fan rooms within refrigerated cargo spaces and cargo handling gear locker which can be accessible only from ro-ro spaces or vehicle spaces may be regarded as a part of Cargo spaces, ro-ro and vehicle spaces respectively.</p> <p>5. Duct spaces and cable trunks are to apply to the requirements of <b>103. 4</b> of the Rules for lift trunks</p>

**Table 8.7.1 Categories of spaces of fire integrity (continued)**

<p>Notes:</p> <ol style="list-style-type: none"> <li>(1) In case where an emergency fire pump is installed in the steering gear room or spaces which are only accessible directly therefrom, the fire integrity of boundaries between the space where the main fire pump is installed and the steering gear room is to be in accordance with <b>Fig 8.8.2</b> of the Guidance.</li> <li>(2) In case where one side or more of the walls are open to exposed deck, such storage rooms may be regarded as those on open deck.</li> <li>(3) Refrigerated provision chambers are to be service spaces(high risk) if thermally insulated with combustible materials, or service spaces(low risk) if thermally insulated with non-combustible material. Provision chambers having areas of less than 4 m<sup>2</sup> may be considered as a service space with low risk of fire.</li> <li>(4) In case where jumper lockers are used as Oil skin lockers, they are regarded as high risk service spaces, except for Oil skin lockers, they are regarded as accommodation spaces.</li> <li>(5) Except where permitted to be stored in the space protected by that fixed fire-extinguishing system according to the type of the system.</li> <li>(6) A navigation locker that can only be accessed from the wheelhouse should be considered as a control station, and the bulkhead separating the wheelhouse and such a locker should have fire integrity of at least "B-0" class.</li> <li>(7) Small distribution boards may be located behind panels/linings within accommodation spaces including stairway enclosures, provided no provision is made for storage. Such location need not to be considered as a separate space nor categorized as a service space with low risk of fire.</li> <li>(8) Attention is paid to the provisions of <b>Ch 2, 402. 2</b> of the Guidance.</li> <li>(9) The fire integrity of boundaries separating from the space where the main fire pump is installed is to be in accordance with <b>Ch 8, 102. 3 (2) (A)</b> of the Rules.</li> <li>(10) The provisions of <b>Ch 2, 201.</b> of the Rules are to apply. In case where a portion of open deck, recessed into deck structure, machinery casing, deck house, etc., utilized for the exclusive storage of gas bottles in accordance with the provisions of <b>Ch 2, 201.</b> of the Guidance, such a location may be regarded as open decks.</li> </ol>
---

3. In cases where urea or sodium hydroxide solution tanks for selective catalytic reduction (SCR) systems, exhaust gas recirculation (EGR) systems or exhaust gas cleaning systems (EGCS) are installed in a space separated from the engine-room, in determining fire integrity of divisions, the solution tank space should be considered as "similar spaces" in the definition of "machinery spaces" in **Ch 1, 103. 30** of the Rules and should be categorized as: (2020)

- (1) for ships carrying more than 36 passengers; "⑩ Tanks, voids and auxiliary machinery spaces having little or no fire risk" in **Ch 7, 102. 3 (2) (B)** of the Rules, or
- (2) for ships carrying not more than 36 passengers and cargo ships: "⑦ Other machinery spaces" in **Ch 7, 102. 4 (2) (B), Ch 7, 103. 3 (2) (B) and Ch 7, 104. 2 (2) (B)** of the Rules.

The division between the engine-room and the solution tank space should have a fire integrity of at least "A-0" class.

## 102. Passenger ships

1. In applying **102. 1 (2)** of the Rules, if a stairway serves two main vertical zones, the maximum length of any one main vertical zone need not be measured from the far side of the stairway enclosure. In this case all boundaries of the stairway enclosure are to be insulated as main vertical zone bulkhead and access doors leading into the stairway are to be provided from the two outside zones. The number of main vertical zone of 48 m is not limited as long as they comply with all the requirements.

**[See Rule]**

2. In applying "acceptable material for "B" class divisions" in **102. 2** of the Rules, if the extended bulkhead is of B-0 class standard, then the extension may be made of thin steel plates of 1.6mm thickness or a suitably supported mineral wool (density at least 100 kg/m<sup>3</sup>, thickness at least 50 mm).(2018) **[See Rule]**

3. In applying **102. 2 (3)** of the Rules, if an air gap between cabins results in an opening in the continuous class B-15 ceiling, the bulkheads on both sides of the air gap are to be of class B-15.

**[See Rule]**

4. In applying **102. 3** (1) of the Rules, distribution board may be located behind panels/linings within accommodation spaces including stairway enclosures, without the need to categorize the space, provided no provision is made for storage. **【See Rule】**
5. Fire risk assessments for furniture and furnishings in external areas(e.g. evacuation stations and external escape routes, open deck space) in **102. 3** (2) of the Rules may refer to MSC.1/Circ.1274 (as amended). (2020)
6. In applying **102.3**(2) (B) ⑨ of the Rules, "Isolated pantries containing no cooking appliances in accommodation spaces" are pantries enclosed in an accommodation space and are only accessible from accommodation spaces and/or open deck. For the purpose of this categorization, "accommodation space" is as defined in **103. 1** of the Rules. These pantries should not have communicating openings to spaces other than accommodation spaces, such as "main galley" in category ⑫ (see **Fig 8.7.1** of the Guidance).

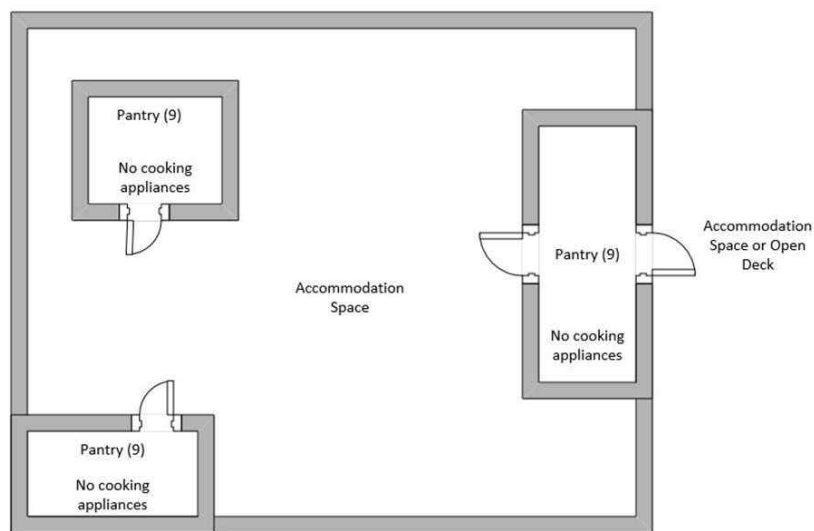

**Fig 8.7.1** Example of isolated pantries containing no cooking appliances in accommodation spaces

### 103. Cargo Ships except tankers

1. In applying **103. 1** (1) (C) of the Rules, increasing area for public spaces is, in principle, to be limited to 75 m<sup>2</sup>. **【See Rule】**
2. In applying **103. 4** (1) of the Rules, stairway penetrating more than a single deck are to be protected in accordance with the following requirements: **【See Rule】**
  - (1) In case where stairways and passages are provided in stairway enclosures and access to other decks is possible through such stairway enclosures, self-closing "A" class fire doors are to be provided at each deck level(see **Fig 8.7.2** (a) of the Guidance).
  - (2) In case where only stairways are provided in stairway enclosures and access to other decks is made through outside the enclosures at each deck level, the following requirements are to be complied with:
    - (A) In case of stairways with open steps, they are to be protected by self-closing "A" class fire doors at each deck level and at each end of a stair(see **Fig 8.7.2** (b) of the Guidance).
    - (B) In case of stairways with closed steps, self-closing "B" class fire doors are to be provided at least at one end of each stair (see **Fig 8.7.2** (c) of the Guidance).
3. In applying **Table 8.7.5** and **8.7.6** of the Rules, the following requirements are to be applied.
  - (1) Decks and bulkheads  
Decks and bulkheads to be insulated to "A-30" fire integrity are those boundaries of single spaces protected by their own fire-extinguishing system.
  - (2) Hatches  
Class "A" fire integrity respectively does not apply to hatches fitted on open deck adjacent to

ro-ro/vehicle spaces and on decks separating ro-ro/vehicle spaces, provided that such hatches are constructed of steel.

(3) Access doors

"A-0" fire integrity does not apply to access doors to ro-ro/vehicle spaces fitted on open decks, provided that such access doors are constructed of steel.

(4) Movable ramps

Movable ramps installed on decks referred to in (1) above which form boundaries of "A-30" fire integrity shall be constructed of steel and shall be insulated to "A-30" fire integrity, except for the "working parts" of such movable ramps (e.g. hydraulic cylinders, associated pipes/accessories) and members supporting such fittings which do not contribute to the structural strength of the boundary. Such movable ramps need not be subject to fire test. This is applicable to non-water-tight doors used for loading/unloading of vehicles.

(5) Ventilation ducts

Where ducts for a ro-ro/vehicle spaces pass through other ro-ro/vehicle spaces without serving those spaces, each duct shall be insulated all along itself to "A-30" fire integrity in ways of other ro-ro/vehicle spaces unless the sleeves and fire dampers in compliance with **Ch 7, 603. 1** of the Rules in order to prevent spread of fire through the ducts are fitted. (2017)

(6) Ventilators

"A-0" fire integrity does not apply to ventilators constructed of steel fitted on open decks adjacent to ro-ro/vehicle spaces. (2017)

Structural configuration	Structural details
<p>(a) Stairways accessible to other decks not going out of the stairway enclosures</p>	
<p>(b) Only stairways with open steps are surrounded by an enclosure and access to other decks is made through outside the enclosure at each deck level and each end a stair.</p>	
<p>(c) Only stairways with closed steps are surrounded by an enclosure and access to other decks is made through outside the enclosure at each deck level and one end of each stair.</p>	
<p><i>f</i> : Self-closing "A" class fire door  <b>F</b> : Self-closing "B" class fire door</p>	

Fig 8.7.2 Protection of the stairway enclosures penetrating more than a single deck

### 104. Tankers

1. In applying **104. 2** (5) of the Rules, insulation of superstructures and deckhouses facing the cargo area are to be in accordance with the following requirements: **【See Rule】**
  - (1) "The outward sides for a distance of 3 m from the end boundary" refer to the **Fig 8.7.3** (a) of the Guidance.
  - (2) In the case of the arrangement as shown in **Fig 8.7.3** (b) of the Guidance, "A-60" class insulation is to be applied to the aft end bulkhead of deck store and side walls of accommodation spaces and service spaces of 3 m from the fore end thereof where they form the external boundaries of accommodation spaces and service spaces.
  - (3) "A-60" class Insulation requirements for the side walls for 3 m aft of the front bulkhead are to apply to all areas in the vertical direction up to the underside of the deck of the navigation bridge for superstructures and deckhouses.
  - (4) The side walls of a wheelhouse having the structural arrangement unlikely to be exposed to flames in case of fire in way of cargo area(e.g. structural arrangement of a wheelhouse provided on the sponson deck) may not be provided with the insulation.

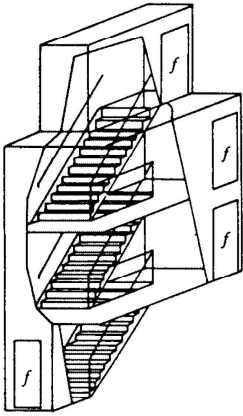
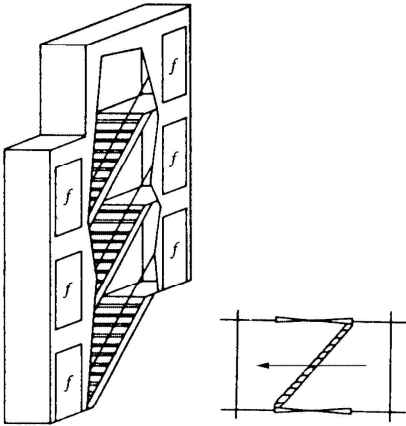
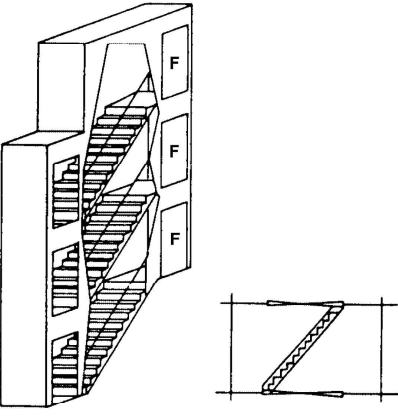
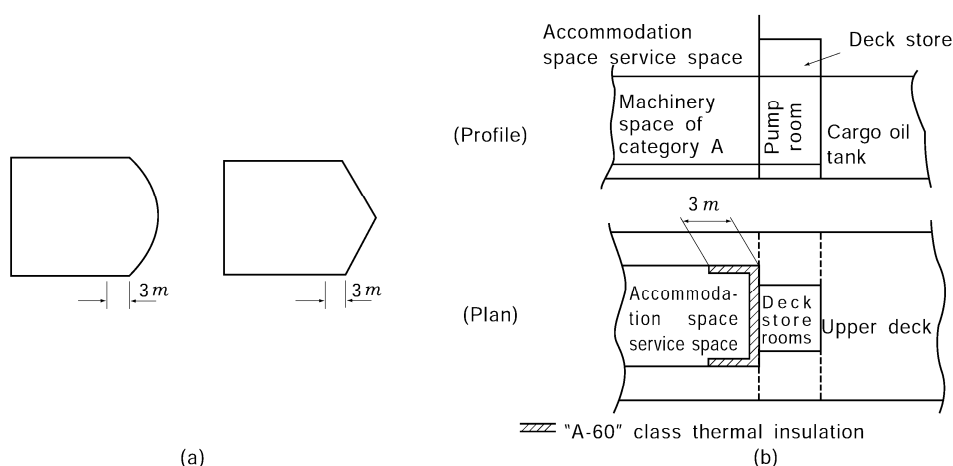

**Fig 8.7.3 Insulation of superstructures and deckhouses facing the cargo area**

2. In application to **Ch 3, 102. 4** (5), **103. 3** (4) and **104. 2** (4) of the Rules, the term "doors may be constructed of materials which are to the satisfaction of the Society." means those complying with the requirements for door required watertight and weathertight specified in Load Line Convention and material of door is to be complied with the requirements for non-fire resistant materials specified in **Ch 3, 202.** and **Ch 4, Sec 1** of the Rules. **【See Rule】**

## Section 2 Penetration in Fire-resisting Divisions and Prevention of Heat Transmission

### 201. Penetration in fire-resisting divisions and prevention of heat transmission **【See Rule】**

1. The structural arrangements penetrated through "A" or "B" class divisions are to be in accordance with **Annex 8-2** of the Guidance, and in addition electric cable penetrations are also to be complied with the requirement of **Pt 6, Ch1, 508.** of the Guidance.
2. In applying **201. 4** of the Rules, treatment of terminal points and intersections of insulated bulkheads and decks" is to be in accordance with **Fig 8.7.4** of the Guidance.

Treatment of terminal points and intersections	Structural details
<p>(1) Insulation of stiffeners, girders, etc., in case where their depth is 450 mm or less, is to be applied to the whole structure including the flanges or faceplates. Where the depth exceeds 450 mm, such insulation is to be applied to at least 450 mm in depth from bulkheads or decks. However, in case where the fire integrity has been verified by a standard fire test, this requirement may be dispensed with.</p>	
<p>(2) The structural extension of insulation at intersections between uninsulated bulkheads, decks or brackets is to be 450 mm or more.</p>	
<p>(3) In case where the lower part of insulation has to be cut for drainage, the construction is to be in accordance with the structural details.</p>	 <p>* : Lining and steel coaming/gutter bar are for accommodation spaces only. ** : For the purpose of figure above, bulkhead and deck are of steel construction only.</p>
<p><math>t</math> : Thickness of thermal insulation <math>d</math> : Depth of stiffener or girder</p>	

Fig 8.7.4 Treatment of terminal points and intersections of insulated bulkheads and decks

### Section 3 Protection of Openings in Fire-resisting Divisions

#### 301. Openings in bulkheads and decks in passenger ships

- In applying 301. 1 (7) of the Rules, doors which open to exposed areas from stairways need not apply the criteria of A class integrity, and the requirements of (5) need not apply. (For doors which open to outside stairways and open decks which are used for life saving appliances, evacuation stations, outside muster stations and escape routes, the doors are to be constructed of steel or other equivalent materials.) However, windows installed in the doors are to be constructed of A-60 or A-0 + sprinkler head for windows. (2018) **[See Rule]**

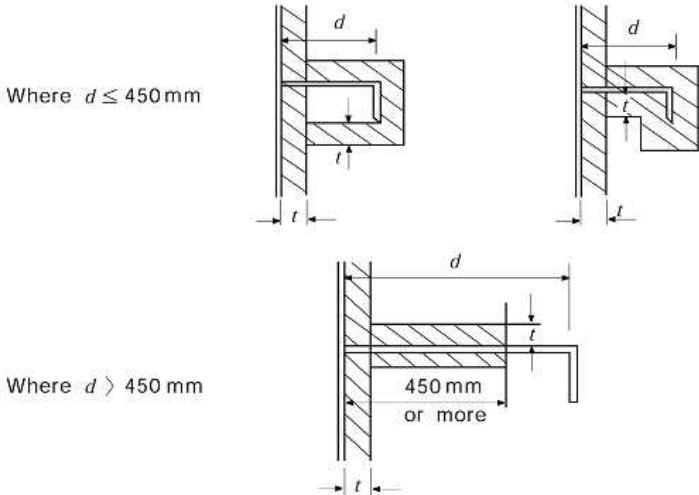
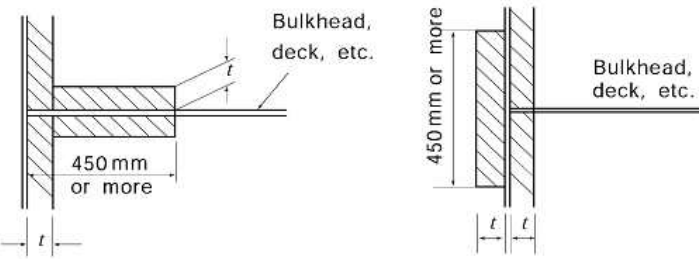
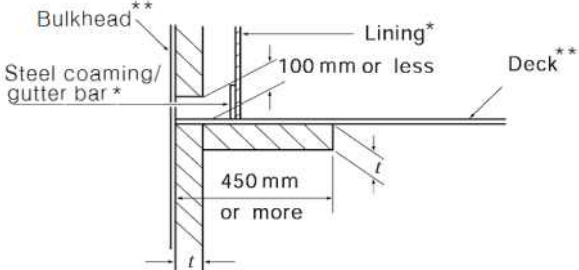

2. Balancing openings or ducts between two enclosed spaces are prohibited except for openings as permitted by **301. 2** & **302.** of the Rules. **[See Rule]**
3. In applying **301. 3** (3) (C) of the Rules, should be in accordance with the **Res.MSC.265(84)** and **Res.MSC.284(86)**. **[See Rule]**

### **302. Doors in fire-resisting divisions in cargo ships [See Rule]**

1. In applying **302. 1** of the Rules, where required divisions are replaced by divisions of a higher standard, the door need only conform to the required division.
2. In applying **302. 2** of the Rules, "Remote release devices of fail-safe type" means the system which releases hooks or other equivalent devices by remote operation, and that the door is automatically closed even in case of failure of the system.
3. In applying **302. 3** of the Rules, in case where ventilation openings are provided on corridor bulkheads, the following requirements are to be complied with
  - (1) For corridor bulkheads except stairway enclosures required to have "B" class fire integrity, "B" class fire door with louvres of approved type leading to lavatories, offices, pantries, lockers and store rooms may be provided. In this case, the louvres are to be capable of being closed from the corridor side.
  - (2) For duct trunks adjoining to corridor bulkheads, ventilation openings with manual closing appliances may be provided. In this case, grids made of non-combustible materials are to be fitted to the ventilation openings. Furthermore, in case where the sectional area of such a ventilation opening exceeds 0.075 m<sup>2</sup>, self-closing type fire damper is to be provided in addition to the manual closing appliances.

## **Section 5 Protection of Cargo Space Boundaries**

### **501. Protection of cargo space boundaries**

When ships are designed to transport alternatively oil or dry cargoes, openings which may be used for cargo operations are not permitted in bulkheads and decks separating oil cargo spaces from other spaces not designed and equipped for the carriage of oil cargoes unless alternative approved means are provided to ensure equivalent integrity. **[See Rule]**

## **Section 6 Ventilation Systems [See Rule]**

### **601. General**

1. Exhaust ventilations of accommodation spaces, service spaces and control stations to be effected through the exhaust ventilation ducts except where ventilation openings are accepted under **302. 3** of the Guidance.
2. In applying **601. 1.** of the Rules, a ventilation duct made of material other than steel may be considered equivalent to a ventilation duct made of steel, provided the material is non-combustible and has passed a standard fire test in accordance with Annex 1: Part 3 of the FTP Code as non-load bearing structure for 30 minutes following the requirements for testing "B" class divisions.(SC264)
3. In applying **601. 1.** (1) of the Rules, the measurement of calorific value is to be in accordance with **ISO 1716**.

### **602. Arrangement of ducts**

1. In applying **602. 4** of the Rules, "A-60" class insulation" is, as a standard, to be an insulation with rock-wool approved as non-combustible material, or insulation approved as "A-60" class standard and arrangement of ducts are to be in accordance with **Fig 8.7.5** of the Guidance.

2. In applying **602.** and **605. 1 & 2** of the Rules for determining fire insulation for trunks and ducts which pass through an enclosed space, the term "pass through" means the part of the trunk/duct contiguous to the enclosed space. (see **Fig 8.7.6** of the Guidance.) (2024)

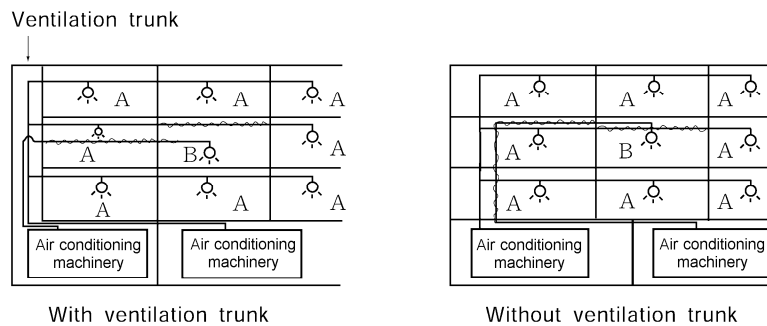

A: Accommodation spaces, service spaces excluding galleys or control stations  
B: Machinery spaces of category A, galleys, car deck spaces or ro-ro cargo spaces

**Fig 8.7.5 Examples for arrangements of Ventilation system**

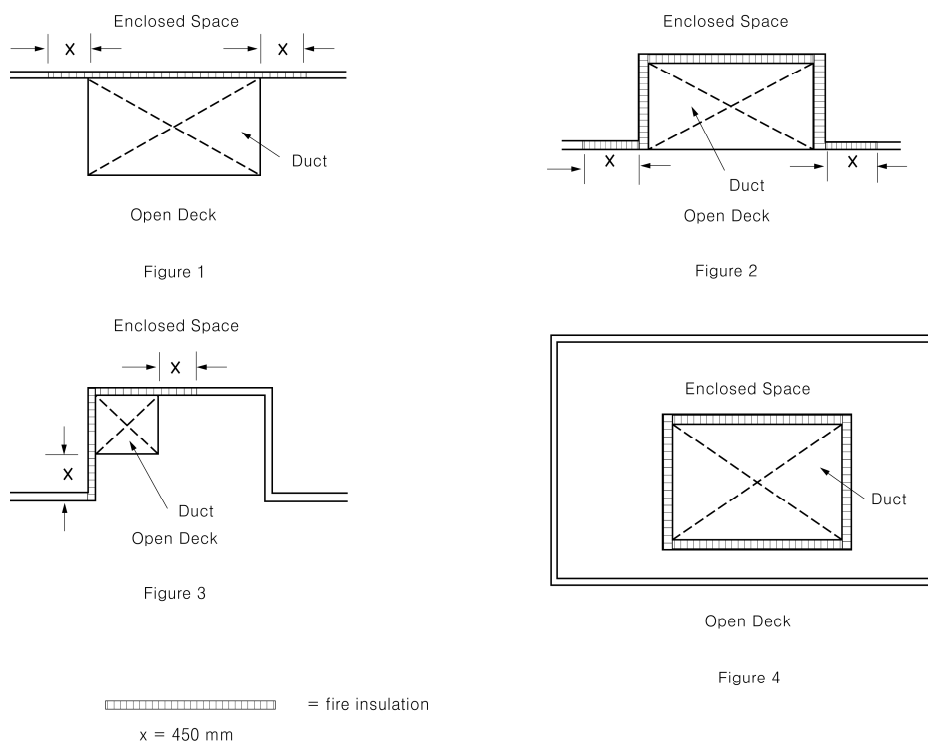

**Fig 8.7.6 Examples of ducts contiguous to enclosed space**

**603. Details of fire dampers and duct penetrations**

1. In applying **603. 1 (3)** of the Rules, "Fire dampers automatically" is to be the fuse type dampers or those considered to be equivalent by the Society. "Being closed manually" means closing by mechanical means of release or by remote operation of the fire damper by means of a fail-safe electrical switch or pneumatic release (spring-loaded, etc.) on both sides of the division.
2. Ventilation inlets and outlets located at outside boundaries are to be fitted with closing appliances as required by **Ch 3 101.** of the Rules and need not comply with **603.** of the Rules.

3. In applying **603. 1** of the Rules, ducts or pipes with free sectional area of  $0.075 \text{ m}^2$  or less need to be fitted with fire damper at their passage through Class "A" divisions in those cases indicated in **602. 2** and **3** of the Rules. The fire damper can be omitted if the duct is arranged in compliance with the requirements of **602. 4** (5) and (6) of the Rules.
4. When a duct passing through a division is to be in accordance with **201. 2** and **603. 2** of the Rules, no clearance should be allowed between the duct and the B class division. (2024)

#### **605. Exhaust ducts from galley ranges (2017)**

1. The exhaust ducts from galley ranges are to be in accordance with the following requirements: (2021)
  - (1) The exhaust ducts from galley ranges are, in principle, to be independent from other ducts. In case where this is impracticable, self-closing type fire dampers which can be remotely operated are to be fitted to the other branch ducts in order to be capable of closing these dampers together with those for galley ranges simultaneously.
  - (2) Unless otherwise permitted by the Society, the term of "spaces containing combustible materials" will normally apply to all spaces in accommodation.
  - (3) With respect to fixed means for extinguishing a fire specified in **1** (3) & **3** (4) of the rules, these are to be apply ISO 15371 which is given as an example of a suitable performance standard for pre-engineered galley duct fixed fire-extinguishing systems. CO2 fire-extinguishing systems, which are not applicable to ISO 15371 should be designed according to the requirements set out in **Ch 8, 503. 1** (1) of the Rules (spaces containing flammable liquids) or another suitable standard acceptable to the Society. (2020)
2. In applying **605. 1** of the Rules, the requirements to exhaust ducts from galley ranges in which grease or fat is likely to accumulate will apply to all exhaust ducts from galley ranges.(SC 108)
3. In applying **605. 1** and **3** of the Rules, fire dampers do not need to pass the fire test in either **Res. A. 754(18)** or **FTP code Annex 1 Part 3**, but should be of steel and capable of stopping the draught. The requirements to "A" class applies only to the part of the duct outside of the galley. And the term "spaces containing combustible materials" will normally apply to all spaces in accommodation. ↓

## CHAPTER 8 FIRE FIGHTING

### Section 1 Water Supply System

#### 101. Water supply systems

1. In application to **101. 4** (1) of the Rules, the following requirements are to be complied with. **[See Rule]**
  - (1) Any part of the fire main routed through a category A machinery space, except for short lengths of suction or discharge piping complying with **101. 4** (1) of the Rules, shall be fitted with isolating valves outside of the space. The arrangements of the fire mains shall allow for fire water from the fire pumps or emergency fire pump to reach all hydrants outside of the isolated space. Isolating valves are not applicable to the piping from fire pumps located in spaces other than category A machinery spaces.
  - (2) In cases where suction or discharge piping penetrating machinery spaces are enclosed in a substantial steel casing, or insulated to "A-60" class standards, it is not necessary to insulate distance pieces, sea inlet valves and sea-chests.
  - (3) The method for insulating pipes to "A-60" class standards is that they are to be covered/protected in a practical manner by insulation material which is approved as a part of "A-60" class divisions in accordance with the FTP Code.
  - (4) Where the sea inlet valve is in the machinery space, the valve should not be a fail-close type. Where the sea inlet valve is in the machinery space and is not a fail-open type, measures should be taken so that the valve can be opened in the event of fire, e.g. control piping, actuating devices and/or electric cables with fire resistant protection equivalent to "A-60" class standards.
  - (5) In cases where main fire pumps are provided in compartments outside machinery spaces and where the emergency fire pump suction or discharge piping penetrates such compartments, the above interpretation is to be applied to the piping.
2. In application to **101. 4** (4) of the Rules, the complete interpretation of the phrase "the isolation valves shall be fitted in the fire main at the poop front in a protected position" would be that the valve should be located within an accommodation space, service spaces or control station. However, the valve may be located on the open deck aft of the cargo area provided that the valve is located: *(2018)* **[See Rule]**
  - (1) at least 5 m aft of the aft end of the aftermost cargo tank; or
  - (2) if the above .1 is not practical, within 5 m aft of the aft end of the aftermost cargo tank provided the valve is protected by a permanent steel obstruction.
3. In applying **101. 6** of the Rules, the minimum pressure is to be sufficient to produce a 12 m jet throw, through any adjacent hydrants, to any part of the ships referred to **401. 5** (1) of the Rules, on passenger and cargo ships under 1,000 tonnes gross tonnage. **[See Rule]**
4. In applying **101. 7** of the Rules, Standard dimensions of flanges for the international shore connection shall be in accordance with the **Table 8.8.1** of the Guidance. And International shore connections shall be of steel or other equivalent material and shall be designed for 1.0 MPa services. The flange shall have a flat face on one side and, on the other side, it shall be permanently attached to a coupling that will fit the ship's hydrant and hose. The connection shall be kept aboard the ship together with a gasket of any material suitable for 1.0 MPa services. **[See Rule]**

Table 8.8.1 Standard dimensions of flanges for the international shore connection

Description	Dimension
Outside diameter	178 mm
Inside diameter	64 mm
Bolt circle diameter	132 mm
Slots in flange	4 holes 19 mm in diameter spaced equidistantly on a bolt circle of the above diameter, slotted to the flange periphery
Flange thickness	14.5 mm minimum
Bolts and nuts	4 ea, each of 16 mm diameter, 50 mm in length including eight(8) washers

### 102. Fire pump

1. In applying **102. 3** of the Rules, on ships for navigation in ice, on ships for navigation in polar water and on ships for navigation in polar and ice breaking service is to be in accordance with the relevant requirements in **Ch 1, 702.**, **Ch2 308.** and **Ch 2 408.** of **Guidance for Ships for Navigation in Ice.** **[See Rule]**
2. In applying **102. 3** (1) (B) of the Rules, the following requirements are to be complied with.
  - (1) The electrical cables to the emergency fire pump are not to pass through the machinery spaces containing the main fire pumps and their sources of power and prime movers. They are to be of a fire resistant type approve by the Society, where they pass through other high fire risk areas.
  - (2) Unless the two main fire pumps, their sea suction and the fuel supply or source of power for each pump are situated within compartments separated at least by A-0 divisions, so that a fire in any one compartment will not render both fire pumps inoperable, an emergency fire pump should be fitted.
  - (3) An arrangement in which one main fire pump is located in a compartment having more than one bulkhead adjacent to the compartment containing the other main fire pump should also require an emergency fire pump.
3. In applying **102. 3** (2) of the Rules, emergency fire pumps is not applicable to passenger ships of 1,000 gross tonnage and upwards and is also, in principle, to be complied with as follows,
  - (1) The emergency fire pump shall be of a fixed independently driven power-operated pump.
  - (2) Capacity of emergency fire pump **[See Rule]**
    - (A) The capacity of the pump shall not be less than 40 % of the total capacity of the fire pumps specified in **102. 4** of the Rules and in any case not less than
      - (a) for passenger ships less than 1000 gross tonnage and for cargo ships of 2000 gross tonnage and upwards ; 25 cubic meters/h
      - (b) for cargo ships less than 2000 gross tonnage ; 15 cubic meters/h.
    - (B) In applying **301. 1** of the Rules, where a fixed water-based fire extinguishing system installed for the protection of the machinery space of cargo ships is supplied by the emergency fire pump, the emergency fire pump capacity shall be adequate to supply the fixed fire extinguishing system at the required pressure plus two jets of water. The capacity of the two jets shall in any case be calculated by that emanating from the biggest nozzle size available onboard from the **Table 8.8.2** of the Guidance(When selecting the biggest nozzle size available onboard, the nozzles located in the space where the main fire pumps are located can be excluded), but shall not be less than 25 m<sup>3</sup>/h

Table 8.8.2 Capacity of single jet

Pressure at Hydrant	Nozzle size	
	16 mm	19 mm
0.27 N/mm <sup>2</sup>	16 m <sup>3</sup> /h	23.5 m <sup>3</sup> /h

- (3) When the pump is delivering the quantity of water required by paragraph (2) the pressure at any hydrants shall be not less than the minimum pressure specified in the Rules.
- (4) The total suction head and the net positive suction head of the pump are to be determined having due regard to the requirements on the pump capacity and on the hydrant pressure under all conditions of list, trim, roll and pitch likely to be encountered in service. The ballast condition of a ship on entering or leaving a dry dock need not be considered a service condition. In all cases the net positive suction head (NPSH) available for the pump is to be greater than the NPSH required. Upon completion of the emergency fire pump installation, a performance test confirming the capacity required in **102. 3 (2)** of the Guidance is to be carried out and, if the emergency fire pump is the main supply of water for any fixed fire extinguishing system provided to protect the spaces where the main fire pumps are located, the pump is to have the capacity for this system. As far as practicable, the test should be carried out at lightest seagoing draught at the suction position. It is to be documented that the suction inlet is fully submerged under “all conditions of list, trim, roll and pitch likely to be encountered in service” as given below.
- (A) Operational seagoing condition for which roll, pitch and heave are to be applied is as follows. The lightest seagoing condition is to be considered, which is defined as the ballast condition which gives the are shallowest draught at the position of the sea chest and emergency fire pump as given in the approved stability booklet(or preliminary stability calculation for new building). The following table is to be applied for the calculation of roll, pitch and heave. The heave combined pitch and heave combined roll are taken into account separately.
- (a) Heave combined pitch (The heave combined pitch is taken into account as in **Fig 8.8.1** of the Guidance.) in head sea

L (m)	75 and below	100	125	150	175	200	225	250	300	350 and above
$\Phi$ (deg)	4.5	4	3.2	2.7	2.3	2.1	1.8	1.7	1.6	1.5
H (m)	0.73	0.8	0.87	0.93	0.98	1.03	1.07	1.11	1.19	1.25

Note: Values at the intermediate length of ships are to be obtained by linear interpolation.

Where:

- L : length of the ship, in meters, as defined in the International Convention on Load Lines in force, or length between perpendiculars at the ballast draught, whichever is greater
- $\varphi$  : pitch angle (measured from still waterline and downwards) as defined in **Fig 8.8.1** of the Guidance
- H : heave amplitude as defined in **Fig 8.8.1** of the Guidance
- (b) Heave combined roll in beam sea  
Heave combined roll angle(measured from still waterline and downwards) is to be taken as:
- ( i ) ships with bilge keels: 11°
  - ( ii ) ships without bilge keels: 13°

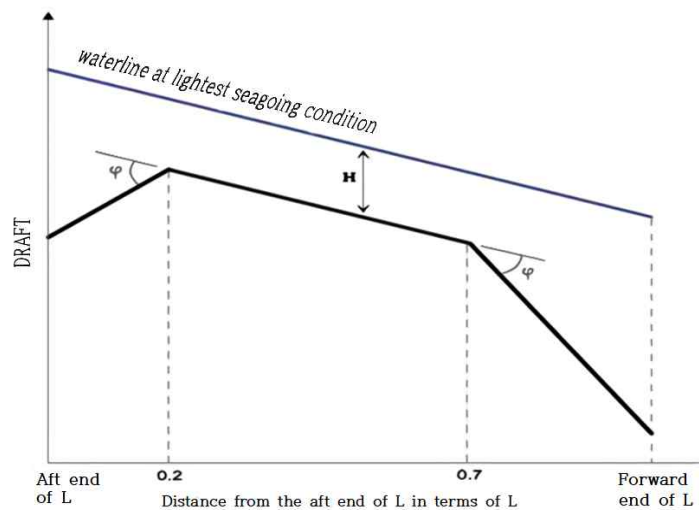

Fig 8.8.1 Waterline for which heave combined pitch is taken into account

- (B) The emergency fire pump suction is to be submerged at the waterlines corresponding to the two following conditions and for either condition, roll, pitch and heave need not be applied.
- (a) a static waterline drawn through the level of 2/3 immersion of the propeller at even keel (for pod or thruster driven ship, special consideration should be given)
  - (b) the ship in the arrival ballast condition, as per the approved trim and stability booklet, without cargo and with 10% stores and fuel remaining.
- (C) A ship operating solely in sheltered water is to be subject to compliance with the still water submergence requirements set out in paragraph (B) (a)
- (5) Any diesel driven power source for the pump shall be capable of being readily started in its cold condition down to the temperature of 0 °C by hand(manual) cranking. Where ready starting cannot be assured, if this is impracticable, or if lower temperatures are likely to be encountered, and if the room for the diesel driven power source is not heated, electric heating of the diesel engine cooling water or lubricating oil system is to be fitted, to the satisfaction of the Society. If hand(manual) starting is impracticable, the Society may permit compressed air, electricity, or other sources of stored energy, including hydraulic power or starting cartridges to be used as a means of starting. These means shall be such as to enable the diesel driven power source to be started at least six times within a period of 30 min and at least twice within the first 10 min.
  - (6) Any service fuel tank shall contain sufficient fuel to enable the pump to run on full load for at least three hours and sufficient reserves of fuel shall be available outside the machinery space of category A to enable the pump to be run on full load for an additional 15 h.
  - (7) The room where the pump and prime mover are installed is to have adequate space for maintenance work and inspections .
  - (8) Where necessary to ensure priming, the emergency fire pump should be of the self priming type.
  - (9) Where a power-operated emergency fire pump is fitted, its fuel or power supply is to be so arranged that it will not readily be affected by a fire in the compartment containing the main fire pumps. (2024)
4. In applying 102. 3 (2) (A) of the Rule, when a single access to the emergency fire pump room is through another spaces adjoining a machinery space of category A or the spaces containing the main fire pumps, class A-60 boundary is required between the other space and the machinery space of category A or the spaces containing the main fire pumps.
  5. In applying 102. 3 (2) (B) of the Rule, if a direct access between machinery spaces provided with the main fire pumps are installed and spaces provided with an emergency fire pump or the second means of access to the space provided with an emergency fire pump is inevitably provided, Fig 8.8.2 of the Guidance is to be referred to as the standard arrangements.

6. In applying **102. 3** (3) of the Rules, this paragraph does not force designers to choose pumps with capacity and pressure characteristics other than that being optimal for the service intended, just to make their connection to the fire main possible, provided the required number and capacity of fire pumps are already fitted.

**103. Fire hoses and nozzles [See Rule]**

Aluminium alloys may be used for fire hose couplings and nozzles, except in open deck areas of oil tankers and chemical tankers. And fire hose nozzles made of plastic type material, e.g. polycarbonate, are considered acceptable provided capacity and serviceability are documented and the nozzles are found suitable for the marine environment.



Construction	Structural details	
In case where a watertight door is provided	1st corridors	 <p>(Machinery space)</p> <p>Bulkhead Trunk Hatch(opening) Space where emergency fire pump is installed (Steering gear room)</p> <p>"A-60" class division</p> <p>Remotely operated watertight door(no thermal insulation is required.) which is also capable of being closed from a place near the door from the side of the space where an emergency fire pump is installed.</p> <p>* : Extension of thermal insulation is to be 450mm or more. ** : Either of these is to be provided.</p>
	In case where an air lock is provided	 <p>(Machinery space)</p> <p>Bulkhead Trunk Hatch(opening) Space where emergency fire pump is installed (Steering gear room)</p> <p>"A-60" class division</p> <p><math>f_1</math> : Reasonably gastight self-closing door of "A-60" class without any hold back arrangement <math>f_2</math> : Reasonably gastight self-closing door of steel or other equivalent material without any hold back arrangement</p> <p>* : Extension of thermal insulation is to be 450mm or more. ** : Either of these is to be provided.</p>
In case where a direct access is provided between machinery spaces and spaces provided with an emergency fire pump	2nd corridors	 <p>Steering gear room Hatch(opening) Space where emergency fire pump is installed</p> <p>"A-60" class division</p> <p>Application of thermal insulation (transverse section)</p> <p>450 mm or more</p> <p>Space where emergency fire pump is installed</p> <p>(Section A-A' of figure of 1st corridors)</p>
	In case where a trunk is provided	 <p>"A-0" class division Steering gear room "A-0" class division Trunk Space where emergency fire pump is installed</p> <p>"A-60" class division</p> <p>Application of thermal insulation (transverse section)</p> <p>Trunk "A-0" class division Space where emergency Fire pump is installed</p> <p>450 mm or more</p> <p>(Section A-A' of figure of 1st corridors)</p> <p>*Self-closing door may be provided between the trunk and steering gear room.</p>

Fig 8.8.2 Corridors in machinery spaces and spaces provided with emergency fire pumps

## Section 2 Portable Fire Extinguisher

### 201. Portable fire extinguisher [See Rule]

1. All fire extinguishers shall be of approved types and designs based on the guidelines **Res. A. 951(23)** developed by the IMO.
2. Each powder or carbon dioxide extinguisher shall have a capacity of at least 5 kg, and each foam extinguisher shall have a capacity of at least 9 L. The mass of all portable fire extinguishers shall not exceed 23 kg, and they shall have a fire-extinguishing capability at least equivalent to that of a 9 L fluid extinguisher.
3. Only refills approved for the fire extinguisher in question shall be used for recharging.
4. In applying **401. 2 (1)** and **402. 2 (2)** of the Rules, a portable foam applicator unit shall consist of a foam nozzle/branch pipe, either of a self-inducing type or in combination with a separate inductor, capable of being connected to the fire main by a fire hose, together with a portable tank containing at least 20 L of foam concentrate and at least one spare tank of foam concentrate of the same capacity, and the System performance is as follows.
  - (1) The nozzle/branch pipe and inductor shall be capable of producing effective foam suitable for extinguishing an oil fire, at a foam solution flow rate of at least 200 L/min at the nominal pressure in the fire main.
  - (2) The foam concentrate shall be approved by the Flag Administration in which the ship is registered or to be registered based on the guideline developed by the IMO. However, in case where there is no expressly provided national regulations, the foam concentrate shall be approved by the Contracting Government of the SOLAS or the Society.
    - \* Refer to the Guidelines for the performance and testing criteria and surveys of low-expansion foam concentrates for fixed fire-extinguishing systems (MSC/Circ.582/Corr.1).
  - (3) The values of the foam expansion and drainage time of the foam produced by the portable foam applicator unit shall not differ more than  $\pm 10\%$  of that determined in (B).
  - (4) The portable foam applicator unit shall be designed to withstand clogging, ambient temperature changes, vibration, humidity, shock, impact and corrosion normally encountered on ships.

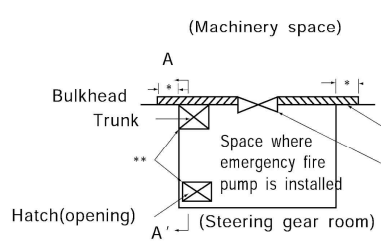
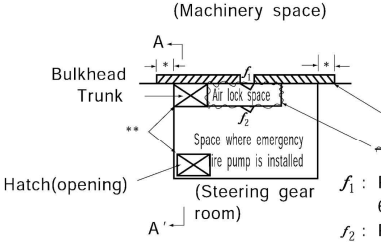
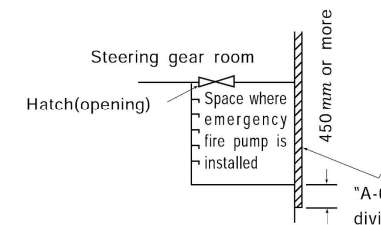
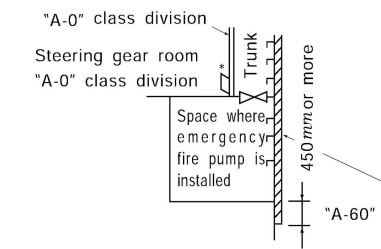
### 202. Arrangement of fire extinguishers [See Rule]

1. Number and arrangement of portable fire extinguishers are to be complied with as follows.
  - (1) If a space is locked when unmanned, portable fire extinguishers required for that space may be kept inside or outside the space.
  - (2) The selection of portable fire extinguishers should be appropriate to the fire hazard(s) in the space in accordance with the Guidelines for marine portable fire extinguishers, as adopted by **Res.A.951(23)**. The classes of portable fire extinguishers in the table are only for reference.
  - (3) Unless expressly provided by the IACS UI SC30, the FSS Code, the FTP Code and related fire test procedures (MSC/Circ. 1120) or **Sec. 4** of the Rules, the number and arrangement of portable fire extinguishers in machinery spaces of category A are specified in **Table 8.8.3** of the Guidance.
2. In applying **202. 2** of the Rules, it is recommended that the remaining portable fire extinguishers in the public spaces and workshops be located at or near the main entrances and exits.

**Table 8.8.3 ( Minimum numbers and distribution of portable fire extinguishers in the various types of spaces on board ships )**

Type of spaces		Minimum number of extinguishers	Class(es) of extinguisher(s) <sup>(6)</sup>
Accommo. spaces	Public spaces	1 per 250 m <sup>2</sup> of deck area or fraction thereof	A
	Corridors	Travel distance to extinguishers should not exceed 25 m within each deck and main vertical zone	A
	Stairway	0	
	Lavatories, cabins, offices, pantries containing no cooking appliances	0	
	Hospital	1	A
Service spaces	Laundry drying rooms, pantries containing cooking appliances	1 <sup>(2)</sup>	A or B
	Lockers and store rooms (having a deck area of 4 m <sup>2</sup> or more), mail and baggage rooms, specie rooms, workshops (not part of machinery spaces, galleys)	1 <sup>(2)</sup>	B
	Galleys	1 class B and 1 additional class F or K for galleys with deep fat fryers	B, F or K
	Lockers and store rooms (deck area is less than 4 m <sup>2</sup> )	0	
	Other spaces in which flammable liquids are stowed	In accordance with <b>Ch 8, 503.</b> of the Rules	
Control stations	Control stations (other than wheelhouse)	1	A or C
	Wheelhouse	2, if the wheelhouse is less than 50 m <sup>2</sup> only 1 extinguisher is required <sup>(3)</sup>	A or C
Machinery spaces of category A	Central control station for propulsion machinery	1, and 1 additional extinguisher suitable for electrical fires when main switchboards are arranged in central control station	A and/or C
	Vicinity of the main switchboards	2	C
	Workshops	1	A or B
	Enclosed space with oil-fired inert gas generators, incinerators and waste disposal units	2	B
	Separately enclosed room with fuel oil purifiers <sup>(7)</sup>	0	
Periodically unattended Machinery spaces of category A	1 at each entrance <sup>(1)</sup>	B	
Other spaces	Workshops forming part of machinery spaces and other machinery spaces (auxiliary spaces, electrical equipment spaces, auto - telephone exchange rooms, air conditioning spaces and other similar spaces)	1	B or C
	Weather deck	0 <sup>(4)</sup>	B
	Ro-ro spaces and vehicle spaces	No point if space is more than 20 m walking distance from an extinguisher at each deck level <sup>(4),(5)</sup>	
	Cargo spaces	0 <sup>(4)</sup>	B
	Cargo pump-room	2	B
Helidecks	In accordance with <b>Ch 11, Sec 4</b> of the Rules	B	

NOTES:

- (1) A portable fire extinguisher required for a small space may be located outside and near the entrance to that space.
- (2) For service spaces, a portable fire extinguisher required for that small space placed outside or near the entrance to that space may also be considered as part of the requirement for the space in which it is located.
- (3) If the wheelhouse is adjacent with a chart room and has a door giving direct access to the chart room, no additional fire extinguisher is required in the chart room. The same applies to safety centres if they are within the boundaries of the wheelhouse in passenger ships.
- (4) Two portable fire extinguishers, each having a capacity of not less than 6 kg of dry powder or equivalent, should be provided when dangerous goods are carried on the weather deck, in open ro-ro spaces and vehicle spaces, and in cargo spaces as appropriate. Two portable fire extinguishers, each having a suitable capacity, should be provided on weather deck for tankers.
- (5) No portable fire extinguisher needs to be provided in cargo holds of containerhips if motor vehicles with fuel in their tank for their own propulsion are carried in open or closed containers.
- (6) Classes of extinguishers are as **Table 8.8.3-1** in accordance with Res.A 951(23)
- (7) The separately enclosed room is to be enclosed by steel bulkheads extending from deck to deck and provided with self-closing steel doors. And, the room is to be provided with independent ventilation system, fire detecting system and fixed fire extinguishing installation.

**Table 8.8.3-1 Class(es) of extinguisher(s)**

International Organization for Standardization (ISO standard 3941)	National Fire Protection Association (NFPA 10)
Class A: Fires involving solid materials, usually of an organic nature, in which combustion normally takes place with the formation of glowing embers.	Class A: Fires in ordinary combustible materials such as wood, cloth, paper, rubber and many plastics.
Class B: Fires involving liquids or liquefiable solids.	Class B: Fires in flammable liquids, oils, greases, tars, oil base paints, lacquers and flammable gases.
Class C: Fires involving gases.	Class C: Fires, which involve energized electrical equipment where the electrical non-conductivity of the extinguishing medium is of importance. (When electrical equipment is de-energized, extinguishers for class A or B fires may be used safely)
Class D: Fires involving metals.	Class D: Fires in combustible metals such as magnesium, titanium, zirconium, sodium, lithium and potassium.
Class F: Fires involving cooking oils.	Class K: Fires involving cooking grease, fats and oils.

## Section 3 Fixed Fire-extinguishing Systems

### 301. Types of fixed fire extinguishing systems

1. In applying **301. 1** (1) of the Rules, fixed gas fire-extinguishing system is also to be complied with as follows. **[See Rule]**
  - (1) Spare parts for the fixed gas fire-extinguishing system specified in Ch 5, 2.1.2.3 of the FSS Code are to be stored on board as below
    - (A) Rupture disc of all containers (including for working rupture disc and packing)
    - (B) Safety disc of 1/3 of all containers (including for working safety disc and packing)
    - (C) Necessary packing, o-ring and tools for maintenance, etc to recharge 1/10 of all containers
  - (2) In applying Ch 5, 2.1.2.6 of the FSS Code, these requirements may be checked by suitable calculations.
  - (3) Fixed gas fire-extinguishing systems for machinery spaces and cargo pump rooms, whose agent containers are stored within the area it protects are to comply with the following requirements.
    - (A) Agent containers stored in a protected space shall be distributed throughout the space with bottles or groups of bottles located in at least six separate locations except the below (C).
    - (B) Duplicate power release lines shall be arranged to release all bottles simultaneously. The release lines shall be so arranged that in the event of damage to any power release line, five sixths of the fire extinguishing gas can still be discharged. The bottle valves are to be considered to be part of the release lines and a single failure shall include also failure of the bottle valve.
    - (C) For systems that need less than six cylinders (using the smallest bottles available), agent containers need not to be distributed separately, provided that
      - (a) The total amount of extinguishing gas on the bottles shall be such that in the event of a single failure to one of the release lines (including bottle valve), five sixths of the fire extinguishing gas than required so that if one bottle is not discharging due to a single fault, the remaining bottles will discharge the minimum five sixths of the required amount of gas. This can be achieved with minimum two bottles.
      - (b) NOAEL(no-observed-adverse-effect-level) valves calculated at the highest expected engine room temperature are not to be exceeded when discharging the total amount of extinguishing gas simultaneously. Systems that can not comply with the above, for instance systems using only one bottle located inside the protected space, can not be accepted. Such systems shall be designed with the bottles located outside the protected space, in a dedicated room in compliance with **303**, of the Rules.
  - (4) In applying Ch 5, 2.2.1.7 of the FSS Code, the "quantity of gas" means that quantity required for the largest cargo space in accordance with the provisions of paragraph 2.1.1.1 of chapter 5. (2018)
  - (5) The requirements in Ch 5, 2.2.2 of the FSS Code apply to the spaces identified in Ch 5, 2.1.3.2 of the FSS Code. Conventional cargo spaces specified in Ch 5, 2.1.3.2 of the FSS Code means cargo spaces other than ro-ro spaces or container holds equipped with integral reefer containers, and they need not be provided with means for automatically giving audible and visual warning of the release.
  - (6) In applying Ch 5, 2.2.3 of the FSS Code, after installation, all pipes are to be tested with working pressure. From main isolating valve to discharge nozzles also should be tested at a pressure of not less than 7 bar.
  - (7) Where a low-pressure CO<sub>2</sub> system is fitted, the piping system is to be designed in such a way that the CO<sub>2</sub> pressure at the nozzles should not be less than 1 N/mm<sup>2</sup>. (2022)
2. In applying **301. 1** (2) of the Rules, fixed foam fire-extinguishing system is also to be complied with as follows. (2018)
  - (1) "Largest protected space" specified in Ch 6, 3.2.1.2 and 3.3.1.2 of FSS Code applies to a machinery space of category A protected by a fixed high-expansion foam fire-extinguishing system complying with the provisions of the FSS Code.
    - (A) Where such a machinery space includes a casing (e.g. an engine casing in a machinery space of category A containing internal combustion machinery, and/or a boiler), the volume of such a casing, above the level up to which foam should be filled to protect the highest position of the fire risk objects within the machinery space, need not be included in the volume of the protected space (see **Fig 8.8.3**).
    - (B) The level up to which foam should be filled to protect the highest positioned fire risk objects

within the machinery space should not be less than:  
 – 1 m above the highest point of any such object; or  
 – the lowest part of the casing, 0  
 whichever is higher (see Fig 8.8.3).

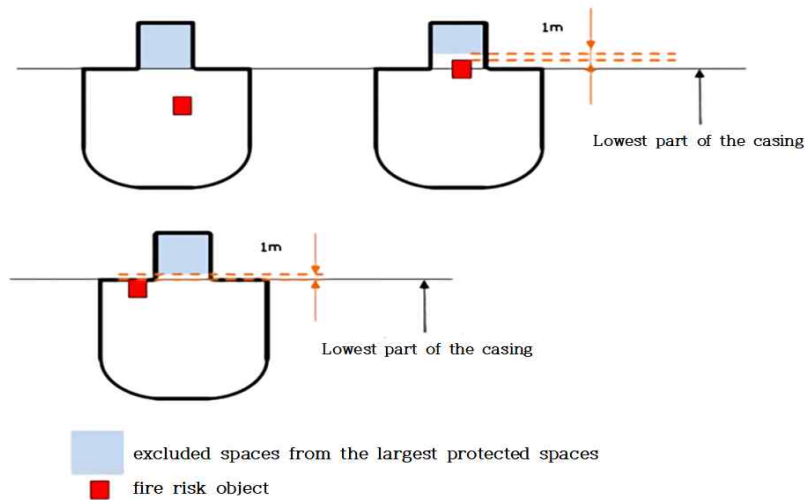

Fig 8.8.3 Machinery space including a casing

- (C) Where such a machinery space does not include a casing, the volume of the largest protected space should be that of the space in its entirety, irrespective of the location of any fire risk object therein (see Fig 8.8.4).
- (D) Fire risk objects include, but may not be limited to, those listed in Ch 1, 103. 31 & 34 of the Rules. Although not referred to in those regulations, they may also include items having a similar fire risk such as exhaust gas boilers or oil fuel tanks.

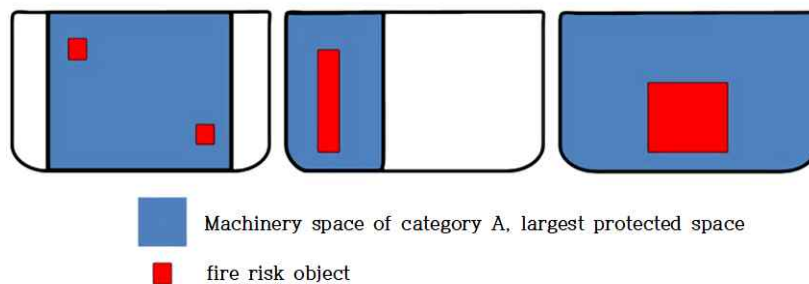

Fig 8.8.4 Machinery space not including a casing

- (B) Fixed high-expansion foam fire-extinguishing system using outside air supply type refers to Fig 8.8.5 of the Guidance and fixed high-expansion foam fire-extinguishing system using inside air type refers to Fig 8.8.6 of the Guidance.

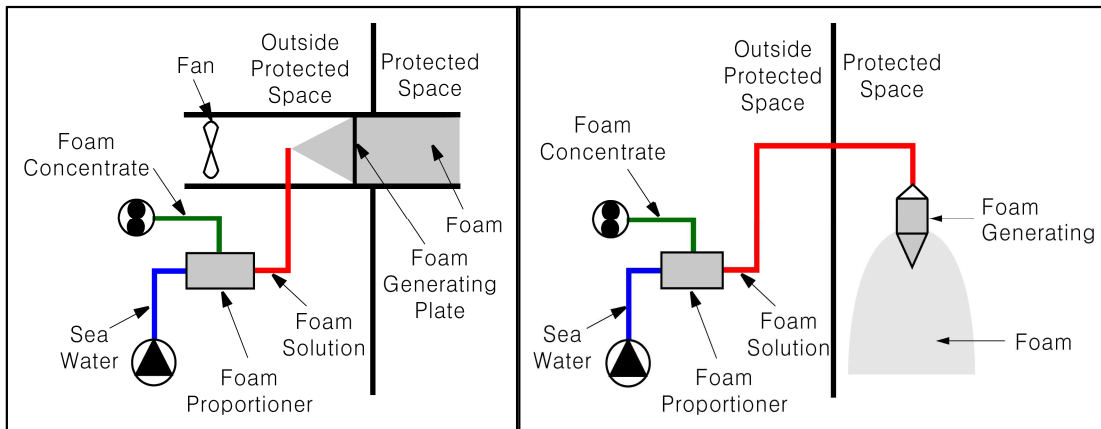

Fig 8.8.5(Outside air supply type)

Fig 8.8.6(Inside air supply type)

3. In applying 301. 1 (3) of the Rules, fixed pressure water-spraying and water-mist fire-extinguishing systems are also to be complied with as follows.

- (1) Fixed pressure water-spraying fire-extinguishing systems & equivalent water-mist fire-extinguishing systems for machinery spaces and cargo pump-rooms shall be approved by the Society based on the Guidelines(MSC/Circ.1165 & MSC.1/Circ.1269, MSC.1/Circ.1386, MSC.1/Circ.1458) developed by the IMO. (2018)
- (2) Fixed pressure water spraying fire-extinguishing systems & equivalent water-mist fire-extinguishing systems for the cabin balconies of passenger ship shall be approved by the Society based on the Guidelines (MSC.1/Circ.1268) developed by the IMO.

### 303. Storage rooms of fire extinguishing medium [See Rule]

Storage room of fire extinguishing medium is used for carbon dioxide fire extinguishing system, Fire-extinguishing media protecting the cargo holds may be stored in a room located forward the cargo holds, but aft of the collision bulkhead, provided that both the local manual release mechanism and remote controls for the release of the media are fitted, and the latter is of robust construction or so protected as to remain operable in case of fire in the protected spaces. The remote controls shall be placed in the accommodation area in order to facilitate their accessibility by the crew. The capability to release different quantities of fire-extinguishing media into different cargo holds so protected shall be included in the remote release arrangement.

## Section 4 Fire Extinguishing Arrangements In Machinery Spaces

### 401. Machinery spaces containing oil-fired boilers or oil fuel units [See Rule]

Fire-extinguishing arrangements in boiler rooms are to be referred to the **Table 8.8.4** of the Guidance. And herein oil fired machinery other than boilers such as fired inert gas generators, incinerators and waste disposal units are to be considered the same as boilers insofar as the required number and type of fire fighting appliances are concerned.

### 402. Machinery spaces of category A containing internal combustion machinery [See Rule]

Fire-extinguishing arrangements in machinery spaces of category A containing internal combustion machinery are to be referred to the **Table 8.8.4** of the Guidance.

Table 8.8.4 Fire-extinguishing arrangements

System, Appliances & extinguishers		Fixed fire-extinguishing system	(1) Portable foam applicator	portable foam extinguisher	Additional portable foam extinguisher	135 L foam extinguisher	(2) 45 L foam extinguisher	(3) sand box
Boiler room	oil-fired boilers	1	1	2N	NA	1(4)	–	N
	oil-fired boilers and oil fuel units	1	1	2N + 2	NA	1(4)	–	N
Engine room	oil fuel units only	1	–	2	NA	–	–	–
	Internal combustion machinery	1	1	x		–	y	–
	Internal combustion machinery and oil fuel units	1	1	x		–	y	–
Boiler room / Engine room	Internal combustion machinery, oil-fired boilers and oil fuel units	1	1	(2N+2) or x whichever is greater		1(4)	y(5)	N

– Notes –  
here in  
N = Number of firing spaces. “2N” means that two extinguishers are to be located in each firing space.  
x = sufficient number, minimum two in each space, so located that there are at least one portable fire extinguisher within 10 m walking distance from any point.  
y = sufficient number to enable foam to be directed onto any part of the fuel and lubricating oil pressure systems, gearing and other hazards.  
(1) may be located at outside of the entrance to the room.  
(2) may be arranged outside of the space concerned for smaller spaces of cargo ships.  
(3) the amount of sand is to be at least 0.1 m<sup>3</sup>. A shovel is to be provided. Sand boxes may be substituted by approval portable fire extinguisher.  
(4) not required for such spaces in cargo ships wherein all boilers contained therein are for domestic services and are less than 175 kW, or boilers are protected by fixed water-based local application fire-extinguishing systems as required by **Ch 8, Sec 4, 406** of the Rules. (2023)  
(5) in case of machinery spaces containing both boilers and internal combustion engines the requirements apply, with the exception that one of the foam fire-extinguishers of at least 45 L capacity or equivalent may be omitted on the condition that the 135 L extinguisher can protect efficiently and readily the area covered by the 45 L extinguisher.

#### 405. Additional requirements for passenger ships [See Rule]

A water fog applicator might consist of a metal L-shaped pipe, the long limb being about 2 m in length capable of being fitted to a fire hose and the short limb being about 250 mm in length fitted with a fixed water fog nozzle or capable of being fitted with a water spray nozzle.

#### 406. Fixed local application fire-fighting systems [See Rule]

1. The fire extinguishing capability of the systems fitted on ships is to be approved by the Society in accordance with the requirements of MSC/Circ.1387. As for fire nozzles they are to be approved by the Flag Administration in which the ship is registered or to be registered in accordance with the requirements of MSC/Circ.1165, as amended by MSC.1/Circ.1269 of IMO. However, in case where there is no expressly provided national regulations, the fire extinguishing capability of the system and nozzles fitted on ship are to be approved by the Contracting Government of the SOLAS or the Society.

#### 2. Principal requirements for the system

(1) System operation

(A) The system is to be capable of manual release.

(B) The activation of the system is not to require engine shutdown, closing fuel oil tank outlet valves, evacuation of personnel or sealing of the space, which could lead to loss of electrical



- power or reduction of maneuverability. This is not intended to place requirements on the electrical equipment in the protected area when the system is discharging freshwater.
- (C) The operation controls are to be located at easily accessible positions inside and outside the protected space. The controls inside the space are not to be liable to be cut off by a fire in the protected areas.
  - (D) Pressure source components of the system are to be located outside the protected areas.
  - (E) Where automatically operated fire fighting systems are installed:
    - (a) a warning notice is to be displayed outside each entry point stating the type of medium used and the possibility of automatic release;
    - (b) the detection system is to ensure rapid operation while consideration is also to be given to preventing accidental release. The area of coverage of the detection system sections is to correspond to the area of coverage of the extinguishing system sections. The arrangements which setup of two approved flame detectors or setup of one approved flame detector and one approved smoke detector are acceptable. Other arrangements can be accepted by the Society. However, use of heat detectors is in general to be avoided for these systems;
    - (c) the discharge of water is to be controlled by the detection system. The detection system is to provide an alarm upon activation of any single detector and discharge if two or more detectors activate. The Society may accept other arrangements; and
    - (d) visual and audible indication of the activated section is to be provided in the engine control room and the navigation bridge or continuously manned central control station. Audible alarms may use a single tone.
  - (F) Operating instructions for the system are to be displayed at each operating position.
  - (G) Appropriate operational measures or inter-locks are to be provided if the engine room is fitted with a fixed high expansion foam or aerosol fire-fighting system, to prevent the local application system from interfering with the effectiveness of these systems.
- (2) Arrangement of nozzles and water supply
- (A) The system is to be capable of fire suppression based on testing conducted in accordance with the appendix to the MSC/Circ.1387 of IMO. Any installation of nozzles on board is to reflect the arrangement successfully tested in accordance with the appendix to the MSC/Circ.1387 of IMO. If a specific arrangement of the nozzles is foreseen on board, deviating from the one tested, it can be accepted provided such arrangement additionally passes fire tests based on the scenarios of the MSC/Circ.1387 of IMO.
  - (B) The location, type and characteristics of the nozzles are to be within the limits tested in accordance with the appendix to MSC/Circ.1387 of IMO. Nozzle positioning is to take into account obstructions to the spray of the fire-fighting system. The use of a single row of nozzles or single nozzles may be accepted for installation where this gives adequate protection according to paragraph 3.4.2.4 of the appendix to MSC/Circ.1387 of IMO.
  - (C) The piping system is to be sized in accordance with a hydraulic calculation technique such as the Hazen-Williams hydraulic calculation technique and the Darcy-Weisbach hydraulic calculation technique, to ensure availability of flows and pressures required for correct performance of the system.
  - (D) The system may be grouped into separate sections within a protected space. The capacity and design of the system are to be based on the section demanding the greatest volume of water. In any case the minimum capacity is to be adequate for a single section protecting the largest single engine, diesel generator or piece of machinery. In multiengine installations, at least two sections are to be arranged.
  - (E) Nozzles and piping are not to prevent access to engine or machinery for routine maintenance. In ships fitted with overhead hoists or other moving equipment, nozzles and piping is not to be located to prevent operation of such equipment.
- (3) System components
- (A) The system is to be available for immediate use and capable of continuously supplying water based medium for at least 20 min in order to suppress or extinguish the fire and to prepare for the discharge of the main fixed fire extinguishing system within that period of time.
  - (B) The system and its components are to be suitably designed to withstand ambient temperature changes, vibration, humidity, shock, impact, clogging and corrosion normally encountered in machinery spaces. Components within the protected spaces are to be designed to withstand the elevated temperatures which could occur during a fire. Components are to be tested in accordance with the listed sections of appendix A of MSC/Circ.1165, as amended by MSC.1/Circ.1269.

- (C) The system and its components are to be designed and installed based on international standards acceptable to the Society, and manufactured and tested in accordance with the appropriate elements of the appendix to MSC/Circ.1387 of IMO.
- (D) The electrical components of the pressure source for the system are to have a minimum rating of IPX4 if located in the protected space. Systems requiring an external power source need only be supplied by the main power source.
- (E) The water supply for local application systems may be fed from the supply to a water based main fire fighting system, providing that adequate water quantity and pressure are available to operate both systems for the required period of time. Local application systems may form a section(s) of a water based main fire extinguishing system provided that all requirements of **404**. of the Rules, IMO MSC/Circ.1387 and MSC/Circ.1165 (including amendments made by MSC.1/Circ.1237, MSC.1/Circ.1269 and MSC.1/Circ.1386) are met. And the systems are capable of being isolated from the other sections of the main system.
- (F) A means for testing the operation of the system for assuring the required pressure and flow is to be provided.
- (G) Spare parts and operating and maintenance instructions for the system are to be provided as recommended by the manufacturer.
- (H) A fitting is to be installed on the discharge piping of open head systems to permit blowing air through the system during testing to check for possible obstructions.

**3. Installation of electrical and electronic equipment in engine rooms protected by fixed water-based local application fire-fighting systems (FWBLAFFS) (2019)**

- (1) The protected spaces are to apply as follows, (See also **Fig 8.8.7** of the Guidance)
  - (A) The protected spaces means a machinery space where a local application fire-fighting system is installed.
  - (B) The protected areas means an area (an installation or part of an installation) within a protected space which is required to be protected by local application fire-fighting system.
  - (C) The adjacent areas means areas other than protected areas exposed to direct spray and areas other than those defined above where water may extend.
- (2) The activation of the fire-extinguishing system should not result in loss of electrical power or reduction of the maneuverability of the ship. Electrical and electronic equipment enclosures located within areas protected by fixed water-based local application fire-fighting systems (FWBLAFFS) and those within adjacent areas exposed to direct spray are to have a degree of protection not less than IP44, except where evidence of suitability is submitted to and approved by the Society. Electrical and electronic equipment within adjacent areas not exposed to direct spray may have a lower degree of protection provided evidence of stability for use in those areas is submitted taking into account the design and equipment lay out, e.g. position of inlet ventilation openings, cooling airflow for the equipment are to be assured.

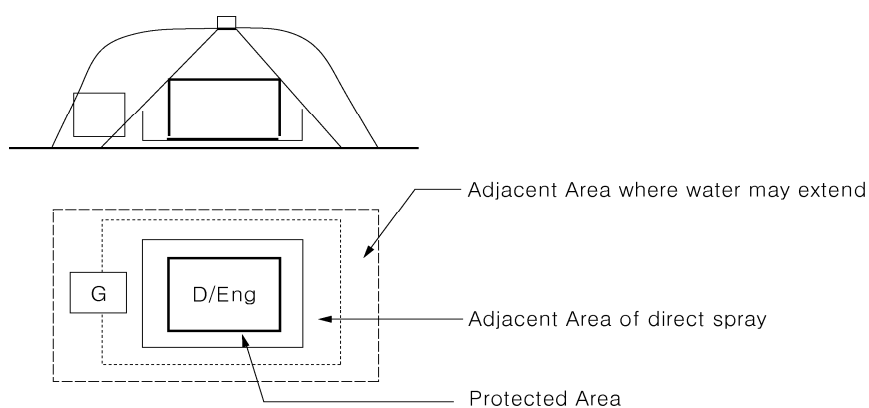

**Fig 8.8.7 Protected areas**

## Section 5 Fire-extinguishing Arrangements In Control Stations, Accommodation and Service Spaces

### 501. Sprinkler and water spray systems in passenger ships

In applying **501. 1** of the Rules, heat detectors are acceptable in refrigerated chambers and in other spaces where steam and fumes are produced such as saunas and laundries. And dry pipe sprinkler systems are acceptable in refrigerated chambers. **[See Rule]**

### 503. Spaces containing flammable liquid

In applying **503. 2 & 3** of the Rules, these requirements given are not considered applicable for cargo service spaces intended for the stowage of cargo samples, when such spaces are positioned within cargo area onboard tankers. **[See Rule]**

### 504. Deep-fat cooking equipment **[See Rule]**

1. In applying **504.** of the Rules, deep-fat cooking equipment means, in general, a fixed type cooking appliance in which cooking greases in depth are used. (2018)
2. In applying **504. 1** of the Rules, an international standard acceptable to the IMO means ISO 15371 or equivalent. (2018)

## Section 6 Fire-extinguishing Arrangements In Cargo Spaces

### 601. Fixed gas fire-extinguishing systems for general cargo (2018) **[See Rule]**

1. The fire-fighting system for coal carriers is to comply with these requirements.
  - (1) Wiring and electrical equipment fitted in cargo holds, spaces having direct openings to cargo holds and zones within 3 m from ventilating openings of cargo holds are to comply with the requirements of electrical equipment for coal carriers in **Pt 7, Ch 3, Sec 16** of the Rules.
  - (2) Portable instruments to measure the atmosphere (densities of methane, oxygen and carbon monoxide) of upper parts in cargo holds are to be provided, and two restricted measuring holes (penetrating the walls and in use, permitting a small quantity of cargo vapour to be exposed to the atmosphere, but when not in use, completely closed) per hold, each both port and starboard sides of the hatch cover, are to be provided.
  - (3) Two self-contained breathing apparatuses required by **901.** of the Rules are to be provided, without no requirement of additional ones.
  - (4) Prohibition of arrangements adjacent to hot areas shall satisfy the following requirements.
    - (A) Hot areas of steam piping, exhaust gas piping, heaters, etc. in machinery spaces adjacent to cargo holds are to be separated as appropriate distances so as not to adjoin the cargo holds.
    - (B) In case where a bunker tank is provided in machinery spaces adjacent to cargo holds, heating coils are to be fitted so as not to adjoin the cargo holds as practicable, and appropriate measurements generally not exceeding 50 °C are to be taken.
    - (C) Heating coils in lubricating oil tanks adjacent to cargo holds are to be treated as same as the requirement of (B) above.
    - (D) In case where oil fuel systems of ships using oil fuel of low quality are fitted adjacent to cargo holds, their oil fuel tanks, in principle, are not to adjoin the cargo holds because of the higher normal operation temperature than limited temperature, but when avoidably fitted, appropriate measurements to prevent the temperature of bulkheads of cargo holds exceeding limited temperature are to be taken.
    - (E) In case where heating coils of tanks and their related equipment are provided so as not to exceed limited temperature, the Society may permit exemption from the requirements of (A), (B), (C) or (D) above in consideration of the data.
2. In applying **601. 3** of the Rules, ships of less than 2.000 tons gross tonnage carrying petroleum products having a flash point exceeding 60 °C (closed cup test) are not required to be fitted with a fixed fire extinguishing system. And the cargoes for which a fixed gas fire-extinguishing system is ineffective and for which a fire-extinguishing system giving equivalent protection should be available,

are aluminium nitrate, ammonium nitrate, ammonium nitrate fertilizers, barium nitrate, calcium nitrate, lead nitrate, magnesium nitrate, potassium nitrate, sodium nitrate, Chilean natural nitrate, sodium nitrate and potassium nitrate mixture, and Chilean natural potassic nitrate.

3. In applying **601. 4** of the Rule, "cargoes which constitute a low fire risk" means that all cargoes listed in appendix 1, entry for coal of the IMSBC Code and the lists of solid bulk cargoes for which a fixed gas fire-extinguishing system may be exempted or for which a fixed gas fire-extinguishing system is in effective **(the latest version of MSC.1/Circ.1395)**. (2022)

#### **602. Fixed gas fire-extinguishing systems for dangerous goods [See Rule]**

In applying **601. 4** of the Rules, all cargo ships, are to be applied the requirement, engaged in the carriage of dangerous goods, of 500 tons gross tonnage and above. And water supplies defined in **Ch 12, 201. 1 (2)** of the Rules are considered as acceptable protection for cargoes listed in Table 2 of the latest version of **MSC.1/Circ.1395** (2022)

#### **603. Firefighting for ships designed to carry containers on or above the weather deck**

1. In applying **603. 2** of the Rules, in cases where the mobile water monitors are supplied by separate pumps and piping system, the total capacity of the main fire pumps need not exceed 180 m<sup>3</sup>/h and the diameter of the fire main and water service pipes (hereinafter referred to "the pipework diameter") need only be sufficient for the discharge of 140 m<sup>3</sup>/h. (2018) **[See Rule]**
2. In applying **603. 2** of the Rules, in cases where the mobile water monitors are supplied by the main fire pumps; the total capacity of required main fire pumps and the pipework diameter should be sufficient for simultaneously supplying both the required number of fire hoses and mobile water monitors. However, the total capacity should not be less than the following (1) or (2), whichever is smaller: (2018)
  - (1) four thirds of the quantity required under SOLAS Reg. II-1/35-1 to be dealt with by each of the independent bilge pumps in a passenger ship of the same dimension when employed in bilge pumping; or
  - (2) 180 m<sup>3</sup>/h.
3. In applying **603. 2** of the Rules, on board cargo ships designed to carry five or more tiers of containers on or above the weather deck, the total capacity of the emergency fire pump need not exceed 72 m<sup>3</sup>/h.
4. Refer to the Guidelines for the design, performance, testing and approval of mobile water monitors used for the protection of on-deck cargo areas of ships designed and constructed to carry five or more tiers of containers on or above the weather deck (MSC.1/Circ.1472).

## **Section 7 Cargo Tank Protection**

#### **701. Fixed deck foam systems [See Rule]**

Fixed deck foam systems is also to be complied as follows.

1. In applying Ch 14, 2.1.2 of the FSS Code, the major equipment such as the foam concentrate tank and the pump may be located in the engine room.
2. In applying Ch 14, 2.1.3 of the FSS Code, where the deck foam system is supplied by a common line from the fire main, a common line for fire main and deck foam line can only be accepted provided it can be demonstrated that the hose nozzles can be effectively controlled by one person when supplied from the common line at a pressure needed for operation of the monitors.
3. In applying Ch 14, 2.3.2.3 of the FSS Code, the port and starboard monitors required may be located in the cargo area above oil bunker tanks adjacent to cargo tanks if capable of protecting the deck below and aft of each other. (2022)
4. Where an enclosed pipe trunk is situated within the cargo tanks deck area, the pipe trunk:
  - (1) should be protected by a fixed fire-extinguishing system in accordance with **801.** of the Rules.

The extinguishing system should be operated from a readily accessible position outside the pipe trunk;

- (2) is not considered part of the cargo tanks deck area;
- (3) The area of the pipe trunk need not be included in the calculation of the foam solution rate of supply for the deck foam system required by **701.** of the Rules.;
- (4) should be adequately ventilated and protected in accordance with **Ch 2, 410. 2, 3** of the Rules.;
- and
- (5) should contain no flammable gas sources other than pipes and flanges. If the pipe trunk contains any other source of flammable gas, i.e. valves and pumps, it should be regarded as a cargo pump-room.

## Section 8 Protection of Cargo Pump Room

### 801. Protection of cargo pump room [See Rule]

1. In tankers carrying flammable high pressure gases, in addition, two portable carbon dioxide extinguishers or dry powder extinguishers are to be provided, one at the pumps and one at the pump room entrance. Instruments monitoring gas in any space where flammable high pressure gas is able to leak are to be fitted.
2. In applying **801. 1** of the Rules, the audible alarms are to be safe for use in a flammable cargo vapour/air mixture, and may be of the pneumatic type or electric type complying with the following requirements.
  - (1) In cases where the periodic testing of pneumatically operated alarms is required, CO<sub>2</sub> operated alarms are not to be used owing to the possibility of the generation of static electricity in the CO<sub>2</sub> cloud. Air operated alarms may be used, provided the air supply is clean and dry.
  - (2) When electrically operated alarms are used, the arrangements are to be such that the electric actuating mechanism is located outside the pump room except where the alarms are certified intrinsically safe.

## Section 9 Fire-fighter's Outfit

### 901. Types of fire-fighter's outfits [See Rule]

1. A fire-fighter's outfit is also to be complied with the following requirements.
  - (1) Protective clothing: Reference is made to ISO standard 6942.
  - (2) Boots of rubber or other electrically non-conducting material: Reference is made to IEC 60903.
  - (3) Electric safety lamp on tankers and those intended to be used in hazardous areas shall be of an explosion-proof type: Reference is made to IEC 60079.
  - (4) In applying Ch 3, 2.1.2.2 of the FSS Code, requires an audible alarm and a visual or other device which will alert the user. In this context, a pressure indicator, with which the user can read that the volume of remaining air in the cylinder has been reduced to no less than 200 L, regardless of the need for supplemental lighting, may be regarded as a "visual device". (2018)

### 904. Fire-fighter's communication [See Rule]

1. Two-way portable radiotelephone apparatus for fire-fighter's communication required by **904.** of the Rules should be of certified safe type suitable for use in zone 1 hazardous areas, as defined in IEC Publication 60079. Certified safe type means electrical equipment that is certified safe by the relevant authorities recognized by the Society for operation in a flammable atmosphere based on a recognized standard ( IEC 60079 series and IEC 60092-502). The minimum requirements in respect to the apparatus group and temperature class are to be consistent with the most restrictive requirements for the hazardous area zone on board which is accessible to fire party. (2020) ↓

## CHAPTER 9 STRUCTURAL INTEGRITY

### Section 1 Material

#### 101. Material of hull, superstructures, structural bulkheads, decks and deckhouses [See Rule]

Deckhouses, boatswain's stores, etc. which are independently arranged away from a group of accommodation spaces may be regarded as independent service spaces respectively. Accordingly, internal divisions in these spaces may be of "C" class standard. Accordingly, access hatches to under deck spaces (for example, cargo space) from these spaces may be weathertight. Access hatches to the under deck spaces from other machinery spaces having little risk of fire which are independently arranged away from a group of accommodation spaces, may also be weathertight. And stairs in control stations, accommodation and service spaces are to be of steel or equivalent materials.

### Section 2 Structure of aluminium alloy

#### 201. Structure of aluminium alloy

1. In applying 201.1 of the Rules, "structure which is non-load bearing" means partition walls. [See Rule]
2. If an aluminium deck is tested with insulation installed below the deck, then the result will apply to decks which are bare on the top in accordance with the FTP code Annex 1 Part 3 4.3.
3. The use of aluminium coatings is prohibited in cargo tanks, cargo tank deck area, pump room, cofferdams or any other area where cargo vapour may accumulate.
4. However, aluminized pipes may be permitted in ballast tanks, in inerted cargo tanks and, provided the pipes are protected from accidental impact, in hazardous area on open deck.

### Section 3 Machinery Spaces of Category A

#### 301. Machinery spaces of category A

Crowns and casings exposed to the open air need not be insulated. [See Rule]

### Section 4 Materials of Overboard Fittings

#### 401. Materials of overboard fittings [See Rule]

The parts where the use of materials readily rendered ineffective by heat (PVC, FRP, aluminium alloys, lead, copper and copper alloys) is prohibited for overboard scuppers and sanitary discharges are to be in accordance with the following requirements:

1. The parts of pipes for scuppers below the freeboard deck and sanitary discharges having open ends on the shell plating below the freeboard deck (see Fig 8.9.1 (a) of the Guidance).
2. In case where scuppers and sanitary discharges having open ends on the shell plating above the freeboard deck with their lower edges located at 150 mm or less above the load line, the parts of pipes in the spaces having such openings (see Fig 8.9.1 (b) of the Guidance).
3. In case 1. above, if the distance between the freeboard deck and the load line is 150 mm or less, the requirements are also to apply to the parts of pipes in the spaces directly above the freeboard deck (see Fig 8.9.1 (c) of the Guidance).

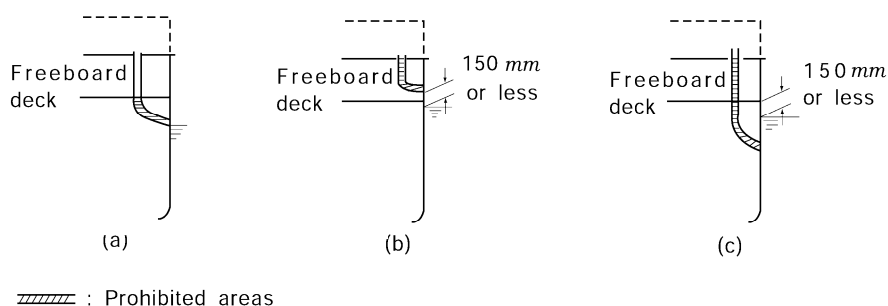

Fig 8.9.1 Areas prohibited from using materials readily rendered ineffective by heat

## Section 5 Protection of Cargo Tank Structure Against Pressure Or Vacuum In Tankers

### 501. General

In applying **501. 1** of the Rules, the pressure setting, installation, tests and marking of "Pressure/Vacuum valve" are to be in accordance with following requirements. The Pressure/Vacuum valve is to be type approved by this Society. **【See Rule】**

#### 1. Pressure setting

Pressure/Vacuum valves are to be set at a pressure within the range from 21 kPa to 14 kPa on the pressure side and 3 kPa to 7 kPa on the vacuum side. provided, however, that special re-inforcements are made for the scantlings of cargo tanks, the set pressure on the pressure side may be of an appropriate value not exceeding 70 kPa.

#### 2. Installation

- (1) In case where a Pressure/Vacuum valve is fitted on a vent branch pipe of the common venting system, the discharge outlet and the suction inlet are to be separated. The suction inlet is not to be fitted to the vent branch pipe to the cargo tanks.
- (2) Means are to be provided for easy access to the valves.

#### 3. Tests and inspection

- (1) The tests and inspection for the individual product are to be carried out in accordance with followings.
  - (A) Construction inspection
  - (B) Hydraulic test
  - (C) Confirmation of the pressure at which the valve opens and closes
- (2) On board test  
It is to be ascertained by a suitable method that the Pressure/Vacuum valves can be operable smoothly after installed on board.

#### 4. Test report

A test report for each finished device is to be prepared. This is to include followings.

- (1) detailed drawings of the device and its components
- (2) the types of test conducted and the results obtained, with all recorded data
- (3) specific advice on approved attachments
- (4) drawings of the test rig, to include a description of the inlet and outlet piping attached
- (5) a record of all markings(refer to **6**) found on the device tested
- (6) a report number

#### 5. Instruction manual

The manufacturer is to provide an instruction manual for each device. The instruction manual is to include the following items;

- (1) Installation instructions
- (2) Operating instructions, including information on the lowest MESH that the device is suitable for, if fitted with a flame screen or with a high-velocity vent. The instructions are to also include any service restrictions imposed for safe functioning of the device, including requirements imposed for the proper installation of the device
- (3) Maintenance requirements, including information on maintenance of any corrosion protection system
  - (A) Instructions on how to determine when device cleaning is required and the method of cleaning. Where the manufacturer allows valve overhauls to be performed by the user, the manufacturer is to provide the necessary procedures, instructions and diagrams for the valve to be restored to original, as-purchased condition with regard to set pressure and flow rate
  - (B) Instructions on the frequency of cleaning of the device to remove vapour condensate. The frequency of cleaning condensate residue from the valve will vary depending on the cargo
  - (C) Instruction clearly defining the method of setting the pressure, including information such as dismantling and reassembling the valve, numbering and ordering information, and diagrams for proper assembly of items
  - (D) Instructions to check valve lift by the user prior to each cargo loading and cargo unloading operation
  - (E) Instructions to conduct a complete inspection of the valve and the recommended frequency
- (4) The test report described in 4.
- (5) Flow test data, including flow rates under both positive and negative pressures, operating sensitivity, flow resistance, velocity and maximum pipe length on the inlet side
- (6) The manufacturer's certification that the device has been constructed and tested in accordance with this International Standard

## 6. Marking

Each device is to be permanently marked indicating followings.

- (1) manufacturer's name or trademark
- (2) style, type, model or other manufacturer's designation for the device, which is to form a unique identification of the device
- (3) size of the inlet (and outlet, if applicable)
- (4) serial number
- (5) direction of flow through the device
- (6) test laboratory and report number
- (7) pressure and vacuum setting
- (8) the reference number of this International Standard

## 7. Combination type Pressure/Vacuum valve

In case where an exclusive automatic pressure valve and an exclusive automatic vacuum valve are provided in combination, such an arrangement may be regarded as to be provided with a Pressure/Vacuum valve. In this case, the exclusive automatic pressure valve and the exclusive automatic vacuum valve are to comply with the requirements for the discharge side or the suction side of the Pressure/Vacuum valves specified in 1 and 2 respectively.

### 502. Openings for small flow by thermal variations (2023) [See Rule]

Area Classification is to be carried out in accordance with the principles laid down in IEC 60092-502:1999 and the classes of hazardous areas are to be referred to Pt 7, Ch 1, 1101. 2 of the Rules.

- (1) Areas on open deck, or semi-enclosed spaces on open deck, within 3m of cargo tank ventilation outlets which permit the flow of small volumes of vapour or gas mixtures caused by thermal variation are defined as **Zone 1** as specified by IEC 60092-502:1999 para 4.2.2.7.
- (2) Areas within 2m beyond the zone specified in (1) above are to be considered Zone 2 (as opposed to 1.5m as specified by IEC 60092-502:1999 para 4.2.3.1).
- (3) Electrical equipment or cables shall not normally be installed in hazardous areas. Where essential for operational purposes, electrical equipment may be installed in accordance with IEC 60092-502:1999.



### 503. Safety measures in cargo tanks

1. In applying **503. 2** of the Rules, a P/V breaker fitted on the IG main may be utilized as the required as the required secondary means of venting. Where the cargo is homogenous or for multiple cargoes where the vapours are compatible and do not require isolation. The height requirements of **Ch 2, 403. 4 & 502.** of the Rules and the requirements for devices to prevent the passage of flame of **Ch 2, 403. 3** are not applicable to the P/V breaker provided the settings are above those of the venting arrangements required by **501.** of the Rules. Where the venting arrangements are of the free flow type and the masthead isolation valve is closed for the unloading condition, the IG systems will serve as the primary underpressure protection with the P/V breaker serving as the secondary means. **【See Rule】**
2. Inadvertent closure or mechanical failure of the isolation valves required by **Ch 2, 403. 2 (2)** of the Rules & **Annex 8-5, 2 (10) (B)** need not be considered in established the secondary means where the cargo is homogenous or for multiple cargoes where the vapours are compatible and do not require isolation since the valves are operated under control of the responsible ships officer and a clear visual indication of the operational status of the valves, and the possibility of mechanical failure of the valves is remote to their simplicity.
3. For ships that apply pressure sensors in each tank as an alternative secondary means of venting as per **503. 2** of the Rules, the setting of the over-pressure alarm is to be above the pressure setting of the P/V-valve and the setting of the under-pressure alarm is to be below the vacuum setting of the P/V-valve. The alarm settings are to be within the design pressures of the cargo tanks. The settings are to be fixed and not arranged for blocking or adjustment in operation. An exception is permitted for ships that carry different types of cargo and use P/V valves with different settings, one setting for each type of cargo. The settings may be adjusted to account for the different types of cargo.

### 504. Size of vent outlets **【See Rule】**

Together with IBC code and IGC code where areas on open deck, or semi-enclosed spaces on open deck, within a vertical cylinder of unlimited height and 6 m radius centred upon the center of the outlet, and within a hemisphere of 6 m radius below the outlet which permit the flow of large volume of vapour, air or inlet gas mixtures during loading/discharging/ballasting are defined Zone 1, electrical equipment shall be certified safe type equipments. And then areas within 4 m beyond zone 1 are defined as Zone 2 in which electrical equipment shall be of the following requirements.

- (1) Certified safe type equipment for Zone 1,
- (2) Equipment of a type, which ensure the absence of sparks, arcs and of "hot spots" during its normal operation,
- (3) Equipment having an enclosure filled with a liquid dielectric, when required by the application, or encapsulated,
- (4) Pressurized equipment,
- (5) Equipment specifically designed for Zone 2(for example type "n" protection in accordance with IEC 60079-15. ↓

## CHAPTER 10 ESCAPE

### Section 2 Means of escape

#### 201. General requirements [See Rule]

1. To facilitate a swift and safe means of escape to the lifeboat and liferaft embarkation deck, the following provisions apply to overhead hatches fitted along the escape routes addressed by this section of Rules.
  - (1) The securing devices are to be of a type which can be opened from both sides;
  - (2) The maximum force needed to open the hatch cover is not to exceed 150 N; and
  - (3) The use of a spring equalizing, counterbalance or other suitable device on the hinge side to reduce the force needed for opening is acceptable.

#### 202. Means of escape from control stations, accommodation and service spaces

1. In application to **202. 1. (3)** of the Rules, the term "where the Society sanctions the use of other equivalent material" means those complying with the requirements specified in **Ch 1, 103. 43** of the Rules, etc. [See Rule]
2. In applying **202. 1 (4)** of the Rules, two means of escape from the radio room are to be those which are separated each other and the escape routes are not common. [See Rule]
3. In applying **202. 1 (5)** of the Rules, in case of a conflict with the requirements of ICLL Annex I Reg.12(2), the requirements of ICLL Annex I Reg.12(2) is to be applied first. (2017) [See Rule]
4. In applying **202. 2 (4) (E)** of the Rules, indication of the assembly station in passenger ships refers to **MSC/Circ.777**. [See Rule]
5. In applying **202. 2 (5) (A)** of the Rules, lighting or photoluminescent strip indicators shall comply with **IMO Res. A.752(18)** and **ISO 15370**. [See Rule]
6. In applying **202. 2 (5) (C)** of the Rules, "guidelines developed by the IMO" mean **MSC/Circ.1167** and **MSC/Circ.1168**. [See Rule]
7. In applying **202. 2 (7)** of the Rules, evacuation analysis for passenger ships refers to **MSC.1/Circ. 1533**. (2019) [See Rule]
8. In applying **202. 3** of the Rules, the means of escape is, in principle, to be comply with as follows : [See Rule]
  - (1) Openings for escape are to be not less than 600 mm × 400 mm for Manhole (including window), 600 mm × 600 mm for Small hatch(in square) and  $f$  600 mm for Small hatch(in circle).
  - (2) The embarkation deck is to be accessible from the open decks to which escape routes lead.
  - (3) The means of escape may be accepted even where lifeboats and liferafts area can not directly be reached, provided that such area can be reached through corridors and stairways in normal ways. Such arrangement as to reach the area only by passing through the cabins or using vertical ladders is not to be accepted.
  - (4) Stairways and corridors used as means of escape shall be not less than 700 mm in clear width and shall have a handrail on one side. Stairways and corridors with a clear width of 1,800 mm and over shall have handrails on both sides. "Clear width" is considered the distance between the handrail and the bulkhead on the other side or between the handrails.
  - (5) The angle of inclination of stairways should be, in general, 45° but not greater than 50° and in machinery spaces and small spaces not more than 60° Doorways which give access to a stairway shall be of the same size as the stairway.
9. In applying **202. 3 (2)** of the Rules, the means of second escape is to be either stairway which directly leads to open deck from the place concerned or hatch capable of being operated from both sides.
10. In applying **202. 3 (3)** of the Rules, the following requirements shall be complied with :
  - (1) In case where two stairways protected by the divisions are provided, doors allowing to escape directly from at least two decks from where the lifeboats and liferafts area can be easily

reached are to be provided on both sides (see Fig 8.10.1 (a) of the Guidance).

- (2) In case where only one stairway protected by the divisions is provided, at least one door through which direct escape to the open deck is possible, is to be provided on each deck (see Fig 8.10.1 (b) of the Guidance).

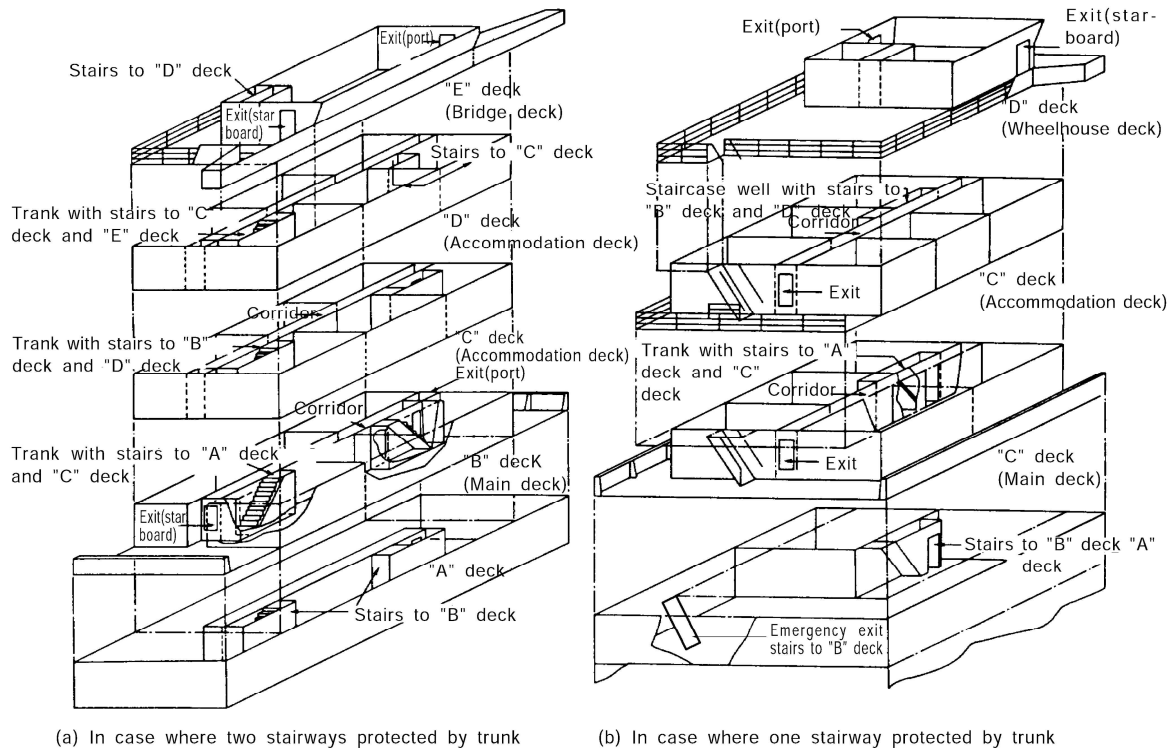

Fig 8.10.1 Means of Escape

11. In applying 202. 3 (2) & (3) of the Rules, the "Lowest open deck" should be a category ⑩ "Open deck" (as defined in Ch 7 103. 3 (2) (B) & 104. 2 (2) (B) of the Rules) at the lowest height from baseline in way of accommodation spaces.
12. In applying 202. 3 (4) of the Rules, dead-end corridors, which they can not be avoided, are to be so designed that persons do not easily enter such corridors in cases of emergency.
13. In applying 202. 4 (1) of the Rules, Emergency escape breathing devices (EEBD) shall satisfy the following requirements. **[See Rule]**
  - (1) An EEBD is a supplied-air or oxygen device only used for escape from a compartment that has a hazardous atmosphere and shall be of an approved type.
  - (2) EEBDs shall not be used for fighting fires, entering oxygen deficient voids or tanks, or worn by fire-fighters. In these events, a self-contained breathing apparatus, which is specifically suited for such applications, shall be used.
  - (3) Face piece means a face covering that is designed to form a complete seal around the eyes, nose and mouth which is secured in position by a suitable means.
  - (4) Hood means a head covering which completely covers the head, neck, and may cover portions of the shoulders.
  - (5) Hazardous atmosphere means any atmosphere that is immediately dangerous to life or health.
  - (6) The EEBD shall have a service duration at least 10 minutes.
  - (7) The EEBD shall include a hood or full face piece, as appropriate, to protect the eyes, nose and mouth during escape. Hoods and face pieces shall be constructed of flame resistant materials and include a clear window for viewing.
  - (8) An inactivated EEBD shall be capable of being carried hands-free.
  - (9) An EEBD, when stored, shall be suitably protected from the environment.
  - (10) Brief instructions or diagrams clearly illustrating their use shall be clearly printed on the EEBD.

The donning procedures shall be quick and easy to allow for situations where there is little time to seek safety from a hazardous atmosphere.

- (11) Maintenance requirements, manufacturer's trademark and serial number, shelf life with accompanying manufacture date and name of approving authority shall be printed on each EEBD. All EEBD training units shall be clearly marked.

### 203. Means of escape from machinery spaces

1. In applying **203. 1** and **2** of the Rules, the means of escape to the open deck from machinery spaces of category A shall satisfy the following requirements. **【See Rule】**
  - (1) One of the means of escape required by the Rules is to be arranged as follows:
    - (A) It is to be enclosed and insulated as required for spaces of the Rules against the space it serves. Ladders are to be fixed in such a way that heat cannot, in case of a fire in the machinery space, be transferred to the ladder through non-insulated fixing points;
    - (B) The self-closing door is to have the fire integrity of the bulkhead in which it is fitted. If there are other exits to this trunk they are also to be provided with such doors;
  - (2) It is not desirable to use ro-ro spaces or vehicle spaces as a part of the escape routes from machinery space of category A to the open deck. In case where such arrangement is unavoidable, the following requirements shall be satisfied:
    - (A) The escape route through ro-ro spaces or vehicle spaces is to be restricted to one, and other routes are to be arranged either through spaces other than the above route or through enclosed escape trunks. The trunks are to be applied with insulation in accordance with the requirements of the Rules, as corridors.
    - (B) The escape route through ro-ro spaces and vehicle spaces is to be as short as possible, and a corridor is to be secured by the permanent and strong construction so that passage may not be hampered by cargo.
  - (3) Insulation of the shelter is to be taken as equivalent to that of the passage way or lobby and be in compliance with **Table 8.7.1** to **8.7.8** of the Rules.
  - (4) In case where only one set of means of escape other than the shelter for machinery spaces of category A is provided, self-closing doors required at the lower part of the shelter are to be provided at each deck level.
  - (5) "Ladder" means stairways and ladders. Ladders having strings of flexible steel wire ropes are not acceptable in such escape routes.
2. In applying **203. 2** (3) of the Rules, for machinery spaces which are regarded as those having little or no fire risk, machinery spaces in which the crew is not normally employed, or small spaces, only one set of means of escape may be provided. In this case, however, the escape route is not to pass through machinery spaces of category A. Where shaft tunnel is provided, an escape route is to be provided aft of the shaft tunnel (see **Fig 8.10.3** of the Guidance). **【See Rule】**

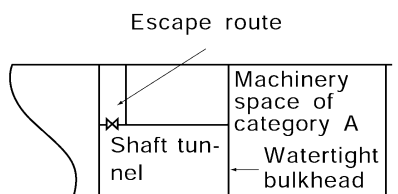

**Fig 8.10.3** Escape of small spaces

3. In applying **203. 3** of the Rules, the minimum quantity of emergency escape breathing devices is to be as follows: **【See Rule】**
  - (1) In machinery spaces for category A containing internal combustion machinery used for main propulsion
    - (A) one (1) EEBD in the engine control room, if located within the machinery space;
    - (B) one (1) EEBD in workshop areas. If there is, however, a direct access to an escape way from the workshop, an EEBD is not required; and
    - (C) one (1) EEBD on each deck or platform level near the escape ladder constituting the second

means of escape from the machinery space (the other means being an enclosed escape trunk or watertight door at the lower level of the space).

- (2) For machinery spaces of category A other than those containing internal combustion machinery used for main propulsion, one (1) EEBD should, as a minimum, be provided on each deck or platform level near the escape ladder constituting the second means of escape from the space (the other means being an enclosed escape trunk or watertight door at the lower level of the space).
  - (3) Where the requirements of flag state are different from (1) and (2), the requirements of flag state are to be applied.
4. In applying **203. 3 (3)** of the Rules, emergency escape breathing devices (EEBD) are to be complied with 202. 12 requirements of the Guidance. (2017)
5. In applying **203. 1 & 2** of the Rules, the following requirements are to be applied.
- (1) Inclined ladders/stairways in machinery spaces being part of, or providing access to, escape routes but not located within a protected enclosure should not have an inclination greater than 60° and should not be less than 600 mm in clear width.  
Such requirement need not be applied to ladders/stairways not forming part of an escape route, only provided for access to equipment or components, or similar areas, from one of the main platforms or deck levels within such spaces.
  - (2) Internal dimensions should be interpreted as clear width, so that a passage having diameter of 800 mm is available throughout the vertical enclosure, as shown in **Fig 8.10.4** of the Guidance, clear of ship's structure, with insulation and equipment, if any. The ladder within the enclosure can be included in the internal dimensions of the enclosure.  
When protected enclosures include horizontal portions their clear width should not be less than 600 mm. **Fig 8.10.4** of the Guidance is given as example of some possible arrangements which may be in line with the above interpretation.
6. In applying **203. 1 (1), (4) and (6)** of the Rules, the following requirements are to be applied.
- (1) A "safe position" can be any space, excluding lockers and storerooms irrespective of their area, cargo spaces and spaces where flammable liquids are stowed, but including special category spaces and ro-ro spaces, from which access is provided and maintained clear of obstacles to the embarkation decks.
  - (2) Machinery spaces may include working platforms and passageways, or intermediate decks at more than one deck level. In such case, the lower part of the space should be regarded as the lowest deck level, platform or passageway within the space. Smaller working platforms in-between deck levels, or only for access to equipment or components, need not be provided with two means of escape.
  - (3) A protected enclosure providing escape from machinery spaces to an open deck may be fitted with a hatch as means of egress from the enclosure to the open deck. The hatch should have minimum internal dimensions of 800 mm x 800 mm.

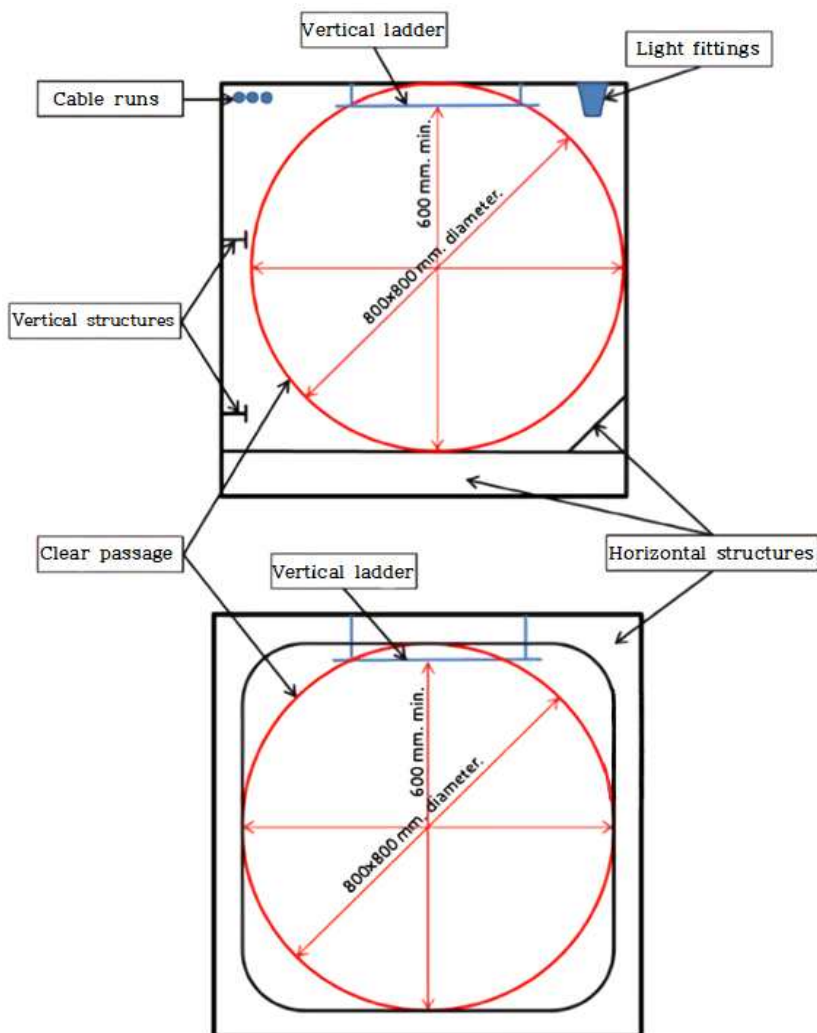

Fig 8.10.4 Internal dimensions of vertical enclosures

7. In applying **203. 1** (4), (6) & **2** (5), (6) of the Rules, the following requirements are to be applied.

(1) Main workshop

A "main workshop" means a compartment enclosed on at least three sides by bulkheads or gratings, usually containing welding equipment, metal working machinery and workbenches.

(2) Machinery control rooms

A "machinery control room" means a space which serves for control and/or monitoring of machinery used for ship's main propulsion.

(3) Continuous fire shelter

A "continuous fire shelter" means a route from a main workshop, or from a machinery control room, which allows safe escape, without entering the machinery space, to a location outside the machinery space. Such a continuous fire shelter need not be a protected enclosure as envisaged by **203. 1** (1) & **2** (1) of the Rules. The boundaries of the continuous fire shelter shall be at least "A-0" class divisions and be protected by self-closing "A-0" class doors. The continuous fire shelter shall have minimum internal dimensions of at least 800 mm x 800 mm for vertical trunks and 600 mm in width for horizontal trunks, and shall have emergency lighting provisions. **Fig 8.10.5** of the Guidance represent typical arrangements of the continuous fire shelters through trunks or through spaces/rooms to a location outside the machinery space, which should be considered as effective.

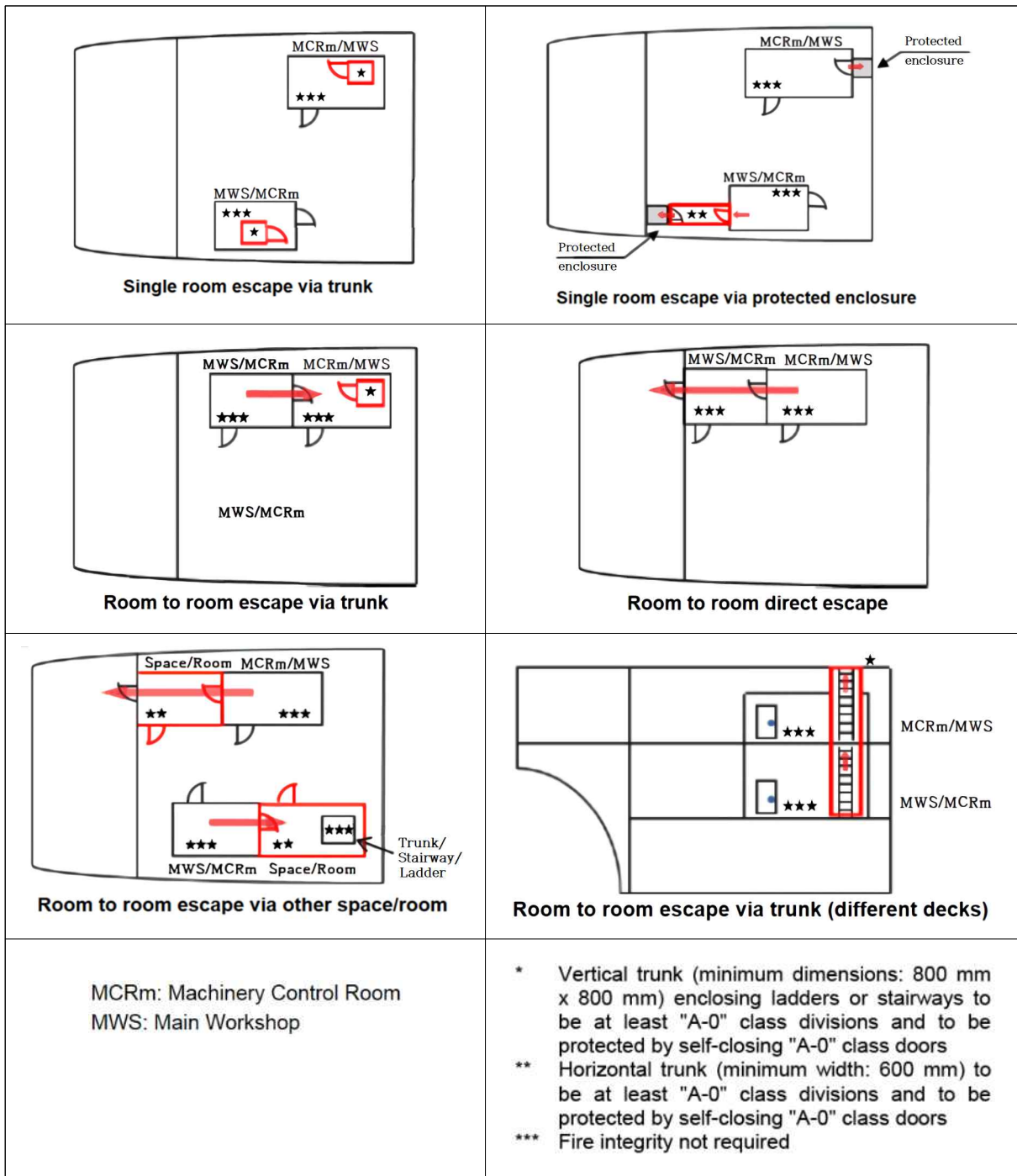

Fig 8.10.5 Typical arrangements of the continuous fire shelters

8. In applying 203. 2 (1), (3), (5) and (6) of the Rules, the following requirements are to be applied.
- (1) A "safe position" can be any space, excluding cargo spaces, lockers and storerooms irrespective of their area, cargo pump-rooms and spaces where flammable liquids are stowed, but including vehicle and ro-ro spaces, from which access is provided and maintained clear of obstacles to the open deck.
  - (2) Machinery spaces of category A may include working platforms and passageways, or intermediate decks at more than one deck level. In such case, the lower part of the space should be regarded as the lowest deck level, platform or passageway within the space. Smaller working platforms in-between deck levels, or only for access to equipment or components, need not be provided with two means of escape.

- (3) A protected enclosure providing escape from machinery spaces of category A to an open deck may be fitted with a hatch as means of egress from the enclosure to the open deck. The hatch should have minimum internal dimensions of 800 mm x 800 mm.
  - (4) In Machinery spaces other than those of category A, which are not entered only occasionally, the travel distance should be measured from any point normally accessible to the crew, taking into account machinery and equipment within the space.
9. In applying **203. 2** (2) & (3) of the Rules, means of escape from the steering gear space in cargo ships shall satisfy the following requirements.
- (1) Steering gear spaces which do not contain the emergency steering position need only have one means of escape.
  - (2) Steering gear spaces containing the emergency steering position can have one means of escape provided it leads directly onto the open deck. Otherwise, two means of escape are to be provided but they do not need to lead directly onto the open deck.

#### 205. Means of escape from ro-ro spaces [See Rule]

1. In applying **205.** of the Rules, the escape (and access) routes are to be so arranged that there are adequate escape routes also during loading and unloading.
2. Means of escape from ro-ro spaces shall satisfy the following requirements.
  - (1) A place where the crew are present to carry out their routine work duties, e.g. during the loading and unloading of a ro-ro deck, or during their ro-ro deck inspections whilst the ship is underway, is considered normally employed.
  - (2) Ro-ro deck inspections could for instance include: fire patrols, inspection of the cargo, check of bilge wells and their alarms, sounding of tanks, cargo deck cleaning, different types of maintenance work (removing of rust, painting, greasing, etc.).
  - (3) Ro-ro spaces should be fitted with at least two means of escape, one located at the fore end and the other at the aft end of the space, from which access is provided to the lifeboat and liferaft embarkation decks. One of the means of escape should be a stairway, the second escape may be a trunk or a stairway.
  - (4) The fore and aft ends of the ro-ro space are considered as the areas being within the distance equal to the breadth of the ro-ro space, measured at its widest point, from its forward most and aftmost point. (see **Fig 8.10.6** of the Guidance)
  - (5) Suitable signs and markings should be provided to indicate the route to the means of escape. ⚓

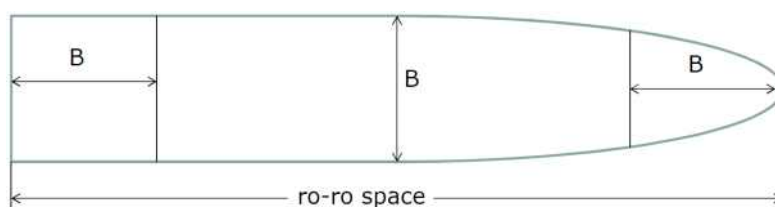

Fig 8.10.6 Fore and aft ends of the ro-ro space



---

## CHAPTER 11 HELICOPTER FACILITIES

### Section 1 Application

#### 101. Application

In applying **101. 4** of the Rules, the relevant regulation of the Convention is to be applied as follows. **【See Rule】**

1. All ro-ro passenger ships shall be provided with a helicopter pick-up area approved by the Society having regard to **Res. A.894(21)** of the recommendation adapted by the IMO.
2. Ro-ro passenger ships of 130 m in length and upwards, constructed on or after 1 July 1999, shall be fitted with a helicopter landing area approved by the Society having regard to **IMO MSC/Circ.895** of the recommendation adapted by the IMO.

### Section 4 Fire-fighting Appliances

#### 401. Fire-fighting appliances

Helicopter facility foam fire-fighting appliances regard to **MSC.1/Circ.1431** of the recommendation adapted by the IMO. **【See Rule】** ⚓

## CHAPTER 12 CARRIAGE OF DANGEROUS GOODS

### Section 1 General Requirements

#### 101. General requirements [See Rule]

1. In applying **101. 1** of the Rules, limited quantities and excepted quantities refer to **3.4** and **3.5** of the **IMDG Code**. (2020)
2. In applying **101. 2 (2)** of the Rules, A purpose built container space is a cargo spaces fitted with cell guides for stowage securing of containers;
3. In applying **101. 2 (3)** of the Rules, Ro-ro spaces include special category spaces and vehicle spaces;

### Section 2 Special Requirements

#### 201. Special requirements [See Rule]

##### 1. Water supplies [See Rule]

- (1) In applying **201. 1** of the Rules, for Open-Top Container Ships of dangerous goods the following requirements may comply with in lieu of the water spray system.
  - (A) Open top container holds are to be protected by a fixed water spray system. The system is to be capable of spraying water into the cargo hold from deck level downward. The system is to be designed and arranged to take account of the specific hold and container configuration. If found necessary, the Society may require a full-scale test.
  - (B) The water spray system is to be able to effectively contain a fire in the container bay of origin. The spray system is to be subdivided, with each subdivision to consist of a ring-line at deck in an open cargo hold around a container bay.
  - (C) The water spray system is to be capable of spraying the outer vertical boundaries of each container bay in an open cargo hold and of cooling the adjacent structure. The uniform application density is to be not less than 1.1 L/m<sup>2</sup>. At least one dedicated fire-extinguishing pump for the hold water spray system with a capacity to serve all container bays in any one open top container hold simultaneously is to be provided. The pump(s) is to be installed outside the open top area. The availability of water to the water spray system is to be at least 50 % of the total capacity, with adequate spray patterns in the open top container hold, and with any one dedicated pump inoperable. For the case of a single dedicated water spray pump this may be accomplished by an interconnection to an alternative source of water. The extinguishing system is to be supplemented by hose supply from the weather deck.
  - (D) The amount of water required for fire-fighting purposes in the largest hold is to allow simultaneous use of the water spray system plus four jets of water from hose nozzles.
- (2) In applying **201. 1 (2)** of the Rules, the number and position of hydrants should be such that at least two of the required four jets of water, when supplied by single lengths of hose, may reach any part of the cargo space when empty; and all four jets of water, each supplied by single lengths of hose may reach any part of ro-ro cargo spaces. And the amount of water required for fire fighting purposes in the largest hold is to satisfy simultaneous use from the water spray systems plus 4 jets of water from hose nozzles.
- (3) In application to **201. 1 (3)** of the Rules, the term "the adverse effect upon stability of the added weight and free surface of water shall be taken into account to the extent deemed necessary by the Society in its approval of the stability information" means that the ships are to be complied with requirements of stability criteria specified in **Pt 1, Annex 1-2 2. (3)** of the Guidance, etc.
- (4) In applying **201. 1 (4)** of the Rules, a high expansion foam system is acceptable except if cargo dangerously react with water.
- (5) In applying **201. 1 (5)** of the Rules, in cases where the mobile water monitors and the "water spray system" (fixed arrangement of spraying nozzles or flooding the cargo space with water) re-

quired by **201. 1 (3)** of the Rules are supplied by the main fire pumps, the total capacity of the main fire pumps and the pipework diameter need only be sufficient to supply whichever of the following is the greater:

- (A) the mobile water monitors and the four nozzles required by **201. 1 (2)** of the Rules; or
- (B) the four nozzles required by **201. 1 (2)** of the Rules and the water spray system required by (3).

The total capacity, however, should not be less than the capacity required in **603. 2**, whichever is smaller.

## 2. Source of ignition (2022) [See Rule]

The electrical equipment are to be complied with the following requirements.

- (1) The electrical equipment provided in the enclosed cargo spaces or vehicle spaces which are regarded as hazardous environment are to be of those approved by the Society taking into account the requirements of IMDG Code. However, even electrical equipment not approved by the Society may be provided in the above-mentioned spaces if they are of IP55 or equivalent, provided that they are not used while dangerous goods are loaded in such spaces.
- (2) In case where electric cables, which are used while dangerous substances are loaded likely to evolve explosive mixture gases, are arranged in cargo spaces, the following requirements are to apply:
  - (A) Cables are to be mineral-insulated copper sheathed cables, lead sheathed and armoured cables or non-metal sheathed and armoured cables.
  - (B) Through runs of cables and those led to electrical equipment installed in cargo spaces are to be protected by metal coverings or the like.
- (3) For electrical equipment other than specified in (A) and (B) above, refer to **IEC 60092-506:2003**.
- (4) the following requirements are to be regarded as sources of ignition, and they are not to be installed in the proximity of the openings of ventilation for cargo spaces:
  - (A) Electrical equipment other than those of safe type approved for use in hazardous environment
  - (B) Windlasses and openings for chain lockers
- (5) Reference is to be made to **IEC 60092-506:2003**.
- (6) For pipes having open ends(e.g., ventilation and bilge pipes, etc.) in hazardous area, the pipe itself is to be classified as hazardous area. See **IEC 60092-506:2003 table B1, item B**.
- (7) When carrying flammable liquids having flashpoints less than 23 °C as Class3, 6.1 or 8 in cargo spaces, the bilge pipes with flanges, valves, pumps, etc. constitute a source of release and the enclosing spaces (e. g. pipe tunnels, bilge pump rooms, etc.) are to be classified as an extended hazardous area (comparable with Zone 2) unless these spaces are continuously mechanically ventilated with a capacity for at least six air changes per hour. Except where the space is protected with redundant mechanical ventilation capable of starting automatically, equipment not certified for Zone 2 are to be automatically disconnected following loss of ventilation while essential systems such as bilge and ballast systems are to be certified for Zone 2.  
Where redundant mechanical ventilation is employed, equipment and essential systems not certified for zone 2 shall be interlocked so as to prevent inadvertent operation if the ventilation is not operational. Audible and visible alarm shall be provided at a manned station if failure occurs.  
(2019)

## 4. Ventilation arrangement [See Rule]

- (1) In applying **201. 4** of the Rules, If the enclosed cargo space has access from another enclosed space, the door shall be self-closing.
- (2) In applying **201. 4** of the Rules, the following requirements are to be complied with.
  - (A) If adjacent spaces are not separated from cargo spaces by gastight bulkheads or decks, then they are considered as part of the enclosed cargo space and the ventilation requirements are to apply to the adjacent space as for the enclosed cargo space itself.
  - (B) Where the IMSBC Code requires 2 fans per hold, a common ventilation system with 2 fans connected is acceptable.
  - (C) Where the IMSBC Code requires continuous ventilation, this does not prohibit ventilators from being fitted with a means of closure as required for fire protection purposes under **Ch 2, 201. 1 (1)** of the Rules provided the minimum height to the ventilator opening is to be in accordance with ICLL(4.5 m for Position 1 and 2.3 m for Position 2).
  - (D) For open top container ships, power ventilation is to required only for the lower part of the

cargo hold for which purpose ducting is required. The ventilation capacity is to be at least 2 air changes per hour, based on the empty hold volume below weather deck.

- (3) In applying **201. 4 (2)** of the Rules, in case where electric motor driven ventilating fans are installed, the following requirements are to be complied with:
- (A) Where a ventilating fan of internal motor-driven type is installed, the motor is to be of the one approved by the Society for use in hazardous environment taking into account the requirements of the IMDG Code (see **Fig. 8.12.1 (a)** of the Guidance).
  - (B) Where a ventilating fan of external motor-driven type is installed on exposed deck, the motor is to be of the covering equivalent to IP55 or upward (see **Fig. 8.12.1 (b)** of the Guidance).
  - (C) Even in the case of (2) above, where the motor is installed in the proximity of the exhaust opening, the motor is to comply with the requirements of (1) above (see **Fig. 8.12.1 (c)** of the Guidance).
  - (D) Ventilation fan of non-sparking type is to be provided and complied with the requirements specified in **Ch 3, 104.** of the Rules.

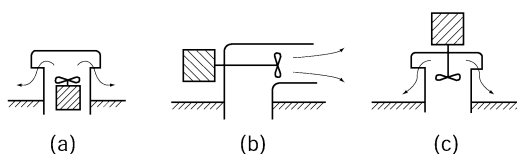

**Fig 8.12.1 Ventilating fans of motor-driven type**

- (4) The reduced air changes per hour as per Note 1 of Table 8.12.1 of the Rules apply equally to the ventilation air change requirements in **201. 4 (1)** and in **201. 5 (4)** of the Rules, when the bilge pump is located directly inside a container cargo space.

In such a case, where several container cargo spaces are served by the same bilge pump, the bilge pump is to be installed in the container cargo space with the highest ventilation rate, compared to the other container cargo spaces. (2020)

#### 5. Bilge pumping [See Rule]

- (1) In applying **201. 5** of the Rules, bilge systems for open top container holds should be independent of the machinery space bilge system and be located outside of the machinery space.
- (2) In applying **201. 5 (2)** of the Rules, if a single drainage system completely independent of the machinery space is provided, the system is to comply with the Rules requirement to redundancy and capacity based on the size of the space or space which it services.
- (3) In applying **201. 5 (3)** of the Rules, in case where bilge pipes are led to machinery spaces, the following requirements are to be complied with :
  - (A) Caution plate stating that the bilge pipes are to be blocked while dangerous goods are loaded on board are to be posted in the vicinity of the above-mentioned closed lockable valve or blank flanges.
  - (B) Eductors are to be provided as the means of bilge discharging for cargo spaces so that bilges can be discharged overboard without passing through machinery spaces.

#### 6. Personnel protection [See Rule]

- (1) In applying **201. 6 (1)** of the Rules, for solid bulk cargoes the protective clothing is to satisfy the equipment requirements specified in Appendix 1 of the IMSBC Code for the individual substances. For packaged goods the protective clothing is to satisfy the equipment requirements specified in emergency procedures (EmS) of the Supplement to IMDG Code for the individual substances.
- (2) In applying **201. 6 (2)** of the Rules, These spare bottles are to be in addition to the spare bottles required for fireman's outfit.

#### 7. Portable fire extinguishers [See Rule]

Two portable fire extinguishers, each having a capacity of not less than 6 kg of dry powder or equivalent, should be provided when dangerous goods are carried on the weather deck, in open ro-ro spaces and vehicle spaces, and in cargo spaces as appropriate. The type has to correspond to the Class B ones specified in **Table 8.8.3-1** of this Guidance.

**8. Insulation of machinery space boundaries [See Rule]**

In applying **201. 8** of the Rules, In the case that a closed or semi-closed cargo space is located partly above a machinery space and the deck above the machinery space is not insulated, dangerous goods are prohibited in the whole of that cargo space. If the uninsulated deck above the machinery space is a weather deck, dangerous goods are prohibited only for the portion of the deck located above the machinery space.

In a case where dangerous goods are carried, no direct access is, in principle, to be provided between machinery spaces and cargo spaces. However, the access may be acceptable provided that air lock space with double self-closing steel doors of reasonably gastight is provided between those spaces. However, when dangerous goods without involving the hazard of generating noxious gas (including the case of fire) are carried, this requirement may be dispensed with.

In a case where explosives are stowed at least 3 m horizontally away from the machinery space boundaries, refer to **Fig 8.12.2** of the Guidance.

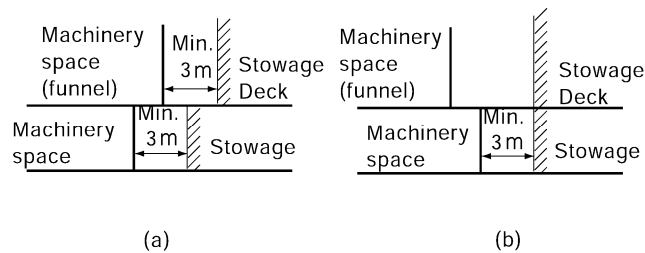

**Fig 8.12.2 Areas acceptable to stowage of explosives**

9. In applying **201. Table 8.12.1** of the Rules, a ro-ro space fully open above and with full openings in both ends may be treated as a weather deck. **[See Rule]**

---

### Section 3 Document of compliance

#### 301. Document of compliance [See Rule]

1. Refer to Document of compliance with the special requirements for ships carrying dangerous goods under the provisions of regulation II-2/19, as amended, and paragraph 7.17 of the 2000 HSC Code, as amended (MSC.1/Circ.1266)
2. Certification for carriage of solid dangerous bulk cargoes covers only those cargoes listed in Group B in the IMSBC Code except cargoes classified solely as MHB. Other solid dangerous bulk cargoes may only be permitted subject to acceptance by the Administrations involved.
3. Refer to the MSC/Circ.1148, issuing and renewal of document of compliance with the special requirements applicable to ships carrying dangerous goods ↴

## CHAPTER 13 PROTECTION OF VEHICLE, SPECIAL CATEGORY AND RO-RO SPACES

### Section 1 General Requirements

#### 102. Basic principles for passenger ships

In applying **102. 1** of the Rules, the "Total overall clear height for vehicles" is the sum of distances between deck and web frames of the decks forming one horizontal zone. **【See Rule】**

### Section 2 Precaution against ignition of flammable vapours in closed vehicle spaces closed ro-ro spaces and special category spaces

#### 201. Ventilation systems

1. In applying **201. 2 (4)** of the Rules, "the guidelines developed by IMO" means **MSC.1/Circ.1515 Appendix 1.(2018)** **【See Rule】**
2. In applying **201. 3** of the Rules, the requirements to indicate any loss of ventilation capacity is considered complied with by an alarm on the bridge, initiated by fall-out of starter relay of fan motor. **【See Rule】**
3. In applying **201. 4 (1)** of the Rules, rapid shutdown of ventilation system is to be provided with dampers which can be isolated by a single action or closing appliances capable of isolation at equivalent closing speed. And ro-ro spaces capable of being sealed are to be capable of being sealed from a location outside of such cargo spaces, if they are protected with a fixed gas fire-extinguishing system. Access routes to the controls for closure of the ventilation system "permit a rapid shutdown" and adequately "take into account the weather and sea conditions" if the routes: **【See Rule】**
  - (1) are at least 600 mm clear width;
  - (2) are provided with a single handrail or wire rope lifeline not less than 10 mm in diameter, supported by stanchions not more than 10 m apart in way of any route which involves traversing a deck exposed to weather; and
  - (3) are fitted with appropriate means of access (such as ladders or steps) to the closing devices of ventilators located in high positions.
  - (4) Alternatively, remote closing and position indicator arrangements from the bridge or a fire control station for those ventilator closures is acceptable.
4. In applying **201. 5** of the Rules, "permanent openings" are to be arranged at the outside of the areas within the survival craft length plus 2 m from its ends in vertical direction on the shell plating under conditions of trim of up to 10 degrees and heel of list of up to 20 degrees. (Refer to **Fig 8.13.1** of the Guidance). **【See Rule】**

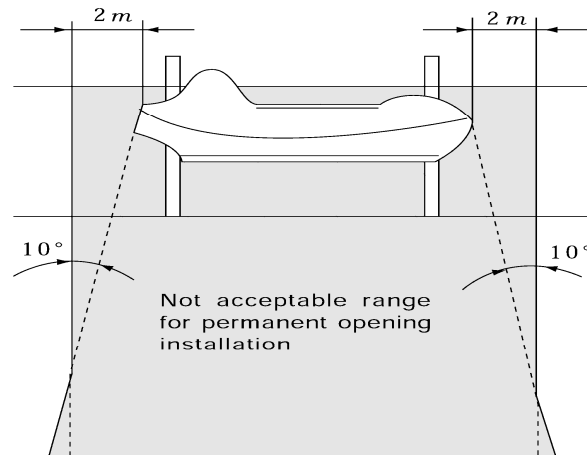

Fig 8.13.1 Not acceptable range for permanent opening installation

## 202. Electrical equipment and wiring (2022) [See Rule]

1. In applying **202. 1** and **203.** of the Rules, the electrical equipment “shall be of a type suitable for use in explosive petrol and air mixtures”, “shall be of a type approved for use in explosive petrol and air mixtures” means to be realized by requiring certified safe equipment suitable for use in **Zone 1** areas as defined in **IEC 60079-10-1:2015** (Gas Group IIA and Temperature Class T3) (Refer to **IEC 60079-14:2013** for types of protection suitable for use in **Zone 1** areas), and ventilation fan of non-sparking type is to be provided and complied with the requirements specified in **Ch 3, 104.** of the Rules. The windlass and opening for chain lockers are to be regarded as sources of ignition.
2. In applying **202. 2** of the Rules, “electrical equipment of a type so enclosed and protected as to prevent the escape of sparks” means to be realized by requiring an enclosure of at least IP55, or apparatus suitable for use in **Zone 2** areas as defined in **IEC 60079-10-1:2015**. Refer to **IEC 60079-14:2013** for types of protection suitable for use in **Zone 2** areas.

## 203. Electrical equipment and wiring in exhaust ventilation ducts [See Rule]

In applying **203.** of the Rules, air ventilation of ro-ro spaces is to be of the exhaust type. However, in the following cases, the ventilation may be of the suction type:

1. In case where there are no openings except to exposed spaces.
2. In case where machinery spaces of category A or accommodation spaces contiguous thereto are provided, and an air-locked corridor is available when access opening for the spaces is provided (see **Fig 8.13.2** of the Guidance).
3. In case where spaces other than those shown in (2) above are adjoining with the spaces and access opening thereto is provided, self-closing door of reasonable gas-tightness is to be provided. However, where the hatch is inevitably installed, this hatch is to be gas-tightness and is to be accompanied by a warning such as “the hatch is to be closed at all times”. (2017)



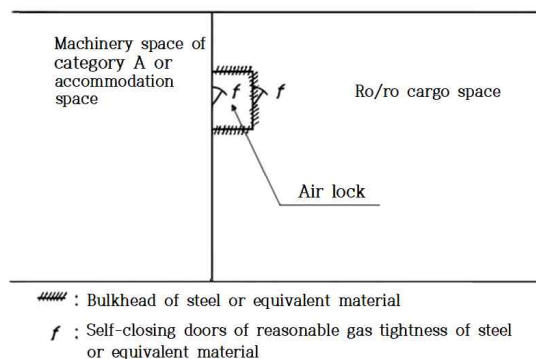

Fig 8.13.2 Air lock (2017)

### Section 3 Detection and alarm

#### 301. Fixed fire detection and fire alarm systems [See Rule]

This requirement need not apply to weather decks used for carriage of vehicles with fuel in their tanks.

### Section 5 Fire-extinction

#### 501. Fixed fire-extinguishing systems

1. In applying **501. 1** (3) and **2** of the Rules, a fixed water-based fire fighting system complying with the provisions of the Fire Safety System Code is to be of a type approved and requirements of design and installation complying with MSC.1/Circ.1430 of the recommendation adapted by the IMO. The fire and component tests previously conducted in accordance with MSC.1/Circ.1272 are to be remained valid for the approval of new systems. **[See Rule]**
2. In applying **501. 4** (1) of the Rules, (A), (B), (C) are to be applied above the bulkhead deck and (D) is to be applied below the bulkhead deck. **[See Rule]**
3. In applying **301.** and **501.** of the Rules, the regulations for a fixed fire extinguishing system, fire detection, foam applicators and portable extinguishers need not apply to weather decks used for the carriage of vehicle with fuel in their tanks.

#### 502. Portable fire extinguishers

In applying **502. 2** of the Rules, cargo holds loaded with vehicles with fuel in their tanks which are stowed in open or closed containers need not to be provided with portable fire extinguishers, water-fog applicators and foam applicator units. **[See Rule]** ⚓

## Annex 8-1 Fire Protection Materials

### 1. Fire protection materials for Method IC (2020)

Requirements for components  Ch 3/Ch 4 of the Rules		Noncombustible material	Noncombustible material	Low flame spread	Equivalent volume	Calorific value	Smoke production	Not readily ignite
		Ch 3 201. 2.	Ch 3 201. 1.	Ch 3 202. 4.	Ch 3 202. 3. (1)	Ch 3 202. 2.	Ch 4	Ch 2 304.
Kinds of Components								
1	Moulding				○			
2	Panel	○						
3	Painted surface, veneer, fabric or foils			○	○	○	○ <sup>(2)</sup>	
4	Painted surface, veneer, fabric or foils			○	○	○	○ <sup>(2)</sup>	
5	Decoration				○		○	
6	Painted surface, veneer, fabric or foils				○	○	○ <sup>(2)</sup>	
7	Skirting board				○			
8	Insulation		○ <sup>(1)</sup>					
9	Surfaces and paints in concealed or inaccessible spaces			○				
10	Draught stop	○						
11	Grounds and supports	○		○				
12	Lining	○						
13	Primary deck covering 1st layer						○ <sup>(4)</sup>	○
14	Floor finishing			○ <sup>(3)</sup>			○	
15	Window box	○						
16	Window box surface			○	○	○	○	
17	Window box surface in concealed or inaccessible spaces			○				
18	Ceiling panel	○						

NOTES:

1. Wherever “○” appears it means that the requirements are applicable.
2. The superscripts to “○” are as follows:
  - (1) Vapour barriers and adhesives used in conjunction with insulations, as well as the insulation of pipe fittings, for cold service systems, need not be of non-combustible materials, but their exposed surfaces are to have low flame-spread characteristics.
  - (2) Applicable to paints, varnishes and other finishes.
  - (3) Only in corridors and stairway enclosures.
  - (4) Only in accommodation and service spaces and control stations
    - Paints, varnishes and other finishes only applies to accommodation spaces, service spaces and control stations as well as stairway enclosures.
    - As far as window boxes construction is concerned, reference is also to be made MSC/Circ.917 and MSC/Circ.917 Add.1.
3. The number of components is referred to the following drawing. (see Fig Annex 8-1)

2. Fire protection materials for Method IIC and IIIC (2020)

Requirements for components  Ch 3/Ch 4 of the Rules		Noncombustible material	Noncombustible material	Low flame spread	Equivalent volume	Calorific value	Smoke production	Not readily ignite
		Ch 3 201. 2.	Ch 3 201. 1.	Ch 3 202. 4.	Ch 3 202. 3. (1)	Ch 3 202. 2.	Ch 4	Ch 2 304.
Kinds of Components								
1	Moulding				○ <sup>(3)</sup>			
2	Panel	○ <sup>(4)</sup>						
3	Painted surface, veneer, fabric or foils			○	○	○	○ <sup>(5)</sup>	
4	Painted surface, veneer, fabric or foils			○	○ <sup>(3)</sup>	○ <sup>(2)</sup>	○ <sup>(5)</sup>	
5	Decoration				○ <sup>(3)</sup>		○	
6	Painted surface, veneer, fabric or foils				○ <sup>(3)</sup>	○ <sup>(2)</sup>	○ <sup>(5)</sup>	
7	Skirting board				○ <sup>(3)</sup>			
8	Insulation		○ <sup>(1)</sup>					
9	Surfaces and paints in concealed or inaccessible spaces			○				
10	Draught stop	○ <sup>(4)</sup>						
11	Grounds and supports	○ <sup>(4)</sup>		○				
12	Lining	○ <sup>(4)</sup>						
13	Primary deck covering 1st layer						○ <sup>(7)</sup>	○
14	Floor finishing			○ <sup>(6)</sup>			○	
15	Window box	○ <sup>(4)</sup>						
16	Window box surface			○ <sup>(3)</sup>	○ <sup>(3)</sup>	○ <sup>(2)</sup>	○	
17	Window box surface in concealed or inaccessible spaces			○				
18	Ceiling panel	○ <sup>(4)</sup>						

NOTES:

1. Wherever “○” appears it means that the requirements are applicable.
2. The superscripts to “○” are as follows:
  - (1) Vapour barriers and adhesives used in conjunction with insulations, as well as the insulation of pipe fittings, for cold service systems, need not be of non-combustible materials, but their exposed surfaces are to have low flame-spread characteristics.
  - (2) Where the material is fitted on non-combustible bulkheads, ceiling and lining in accommodation and service spaces.
  - (3) To be applied to those accommodation and service spaces bounded by non-combustible bulkheads, ceiling and linings.
  - (4) Only in corridors and stairway enclosures serving accommodation and service spaces and control stations.
  - (5) Applicable to paints, varnishes and other finishes.
  - (6) Only in corridors and stairway enclosures.
  - (7) Only in accommodation and service spaces and control stations
    - Paints, varnishes and other finishes only applies to accommodation spaces, service spaces and control stations as well as stairway enclosures.
    - As far as window boxes construction is concerned, reference is also to be made MSC/Circ.917 and

MSC/Circ.917 Add.1.

3. The number of components is referred to the following drawing. (see Fig Annex 8-1)

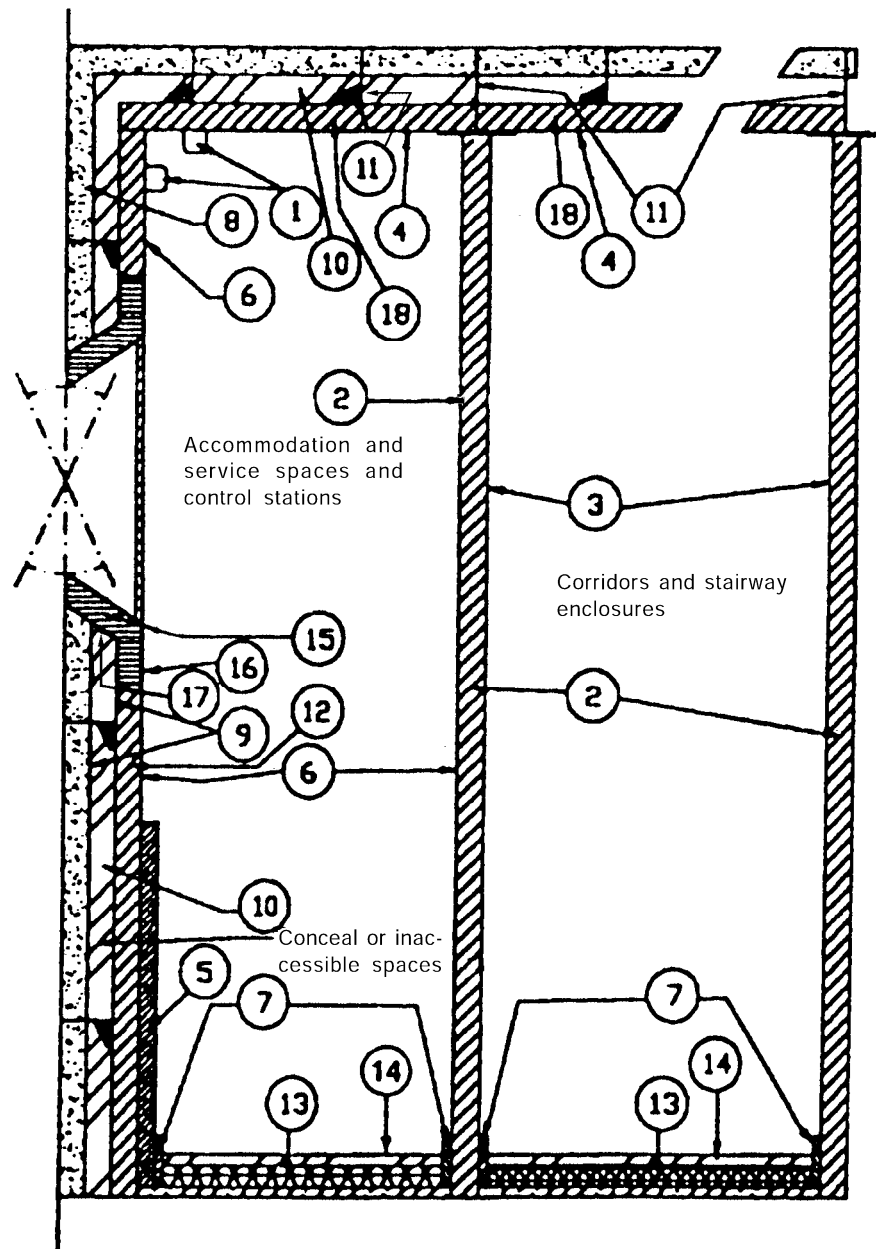

Fig. Annex 8-1

3. Materials used for bulkheads of accommodation spaces (2018)

Requirements for components Ch 3/Ch 4 of the Rules		Non-combustible material	Calorific value	Equivalent volume	Low flame spread	Smoke production, toxic products
		Ch 3 201. 1. & 2. (1)	Ch 3 202. 2.	Ch 3 202. 3.	Ch 3 202. 4 *	Ch 4 Sec 1
Kinds of Components						
1	Moulding			○		
2	Wall panel (lining)	○				
3	Grounds and supports	○				
4	Draft stops	○		○		
5	Insulation	○				
6	Insulation surface **				○ Ch 3 202. 4 (1) (B)	
7	Decoration			○		
8	Painted surface ** or Fabric or veneer **		-		○ Ch 3 202. 4 (1) (B)	
			○		○ Ch 3 202. 4 (1) (B)	
9	Painted surface or Fabric or veneer		-	○	○ Ch 3 202. 4 (1) (A)	○
			○	○	○ Ch 3 202. 4 (1) (A)	○
10	Skirting board			○		

Notes

Wherever “○” appears it means that the requirements are applicable.

\* : Exposed surfaces of corridors and stairway enclosures referred to in **Ch 3 202. 4. (1) (A)** of the Rules includes floor coverings.

\*\* : Where the wall panel is an integral part of the fire insulation in accordance with **Ch 7 102. 3. (3)** of the Rules, these components are to be of non-combustible material.

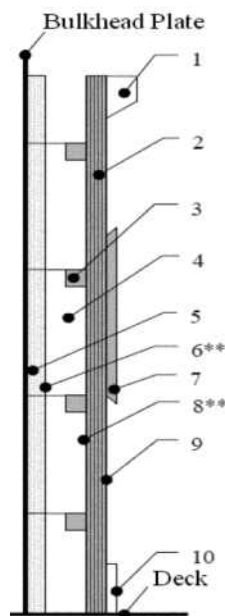

## Annex 8-2 Penetrations through Divisions

### 1. Penetrations of Pipes or Trunks

#### 1.1 Penetrations through "A" and "B" class divisions (steel or equivalent material) (2020)

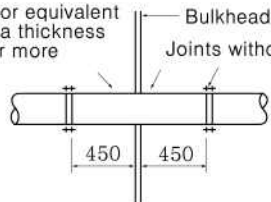
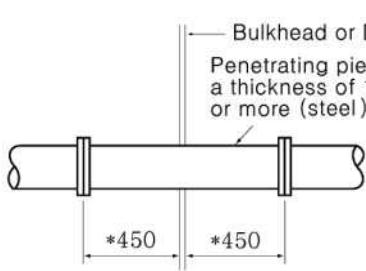
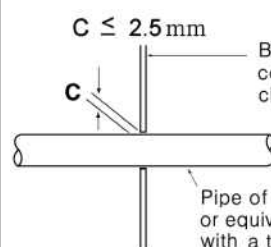
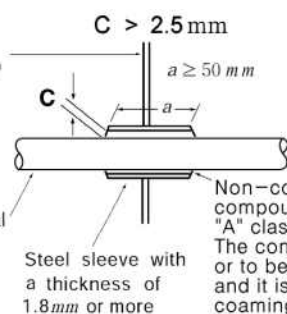
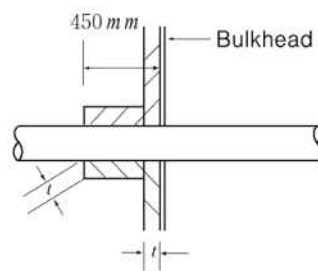
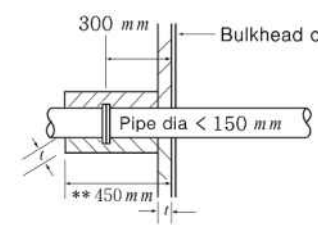
Division	Details of penetrations	
"A" class division	<p>Pipe of steel or equivalent material with a thickness of 3.0 mm or more</p> <p>Bulkhead or Deck</p> <p>Joints without gaps</p> 	
"B" class division	<p>Bulkhead or Deck</p> <p>Penetrating piece with a thickness of 1.8 mm or more (steel)</p>  <div style="display: flex; justify-content: space-around;"> <div style="text-align: center;"> <p><math>C \leq 2.5 \text{ mm}</math></p>  <p>Bulkhead or continuous "B" class ceiling</p> <p>Pipe of steel or equivalent material with a thickness of 1.8 mm or more</p> </div> <div style="text-align: center;"> <p><math>C &gt; 2.5 \text{ mm}</math></p>  <p><math>a \geq 50 \text{ mm}</math></p> <p>Steel sleeve with a thickness of 1.8 mm or more</p> <p>Non-combustible compound or compound used in the approved "A" class cable penetrations. The compound is not to peel off or to be detached due to vibration, and it is to be fully filled in the coaming interior.</p> </div> </div>	
	"B" class division bulkhead or deck: "B" class panel or steel	
Prevention of heat transmission (2019)	 <p>450 mm</p> <p>Bulkhead or Deck</p>	<p>Applicable only to the penetration of "B" class divisions with a pipe diameter of less than 150 mm</p>  <p>300 mm</p> <p>Bulkhead or Deck</p> <p>Pipe dia &lt; 150 mm</p> <p>** 450 mm</p>
	<p>** In case the penetrations passes the FTP code test (In case of having the equal fire integrity with 450 mm) or In case penetration piece and duct connection part have a structure that heat can not be transferred, 300 mm is admitted.</p>	

1.2 Pipes and trunks made of materials readily rendered ineffective by heat (PVC, FRP, aluminium alloy, lead, etc)

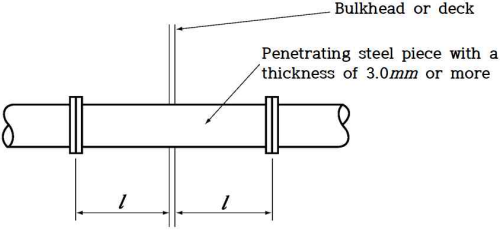
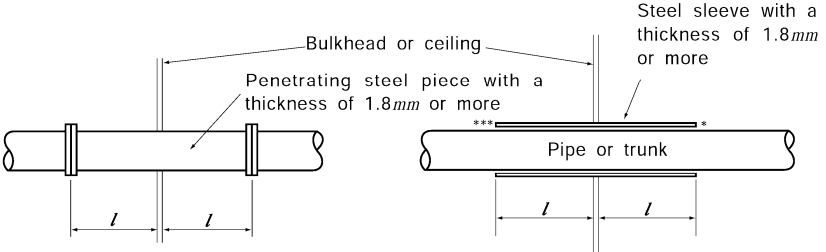
Division	Details of penetrations
"A" class division	 <p>The thickness of penetrating pieces may be that of the carbon steel pipes for ordinary piping of national standard according to their nominal diameter.</p>
"B" class division	 <p>Pipes or trunks with nominal diameter of 30 mm or less need not comply with this requirement.</p>
<p>NOTES:</p> <ol style="list-style-type: none"> <li>1. <math>l</math> is the distance from the divisions to the end of sleeve or joint which is to be 450 mm or more, but in case of where in "B" class division, <math>l</math> is to be not less than 300 mm for pipe diameters of less than 150 mm. However, the shorter length may be permitted when the equivalent fire integrity is obtained by a standard fire test for division with a shorter steel sleeve or penetrating piece.</li> <li>2. The steel penetrating piece or steel sleeve provided on the pipe or trunk on the side of the open end in case where the open end is located within <math>l</math> from the divisions, may be up to the open end.</li> <li>3. Thermal insulation is to be applied to 150 mm or more of the length on one side of the penetrating pieces or steel sleeves according to the fire integrity of the divisions. The steel penetrating piece or steel sleeve provided on the pipe or trunk on the side of the open end in case where the open end is located within 50 mm from the divisions, may be up to the open end.</li> <li>4. The pipe is to be connected to the ends of the sleeve by flanges or couplings; or the clearance (with mark ***) between the sleeve and the pipe is not to exceed 2.5 mm; or any clearance between pipe and sleeve is to be made tight by means of non-combustible or other suitable material.</li> <li>5. Uninsulated metallic pipes penetrating "A-0" or "B-0" class divisions are to be of a suitable material, the melting temperature of which exceeds 950 °C for "A-0" and 850 °C for "B-0" class divisions.</li> <li>6. For penetrations in "A" or "B" class divisions, a fire-tested penetration device other than that mentioned above, suitable for the fire resistance of the division pierced and the type of pipe used, may be accepted (reference is made to IMO Res. A.753 (18) and the Fire Test Procedures Code.).</li> </ol>	

2. Penetrations of Ventilation Ducts (2017)

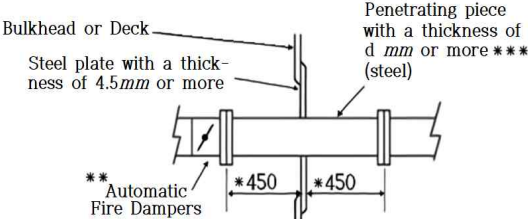
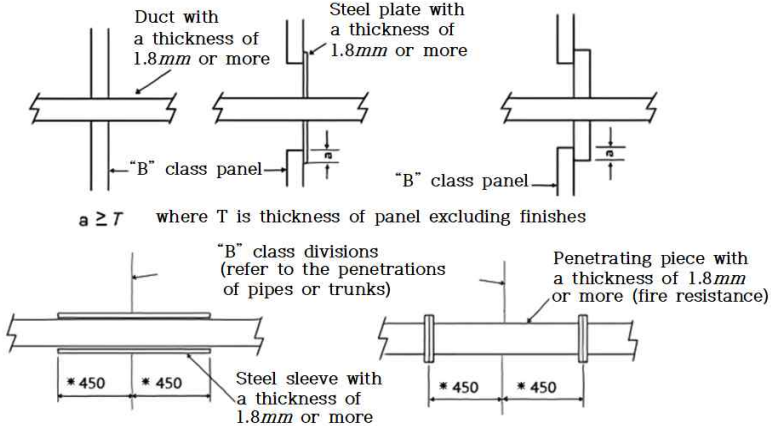
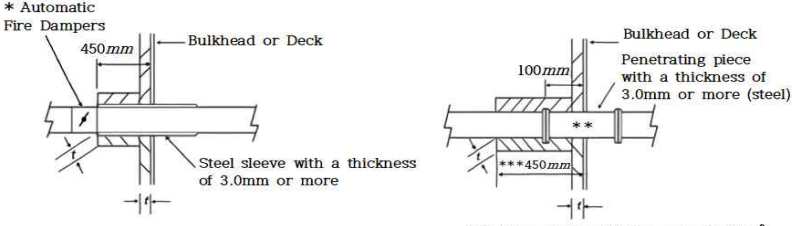
Division	Penetrations of ventilation ducts
<p>"A" class</p>	 <p>Bulkhead or Deck Steel plate with a thickness of 4.5mm or more Penetrating piece with a thickness of d mm or more *** (steel) ** Automatic Fire Dampers *450 *450</p> <p>* When free cross-sectional Duct area(A) <math>\leq 0.02 \text{ m}^2</math>, it may be reduced to 100 mm (Only, in the case of the deck, wholly laid on the lowed side of the decks pierced) ** When <math>A &gt; 0.075 \text{ m}^2</math> *** <math>A &lt; 0.075 \text{ m}^2</math> : d = 3.0 mm <math>0.075 \leq A \leq 0.45 \text{ m}^2</math> : d = 4 mm <math>A &gt; 0.45 \text{ m}^2</math> : d = 5 mm</p>
<p>"B" class</p>	 <p>Duct with a thickness of 1.8mm or more Steel plate with a thickness of 1.8mm or more "B" class panel a <math>\geq T</math> where T is thickness of panel excluding finishes "B" class divisions (refer to the penetrations of pipes or trunks) Penetrating piece with a thickness of 1.8mm or more (fire resistance) Steel sleeve with a thickness of 1.8mm or more *450 *450 *450 *450</p> <p>* When free cross-sectional Duct area <math>\leq 0.02 \text{ m}^2</math>, it may be reduced to 100mm</p>
<p>Prevention of heat treatment</p>	 <p>* Automatic Fire Dampers 450mm Bulkhead or Deck Steel sleeve with a thickness of 3.0mm or more * (if needed)</p> <p>Bulkhead or Deck 100mm Penetrating piece with a thickness of 3.0mm or more (steel) ***450mm</p> <p>** Free cross-sectional area <math>\leq 0.02 \text{ m}^2</math> *** In case the penetrations passes the FTP code test (in case of having the equal fire integrity with 450mm) or in case penetration piece and duct connection part have a structure that heat can not be transferred, 100mm is admitted.</p>
<p>Note) Combustible gaskets in flanged ventilation duct connections are not permitted within 600 mm of openings in "A" or "B" class divisions.</p>	

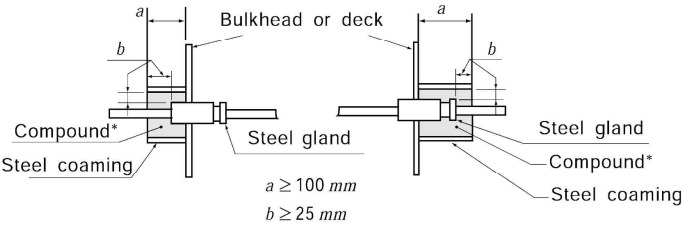
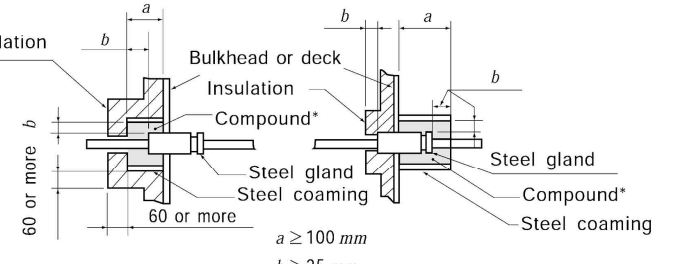
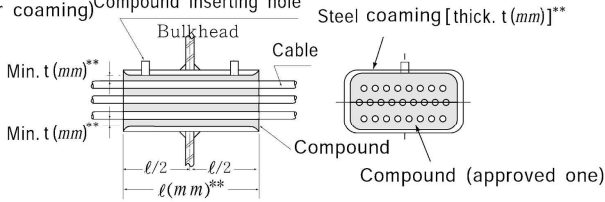
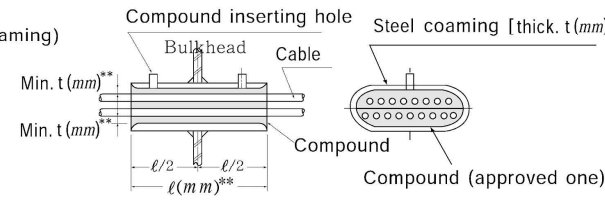
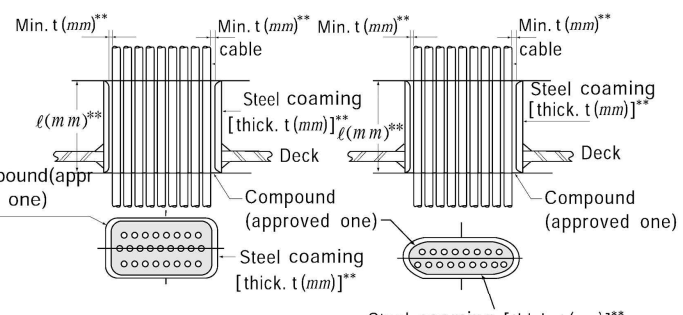

3. Penetrations of Electric Cables

Division	Details of electrical cable penetrations	
Single cable penetration	"A-0" class division	 <p style="text-align: center;"><math>a \geq 100 \text{ mm}</math> <math>b \geq 25 \text{ mm}</math></p>
	Division other than "A-0" class	 <p style="text-align: center;"><math>a \geq 100 \text{ mm}</math> <math>b \geq 25 \text{ mm}</math></p>
Multi-cable penetration	"A-0" class bulkhead	<p>(Rectangular coaming) Compound inserting hole Steel coaming [thick. <math>t(mm)</math>]**</p>  <p>(Circular coaming) Compound inserting hole Steel coaming [thick. <math>t(mm)</math>]**</p> 
	"A-0" class deck	<p>(Rectangular coaming) (Circular coaming)</p> 
<p>NOTES:</p> <ol style="list-style-type: none"> <li>* Compound means non-combustible compound or compound used in the approved "A" class penetration for cables.</li> <li>Cable penetrations in "A" class divisions are to be tested and approved in accordance with Ch 3. of "Guidance for Approval of Manufacturing Process and Type Approval. Etc."</li> <li>** The thickness(<math>t</math>) &amp; length(<math>l</math>) should be used with the same dimensions passed in the type approval test in accordance with FTP code.</li> </ol>		

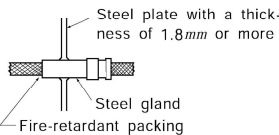
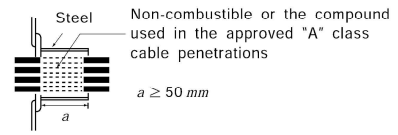
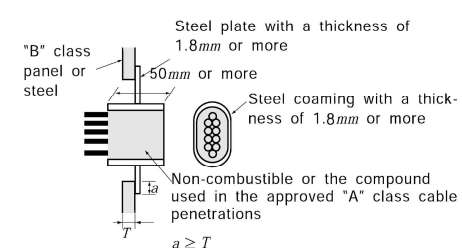
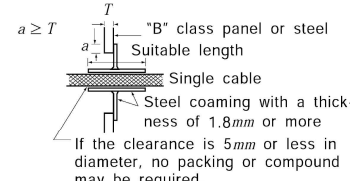
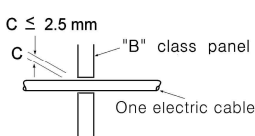
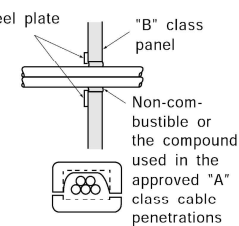
Division	Details of cable penetrations
<p>"B" class</p>	 <p>Steel plate with a thickness of 1.8mm or more</p> <p>Steel gland</p> <p>Fire-retardant packing</p>
	 <p>Steel</p> <p>Non-combustible or the compound used in the approved "A" class cable penetrations</p> <p><math>a \geq 50 \text{ mm}</math></p>
	 <p>Steel plate with a thickness of 1.8mm or more</p> <p>"B" class panel or steel</p> <p>50mm or more</p> <p>Steel coaming with a thickness of 1.8mm or more</p> <p>Non-combustible or the compound used in the approved "A" class cable penetrations</p> <p><math>a \geq T</math></p>
	 <p><math>a \geq T</math></p> <p><math>T</math></p> <p>"B" class panel or steel</p> <p>Suitable length</p> <p>Single cable</p> <p>Steel coaming with a thickness of 1.8mm or more</p> <p>If the clearance is 5mm or less in diameter, no packing or compound may be required.</p>
	 <p><math>C \leq 2.5 \text{ mm}</math></p> <p>"B" class panel</p> <p>One electric cable</p>
	 <p>Steel plate</p> <p>"B" class panel</p> <p>Non-combustible or the compound used in the approved "A" class cable penetrations</p>

**Annex 8-3 Special Requirements for Ships which are not engaged in international voyage or Ships of less than 500 gross tonnage  
(Fire-fighting system of ships which are subject to Ships Safety Law of the Korean Government, but not SOLAS, shall follow the relevant requirements)**

1. For ships of less than 500 gross tonnage or not engaged in international voyage and for restricted service, such ships may be also loosened as follows.
  - (1) Machinery spaces are to be complied with the following requirements,
    - (A) Means are to be provided in machinery spaces, capable of effectively ventilating to ensure prevention of accumulation of flammable vapours under normal service condition and releasing smoke in the event of fire.
    - (B) The number of skylights, doors, ventilators, openings in funnels to permit exhaust ventilation and other openings to machinery spaces is to be reduced to a minimum consistent with the needs of ventilation.
    - (C) The openings given in (B) above are to be provided with the closing arrangement which is capable of being operated from a place outside machinery spaces in the event of fire.
    - (D) In addition to the requirements given in (A), (B) and (C) above, the periodically unattended machinery spaces are to be provided with the fire protection arrangement as considered appropriately in consideration of the risk of fire where deemed necessary by the Society.
  - (2) For unmanned barges not propelled by mechanical means, the requirements specified in para 1 (1) above need not to apply. For manned barges provided with machinery spaces, the requirements specified in para 1 (1) above are, in principle, to apply. However, the extent and degree of application of the requirements may be modified to a reasonable extent depending on the construction, purpose, etc. of the barges.
  - (3) Where ship is not engaged in international voyage or Ships of less than 500 gross tonnage, the machinery system may be dispensed with as follows:
    - (A) Where the capacity of fuel oil tank (including fuel valve cooling oil tank, light oil tank, fuel oil additive tank) or lubricating oil tank is not more than 1 m<sup>3</sup>, it is to be omitted for the valves or cocks having remote closing means.
    - (B) In case of passenger ships, it is to be omitted for the requirement of oil level gauges given in **Ch 2, 102. 3 (5) (B) (a)** of the Rules.
    - (C) In application to **Ch 2, 102. 5 (2)** of the Rules, the requirements specified in **Ch 2, 102. 5 (2)** of the Rules may not be applied except for the following.
      - (a) Internal combustion engines having a cylinder bore exceeding 150 mm
      - (b) Internal combustion engines having a cylinder bore not exceeding 150 mm and corresponding to the following.
        - (i) Where provided for UMA ships and used for main engines or driving generators
        - (ii) Where provided for FRP ships with costal service(passenger ship only) and used for main engines having total output of 375 kW or over.
    - (D) It is to be omitted for the requirement of means of isolating fuel supply and spill piping given in **Ch 2, 102. 5 (5)** of the Rules.
    - (E) In application to **Ch 2, 102. 3 (5) (B)** of the Rules, where the glass level gauges comply with the following, tanks having 1 m<sup>3</sup> or less in its full capacity may be provided with round glass level gauges. For small oil tanks other than fuel oil tanks, level gauges made of synthetic resin instead of glass may be used.
      - (a) Those are to be approved by the Society or to comply with "KS V 7222 (Glass Level Gauges with Self-closing Valve for Vessels)".
      - (b) Where connection pipe of glass level gauge is located under overflow pipe, valve or cock is to be provided on upper part of level gauge.
      - (c) Those are to be provided with *K* or *L* type protection according to *KS V 7222*.
    - (F) The oil-level gauge installation requirement specified in **Ch 2, 102. 3 (5) (A) (a)** of the Rules may be omitted for fuel oil tanks located in the double bottom of ships other than passenger ships. (2024)
2. For passenger ships, such ships may be also loosened as follows.
  - (1) Fire pumps, etc may be loosened as follows.
    - (A) Where passenger ships not engaged in international voyage and for restricted service are

- provided with two fire pumps, the total capacity of fire pumps is not less than two thirds of the quantity required to be dealt with by each of the independent bilge pumps and capable of delivering for fire-fighting purposes such quantity. But, the total capacity of fire pumps need not to exceed 180 m<sup>3</sup>/h.
- (B) Where passenger ships of less than 1,000 gross tonnage, not engaged in international voyage and for restricted service, one independent fire pump driven by power may be provided. In this cases, passenger ships of less than 100 gross tonnage may be provided with a portable power-driven pump instead of such fire pump.
  - (C) Where one fire pump is provided by the requirements of (B) above, the total capacity of a fire pump is not less than two thirds of the quantity required to be dealt with by each of the independent bilge pumps and capable of delivering for fire-fighting purposes such quantity. The minimum pressures of all hydrants are to be maintained at 0.3 MPa.
  - (D) Where passenger ships not engaged in international voyage and for restricted service, the requirements specified in **Ch 8, 101. 2** (1) (A) and (b) of the Rules may be omitted.
  - (E) Where passenger ships of less than 500 gross tonnage, the requirements for isolating valve specified in **Ch 8, 101. 4** (1) of the Rules may be omitted.
  - (F) Where passenger ships not engaged in international voyage and for restricted service, the requirements specified in **Ch 8, 101. 5** (2) (B) of the Rules may be omitted.
  - (G) Where passenger ships not engaged in international voyage and for restricted service, the requirements for "in interior locations in passenger ships carrying more than 36 passengers fire hoses shall be connected to the hydrants at all times." specified in **Ch 8, 103. 1** of the Rules may be omitted.
  - (H) Where passenger ships not engaged in international voyage and for restricted service, the requirements for water fog applicators specified in **Ch 8, 405.,, 902. 2. (2)** and **Ch 13, 502. 2. (1)** of the Rules may be omitted.
- (2) In application of **Ch 8, 203.** of the Rules, spare fire-extinguishing medium of capacity or weight that can be charged portable fire extinguishers may be provided not less than that obtained by multiplying the number of following table by the number of portable fire extinguishers in accordance with the requirements of this Guidance. In this cases, fire-extinguishing medium that has been charged in portable fire extinguishers provided exceeding the number in accordance with the requirements of this Guidance may be deemed spare charges.

Description	Arrangement ratio
Where passenger ships of not less than 1,000 gross tonnage, not engaged in international voyage and for restricted service	50 %
Where passenger ships of 100 gross tonnage and over but less than 1,000 gross tonnage, not engaged in international voyage and for restricted service	25 %
Where passenger ships of less than 100 gross tonnage, not engaged in international voyage and for restricted service	10 %

- (3) A fixed fire detection and fire alarm system may be loosened as follows.
- (A) Where passenger ships not engaged in international voyage and for restricted service, the requirements specified in **Ch 5, 101. 4** and **801.** of the Rules may be omitted.
  - (B) Where passenger ships carrying not more than 36 passengers, not engaged in international voyage and for restricted service, an automatic sprinkler, fire detection and fire alarm system specified in **Ch 5, 303.** of the Rules may be omitted.
  - (C) Where passenger ships not engaged in international voyage and for restricted service, fire detection and fire alarm system specified in **Ch 5, 304.** and **401.** of the Rules may be omitted.
  - (D) Where passenger ships of less than 1,000 gross tonnage and carrying more than 36 passengers, not engaged in international voyage and for restricted service, an automatic sprinkler, fire detection and fire alarm system specified in **Ch 5, 302.** and **Ch 8, 501. 1** of the Rules may be omitted.
  - (E) Where passenger ships not engaged in international voyage and for restricted service, the fixed fire detection and fire alarm system specified in **Ch 5, 201. 2 (2)** and **3** of the Rules

may be omitted. Spaces having little or no fire risk such as voids, public toilets, carbon dioxide rooms and similar spaces need not be fitted with a fixed fire detection and alarm system.

- (F) Where passenger ships not engaged in international voyage and for restricted service, the fixed fire detection and fire alarm system are to be provided at machinery spaces of fibre reinforced plastics ships (hereinafter to as "FRP ships") and having main engines (if the sum of rated power of internal combustion engine is 1,500 kW and over) that employ remote control.
  - (G) Where passenger ships carrying not more than 36 passengers and not engaged in international voyage and for restricted service, or Where passenger ships of less than 1,000 gross tonnage and carrying more than 36 passengers, not engaged in international voyage and for restricted service, manually operated call points specified in **Ch 5, 501.** of the Rules may be omitted.
  - (H) Where passenger ships not engaged in international voyage and for restricted service, a special alarm specified in **Ch 5, 701. 4** of the Rules may be omitted.
  - (I) Where passenger ships not engaged in international voyage and for restricted service, the fixed fire detection and fire alarm system are not capable of individually identifying the compartments.
- (4) Fire-extinguishing systems in accommodation, service spaces and control stations may be loosened as follows.
- (A) Where passenger ships of less than 1,000 gross tonnage, not engaged in international voyage and for restricted service, the requirements specified in **Ch 8, 504.** of the Rules may be omitted.
  - (B) Where passenger ships not engaged in international voyage and for restricted service, the requirements for exhaust ducts from galley ranges and main laundries specified in **Ch 7, 605.** of the Rules may be omitted.
  - (C) Where passenger ships of less than 1,000 gross tonnage, not engaged in international voyage and for restricted service, minimum two in each space, so located that there are at least one portable fire extinguisher within 15 m walking distance from any point. In this cases, One of the portable fire-extinguishers intended for use in any space are to be stowed near the entrance to that space.
- (5) Fire-extinguishing arrangements in machinery spaces may be loosened as follows.
- (A) Where passenger ships of less than 1,000 gross tonnage, not engaged in international voyage and for restricted service, machinery space containing oil fuel units (except oil-fired boilers) need not to be fitted with the fixed fire-extinguishing system specified in **Ch 8, 401. 1** of the Rules.
  - (B) Where passenger ships not engaged in international voyage and for restricted service, additional fire-extinguishing arrangements specified in **Ch 8, 401. 2** of the Rules may be omitted. In this cases, Each firing space in each boiler room and each space in which a part of the oil fuel installation is to be provided with at least one portable fire-extinguisher.
  - (C) Where passenger ships not engaged in international voyage and for restricted service, portable foam applicator unit in machinery space containing internal combustion machinery may be omitted.
  - (D) Where passenger ships not engaged in international voyage and for restricted service, oil-fired boilers are to be provided with one of the portable foam-type fire extinguishers having a total capacity of not less than 45 liters or carbon dioxide fire extinguishers having a total capacity of not less than 16 kg or dry powder extinguishers having a total capacity of not less than 23 kg.
  - (E) Where passenger ships not engaged in international voyage and for restricted service, workshops forming part of machinery spaces and other machinery spaces (auxiliary spaces, electrical equipment spaces, auto-telephone exchange rooms, air conditioning spaces and other similar spaces) specified in **Table 8.8.3** of the Guidance need not to be fitted with portable fire-extinguishers.
  - (F) Despite of the requirement of (E) above, each space containing hydraulic devices having total output of 3 kW and over or each space containing hydraulic oil tanks are to be provided with at least one portable fire extinguisher. Where any one of following is fulfilled, portable fire extinguishers may be omitted.
    - (a) hydraulic oil tank having total capacity of 100 liters and less
    - (b) hydraulic oil with a flashpoint of not less than 200 °C

- (G) Where passenger ships not engaged in international voyage and for restricted service, spaces containing internal combustion engines need not to be fitted with fixed fire extinguishing systems specified in **Ch 8, 401. 1** of the Rules. Where any one of following is fulfilled, fixed fire extinguishing systems are to be provided.
- Where passenger ships with the vehicle area are provided main engines having total capacity of 750 kW and over.
  - Where FRP ship's engine room is unattended and is provided main engines having total capacity of 1,500 kW and over.
- (H) Where passenger ships of less than 300 gross tonnage, not engaged in international voyage and for restricted service, portable fire extinguishers instead of foam-type fire extinguishers of 45 liters capacity specified in **Ch 8, 402. 2 (2)** of the Rules in spaces containing internal combustion engines may be provided in accordance with following table.

Description		minimum number of extinguishers
ships of less than 50 gross tonnage		Quantity : one portable fire extinguisher Location : entrance of engine room
ships of 50 gross tonnage and over but less than 300	Where main engines or auxiliary engines having total capacity of less than 750 kW	Quantity : two portable fire extinguisher Location : easily accessible location
	Where main engines or auxiliary engines having total capacity of not less than 750 kW	Quantity : three portable fire extinguisher Location : easily accessible location

- (I) Where passenger ships not engaged in international voyage and for restricted service, fixed local application fire-fighting system specified in **Ch 8, 406.** of the Rules may be omitted.
- (6) Fire-extinguishing arrangements in cargo spaces may be loosened as follows.
- Where passenger ships not engaged in international voyage and for restricted service, fixed fire extinguishing system of cargo spaces specified in **Ch 8, 601. 1** and **2** of the Rules may be omitted.
- (7) Fire-fighter's outfit may be loosened as follows.
- Where passenger ships not engaged in international voyage and for restricted service, fire-fighter's outfit may be omitted. But, ships in which motor vehicles with fuel in their tanks for their own propulsion are to be complied as follow:
    - Where passenger ships with enclosed vehicle spaces: 2
    - Where passenger ships of not less than 100 gross tonnage and with opened vehicle spaces: 1
    - Where passenger ships of less than 100 gross tonnage and with opened vehicle spaces: one axe and one lifeline
  - Where FRP passenger ships of 30 gross tonnage and over but less than 100, not engaged in international voyage and for restricted service, are provided additionally one breathing apparatus.
  - Where passenger ships not engaged in international voyage and for restricted service, emergency escape breathing devices may be omitted. In this cases, passenger ships of not less than 1,600 gross tonnage are provided with at least three emergency escape breathing devices (including one spare) in accommodation and at least two emergency escape breathing devices in machinery spaces.
- (8) Where passenger ships of less than 500 gross tonnage, international shore connections may be omitted.
- (9) Where passenger ships not engaged in international voyage and for restricted service, periodically unattended machinery space are to be provided as follows.
- Automatic fire extinguishing system in accordance with FSS Code or fixed fire extinguishing system specified in **Ch 8, 301. 1** of the Rules, fixed fire detection and fire alarm systems specified in **Ch 5, 202.** of the Rules are to be provided. Where steel ships, it can be replaced by providing fixed fire detection systems, fixed fire alarm systems and at least two portable dry-powder fire extinguishers (ABC-class) or at least two portable carbon-dioxide fire extinguishers at each entrance of machinery spaces.
  - Following fire extinguishing arrangements are to be provided. Minimum two in each spaces,

so located that there are at least one portable fire extinguisher specified in (b) within 10 m walking distance from any point.

(a) One of the portable foam-type fire extinguishers having a total capacity of not less than 45 liters or carbon dioxide fire extinguishers having a total capacity of not less than 16 kg or dry powder extinguishers having a total capacity of not less than 23 kg.

(b) At least two portable fire extinguishers

(C) Where any one of following is fulfilled despite of the requirement of (A) above, machinery space containing internal combustion engines are to be provided with fixed fire extinguishing system specified in **Ch 8, 301. 1** of the Rules.

(a) Where passenger ships with the vehicle area are provided main engines having total capacity of 750 kW or over.

(b) Where FRP passenger ship's engine room is unattended and is provided main engines having total capacity of 1,500 kW or over.

(10) Where passenger ships not engaged in international voyage and for restricted service, fire-fighting appliances of the helideck specified in **Ch 11, 401.** of the Rules may be omitted.

(11) Fire-extinguishing arrangements in vehicle and ro-ro spaces may be loosened as follows.

(A) Where passenger ships not engaged in international voyage and for restricted service, enclosed vehicle spaces may omit water fog applicators specified in **Ch 13, 502. 2 (1)** of the Rules.

(B) In application of **Ch 13, 301.** of the Rules, fixed fire detection and fire alarm systems on weather decks may be omitted.

3. For cargo ships, such ships may be also loosened as follows.

(1) Fire pumps, etc may be loosened as follows.

(A) Where cargo ships of less than 300 gross tonnage, not engaged in international voyage and for restricted service, fire pumps specified in **Ch 8, 102. 2 (2)** of the Rules may be omitted.

(B) Where cargo ships of not less than 300 gross tonnage, not engaged in international voyage and for restricted service or where cargo ships of 300 gross tonnage and over but less than 500 gross tonnage, one independent fire pump driven by power specified in **Ch 8, 102. 2 (2)** of the Rules may be provided.

(C) Where cargo ships not engaged in international voyage and for restricted service or where cargo ships of less than 500 gross tonnage, are to be provided two fire pumps, the total capacity of fire pumps is not less than two thirds of the quantity required to be dealt with by each of the independent bilge pumps and capable of delivering for fire-fighting purposes such quantity. But the total required capacity of the fire pumps need not to exceed 180 m<sup>3</sup>/h.

(D) Where one fire pump is provided by the requirements of (B) above, the total capacity of a fire pump is not less than two thirds of the quantity required to be dealt with by each of the independent bilge pumps and capable of delivering for fire-fighting purposes such quantity. The minimum pressures of all hydrants are to be maintained at 0.24 MPa.

(E) Where cargo ships not engaged in international voyage and for restricted service or where cargo ships of less than 500 gross tonnage, the requirements for emergency fire pump may be omitted.

(F) Where cargo ships of not less than 300 gross tonnage, not engaged in international voyage and for restricted service or where cargo ships of 300 gross tonnage and over but less than 500 gross tonnage, the number and position of hydrants are to be such that at least one jet of water by a single length of hose. In this cases, it may reach any part of the ship normally accessible to the passengers or crew while the ships is being navigated and any part of any cargo space when empty.

(G) Where cargo ships of less than 300 gross tonnage, the requirements for the number and position of hydrants specified in **Ch 8, 101. 5** of the Rules may be omitted.

(H) Where cargo ships of less than 1,000 gross tonnage or where cargo ships not engaged in international voyage and for restricted service, spare fire hoses and nozzles specified in **Ch 8, 103. 2 (3)** of the Rules may be omitted.

(I) Where cargo ships of less than 300 gross tonnage, the requirements specified in **Ch 8, 103. 2. (3)** may be omitted.

(J) Where cargo ships not engaged in international voyage and for restricted service or where cargo ships of less than 500 gross tonnage, the requirements for isolating valves specified in **Ch 8, 101. 4 (1)** of the Rules may be omitted.

(2) In application of **Ch 8, 203.** of the Rules, spare fire-extinguishing medium of capacity or weight

that can be charged portable fire extinguishers may be provided not less than that obtained by multiplying the number of following table by the number of portable fire extinguishers in accordance with the requirements of this Guidance. In this cases, fire-extinguishing medium that has been charged in portable fire extinguishers provided exceeding the number in accordance with the requirements of this Guidance may be deemed spare charges.

Description	Arrangement ratio
Where cargo ships not engaged in international voyage and for restricted service or where cargo ships of less than 500 gross tonnage	10 %

- (3) A fixed fire detection and fire alarm system may be loosened as follows.
- (A) Where cargo ships not engaged in international voyage and for restricted service or where cargo ships of less than 500 gross tonnage, fixed fire detection and fire alarm systems specified in **Ch 5, 201. 2 (2) and 3** of the Rules may be omitted. Spaces having little or no fire risk such as voids, public toilets, carbon dioxide rooms and similar spaces need not be fitted with a fixed fire detection and alarm system.
  - (B) Where cargo ships not engaged in international voyage and for restricted service or where cargo ships of less than 500 gross tonnage, manually operated call points specified in **Ch 5, 501.** of the Rules may be omitted.
  - (C) Where cargo ships not engaged in international voyage and for restricted service or where cargo ships of less than 500 gross tonnage, n automatic sprinkler, fire detection and fire alarm systems specified in **Ch 5, 305.** of the Rules may be omitted.
- (4) Fire-extinguishing systems in accommodation, service spaces and control stations may be loosened as follows.
- (A) Where cargo ships not engaged in international voyage and for restricted service or where cargo ships of less than 500 gross tonnage, the requirements specified in **Ch 8, 504.** of the Rules may be omitted.
  - (B) Where cargo ships not engaged in international voyage and for restricted service or where cargo ships of less than 500 gross tonnage, the requirements for exhaust ducts from galley ranges and main laundries specified in **Ch 7, 605.** of the Rules may be omitted.
  - (C) In application of **Ch 8, 202.** of the Rules, at least four portable fire extinguishers for ships of 500 gross tonnage and over but less than 1,000 gross tonnage, at least three portable fire extinguishers for ships of 100 gross tonnage and over but less than 500 gross tonnage, at least two portable fire extinguishers for ships of 50 gross tonnage and over but less than 100 gross tonnage, and at least one portable fire extinguisher for ships of less than 50 gross tonnage, are to be provided in accommodation and service spaces as appropriate.
- (5) Fire-extinguishing arrangements in machinery spaces may be loosened as follows.
- (A) Where cargo ships of less than 1,000 gross tonnage, not engaged in international voyage and for restricted service or where cargo ships of less than 500 gross tonnage, machinery space containing oil fuel units (except oil-fired boilers) need not to be fitted with the fixed fire-extinguishing system specified in **Ch 8, 401.** of the Rules.
  - (B) Where cargo ships of less than 500 gross tonnage, the fixed low-expansion foam fire-extinguishing systems as the fixed fire-extinguishing systems may be provided.
  - (C) Where cargo ships not engaged in international voyage and for restricted service or where cargo ships of less than 500 gross tonnage, additional fire-extinguishing arrangements specified in **Ch 8, 401. 2** of the Rules may be omitted. In this cases, Each firing space in each boiler room and each space in which a part of the oil fuel installation is to be provided with at least one portable fire-extinguisher.
  - (D) Where cargo ships of less than 500 gross tonnage, spaces containing internal combustion engines need not to be fitted with the fixed fire extinguishing system specified in **Ch 8, 402. 1** of the Rules. However, in ships of less than 500 gross tonnage and having cargo spaces intended for the carriage of motor vehicles with fuel in their tanks for their own-propulsion (except ships registered with the notation "S"), this requirement is not to apply for places containing internal combustion engines (only those of their total output of not less than 750 kW for main propulsion).
  - (E) Where cargo ships not engaged in international voyage and for restricted service or where



cargo ships of less than 500 gross tonnage, portable foam applicator unit in machinery space containing internal combustion machinery may be omitted.

- (F) Where cargo ships of less than 1,000 gross tonnage, not engaged in international voyage and for restricted service or where cargo ships of less than 500 gross tonnage, machinery spaces containing internal combustion engines need not to be fitted with the portable foam-type fire extinguishers having a total capacity of not less than 45 liters specified in **Ch 8, 402. 2 (2)** of the Rules.
- (G) Where cargo ships not engaged in international voyage and for restricted service or where cargo ships of less than 500 gross tonnage, workshops forming part of machinery spaces and other machinery spaces (auxiliary spaces, electrical equipment spaces, auto-telephone exchange rooms, air conditioning spaces and other similar spaces) specified in **Table 8.8.3** of the Guidance need not to be fitted with portable fire-extinguishers.
- (H) Despite of the requirement of (G) above, each space containing hydraulic devices having total output of 3 kW or over or each space containing hydraulic oil tanks are to be provided with at least one portable fire extinguisher. Where any one of following is fulfilled, portable fire extinguishers may be omitted.
- (a) hydraulic oil tank having total capacity of 100 liters or less
  - (b) hydraulic oil with a flashpoint of not less than 200°C
- (6) Fire-extinguishing arrangements in cargo spaces may be loosened as follows.
- (A) Where cargo ships of less than 2,000 gross tonnage (except tankers), cargo spaces need not to be fitted with fixed fire extinguishing systems specified in **Ch 8, 601. 3** of the Rules. But, this requirement is not to apply to vehicle and ro-ro spaces.
- (7) Fire-fighter's outfit may be loosened as follows.
- (A) Where cargo ships not engaged in international voyage and for restricted service or where cargo ships of less than 500 gross tonnage, fire-fighter's outfit may be omitted. But, ships in which motor vehicles with fuel in their tanks for their own propulsion are to be complied as follow:
- (a) Where cargo ships with enclosed vehicle spaces : 2
  - (b) Where cargo ships of not less than 100 gross tonnage and with opened vehicle spaces : 1
  - (c) Where cargo ships of less than 100 gross tonnage and with opened vehicle spaces : one axe and one lifeline
- (B) Where cargo ships not engaged in international voyage and for restricted service or where cargo ships of less than 500 gross tonnage, emergency escape breathing devices may be omitted.
- (8) Where cargo ships not engaged in international voyage and for restricted service or where cargo ships of less than 500 gross tonnage, international shore connections may be omitted.
- (9) Where cargo ships not engaged in international voyage and for restricted service or where cargo ships of less than 500 gross tonnage, periodically unattended machinery space may be loosened as follows.
- (A) The fixed fire detection and fire alarm system specified in **Ch 5, 201. 1** of the Rules may be omitted.
- (B) Fire extinguishing system are to be provided as follows.
- (a) Automatic fire extinguishing system in accordance with FSS Code or fixed fire extinguishing system specified in **Ch 8, 301. 1** of the Rules, fixed fire detection and fire alarm systems specified in **Ch 5, 202.** of the Rules are to be provided. Where steel ships, it can be replaced by providing fixed fire detection systems, fixed fire alarm systems and at least two portable dry-powder fire extinguishers (ABC-class) or at least two portable carbon-dioxide fire extinguishers at each entrance of machinery spaces.
  - (b) Following fire extinguishing arrangements are to be provided. Minimum two in each spaces, so located that there are at least one portable fire extinguisher specified in (ii) within 10 m walking distance from any point.
    - (i) One of the portable foam-type fire extinguishers having a total capacity of not less than 45 liters or carbon dioxide fire extinguishers having a total capacity of not less than 16 kg or dry powder extinguishers having a total capacity of not less than 23 kg.
    - (ii) At least two portable fire extinguishers
  - (c) Where any one of following is fulfilled despite of the requirement of (A) above, machinery space containing internal combustion engines are to be provided with fixed fire extinguishing system specified in **Ch 8, 301. 1** of the Rules.

- (i) Where cargo ships with the vehicle area are provided main engines having total capacity of 750 kW or over.
  - (ii) Where FRP cargo ship's engine room is unattended and is provided main engines having total capacity of 1,500 kW or over.
- (C) The requirements specified in **Ch 8, 101. 2 (2)** of the Rules may be omitted.
- (10) Fire-extinguishing arrangements for tankers may be loosened as follows.
- (A) Where tankers of less than 500 gross tonnage, pump room need not to be provided with the fixed fire extinguishing system specified in **Ch 8, 801.** of the Rules.
  - (B) Where tankers of less than 500 gross tonnage, deck foam system specified in **Ch 8, 701.** of the Rules may be omitted.
- (11) Where cargo ships not engaged in international voyage and for restricted service or where cargo ships of less than 500 gross tonnage, fire-fighting appliances of the helideck specified in **Ch 11, 401.** of the Rules may be omitted.
- (12) The cargo ships (cargo ferries, etc.) provided with spaces to carry motor vehicles with fuel in their tanks for their own propulsion (hereinafter referred as "car spaces"), are to comply with the Guidance **Pt 7, Annex 7-3 10 (2)**.
- (13) In applying **Ch 2, 403. 2 (2)** of the Rules, the alleviation provision for isolation requirement of cargo oil tank for tankers of less than 500 ton gross tonnage as follows ;  
Where the arrangements are the plural cargo oil tank and each cargo oil tank of less than 10 mm length, these plural cargo oil tank may be regarded as one cargo oil tank.  
(See **Fig Annex 8-3**)

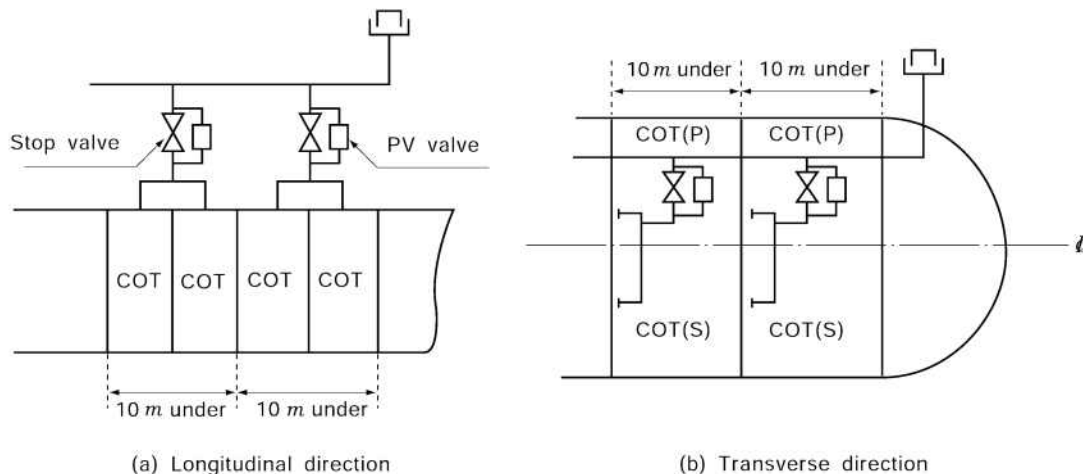

**Fig. Annex 8-3 Isolation of cargo oil tank for tankers of less than 500 ton gross tonnage**

- (14) In application of **Ch 9, 503. 2** of the Rules, where oil tankers not engaged in international voyage and for restricted service, a secondary means for over-pressure or under-pressure protection may be omitted.
- (15) Fire-extinguishing arrangements in vehicle and ro-ro spaces may be loosened as follows.
- (A) Where cargo ships not engaged in international voyage and for restricted service or where cargo ships of less than 500 gross tonnage, the requirements specified in **Ch 13, 502. 2** of the Rules may be omitted.
  - (B) Where cargo ships not engaged in international voyage, for restricted service and for carrying non-combustible cargoes exclusively in vehicle and ro-ro spaces, fixed fire extinguishing systems specified in **Ch 13, 501.** of the Rules may be omitted.
  - (C) Where cargo ships not engaged in international voyage and for restricted service or where cargo ships of less than 500 gross tonnage, vehicle and ro-ro spaces are capable of being sealed from a location outside of the cargo spaces need not to be provided with fixed fire extinguishing systems specified in **Ch 13, 501.** of the Rules.
  - (D) Where cargo ships not engaged in international voyage and for restricted service, enclosed vehicle and ro-ro spaces need not to be provided with portable combustible gas detecting instruments specified in **Ch 13, 201. 2 (2)** of the Rules.
  - (E) Where cargo ships not engaged in international voyage and for restricted service or where cargo ships of less than 500 gross tonnage, vehicle and ro-ro spaces are to be provided

with the fixed fire detection and fire alarm systems specified in **Ch 13, 301.** of the Rules. If an efficient fire patrol system are to be maintained by a continuous fire watch at all times during the voyage, the fixed fire detection and fire alarm systems may be omitted.

## Annex 8-4 Alleviation Requirements for Fishing Vessels

1. Fire pumps may be also loosened as follows.
  - (1) At least two 2 for fishing vessels of not less than 1,000 gross tonnage, at least one for fishing vessels of 80 gross tonnage and over but less than 1,000 gross tonnage, fishing vessels of less than 80 gross tonnage need not to be provided with fire pumps.
  - (2) Where fishing vessels of not less than 1,000 gross tonnage, the total capacity of such fire pumps is not less than two thirds of the quantity required to be dealt with by each of the independent bilge pumps and capable of delivering for fire-fighting purposes such quantity. But the total required capacity of the fire pumps need not to exceed 180 m<sup>3</sup>/h.
  - (3) Where fishing vessels of 500 gross tonnage or over but less than 1,000 gross tonnage is provided with one fire pump in accordance with the requirements of (1) above, the total capacity of a fire pump is not less than two thirds of the quantity required to be dealt with by each of the independent bilge pumps and capable of delivering for fire-fighting purposes such quantity. The minimum pressures of all hydrants are to be maintained at 0.24 MPa.
  - (4) Where fishing vessels of less than 500 gross tonnage, with a periodically unattended machinery space or when only one person is required on watch, the requirements specified in **Ch 8, 101. 2 (2)** of the Rules may be omitted.
2. The requirements of Emergency fire pumps may be not apply to fishing vessels.
3. Hydrants may be also loosened as follows.
  - (1) For fishing vessels of less than 80 gross tonnage, the requirements for the number and position of hydrants specified in **Ch 8, 101. 5** of the Rules may be omitted.
  - (2) Where fishing vessels of 80 gross tonnage or over but less than 5000 gross tonnage, The number and position of hydrants are to be such that at least one jets of water not emanating from the same hydrant, one jet of water is to be from a single length of hose, may reach any part of the ship normally accessible to the passengers or crew while the ship is being navigated and any part of any cargo space when empty. In this cases, the minimum pressure is to be sufficient to produce a 12 m jet throw, through any adjacent hydrants.
  - (3) The requirements for the minimum pressure specified in **Ch 8, 101. 6** of the Rules and for the capacity of fire pumps specified in **Ch 8, 102. 4** of the Rules may be omitted.
  - (4) The requirements of isolating valve, which is installed in machinery space to separate the section of the fire main within the machinery space containing the main fire pump from the rest of fire main, may not be applied to.
4. Fire hoses and nozzles may be loosened as follows.
  - (1) For fishing vessels less than 80 gross tonnage, the requirement for fire hose and nozzle specified in **Ch 8, 103. 2** of the Rules may be omitted.
  - (2) For fishing vessels of 80 gross tonnage and over but less than 1,000 gross tonnage, spare fire hoses and nozzles specified in **Ch 8, 103. 2 (3)** of the Rules may be omitted.
5. Fire-fighter's outfit may be loosened as follows.
  - (1) For fishing vessels of not less than 1,000 gross tonnage, at least one fire-fighter's outfit in accordance with FSS Code may be provided.
6. Fixed fire detection and fire alarm systems need not apply to fishing vessels. For vessels apply to the Fishing Vessel Act is to be complied with Regulations for Fishing Vessel's Equipment" in Korean Fishing Vessel Act. (2021)
7. Fire-extinguishing systems in accommodation and service spaces and control stations may be loosened as follows.
  - (1) For fishing vessels less than 1,000 gross tonnage, the requirements of fixed extinguishing system for exhaust ducts from galley ranges may be omitted.
  - (2) At least one portable fire extinguisher for fishing vessels of 20 gross tonnage, at least two portable fire extinguishers for fishing vessels of 20 gross tonnage or over but less than 80 gross tonnage, at least three portable fire extinguishers for fishing vessels of 80 gross tonnage or over but less than 500 gross tonnage, at least four portable fire extinguishers for fishing vessels of 500 gross tonnage or over but less than 1,000 gross tonnage, are to be provided. In this cases, where fishing vessels of not less than 500 gross tonnage, one of the portable fire-extinguishers intended for use in any space are to be stowed near the entrance to that space.

8. Fire-extinguishing arrangement in machinery spaces may be also loosened as follows.
- (1) For fishing vessels of not less than 1,000 gross tonnage, machinery spaces containing internal combustion engines are to be provided following fire extinguishing systems.
    - (A) One of the fixed fire extinguishing systems specified in **Ch 8, 301. 1** of the Rules
    - (B) One of the portable foam-type fire extinguishers having a total capacity of not less than 45 liters or carbon dioxide fire extinguishers having a total capacity of not less than 16 kg or dry powder extinguishers having a total capacity of not less than 23 kg.
    - (C) In addition at least a portable foam fire extinguisher per output of 750 kW of internal combustion engines or each engine is to be provided.
  - (2) For fishing vessels of less than 1,000 gross tonnage, machinery spaces containing internal combustion engines may be permitted following requirements instead of the requirements specified in (1) above.
    - (A) At least a portable foam fire extinguisher per output of 750 kW of internal combustion engines or each engine is to be provided.
    - (B) At least one portable fire extinguisher for fishing vessels of 80 gross tonnage, at least two portable fire extinguishers for fishing vessels of 80 gross tonnage or over but less than 500 gross tonnage, at least three portable fire extinguishers for fishing vessels of 500 gross tonnage or over but less than 1,000 gross tonnage, are to be provided.
    - (C) The periodically unattended machinery space is to be provided with the one of following fire extinguishing arrangements. But, where steel ships, it can be replaced by providing fixed fire detection systems, fixed fire alarm systems and at least two portable dry-powder fire extinguishers (ABC-class) or at least two portable carbon-dioxide fire extinguishers at each entrance of machinery spaces.
      - (a) One of the fixed fire extinguishing systems specified in **Ch 8, 301. 1** of the Rules
      - (b) An automatic fire extinguishing system with sufficient capacity in accordance with the FSS Code
      - (c) The fixed fire detection and fire alarm systems specified in **Ch 5, 202.** of the Rules
  - (3) Machinery spaces containing oil-fired boilers or oil fuel units may be loosened as follows.
    - (A) For fishing vessels of less than 1,000 gross tonnage, spaces containing oil fuel units (except oil-fired boilers) need not to be provided with the fixed fire extinguishing systems specified in **Ch 8, 401. 1** of the Rules.
    - (B) Each firing space in each boiler room and each space in which a part of the oil fuel installation is to be provided with at least one portable fire-extinguisher.
    - (C) In each firing space there shall be a receptacle containing at least 0.1 m<sup>3</sup> sand, sawdust impregnated with soda, or other approved dry material, along with a suitable shovel for spreading the material. An approved portable extinguisher may be substituted as an alternative.
    - (D) Despite of the requirements specified in (A) to (C) above, for fishing vessels of less than 500 gross tonnage, the fire extinguishing arrangement above which considered acceptable by the Society may be loosened in consideration of the capacity and position of oil-fired boilers.

#### 9. Spare fire-extinguishing medium

Spare chargers are to be provided for 50 % of the fire extinguishers capable of being recharged on board. In this cases, fire-extinguishing medium that has been charged in portable fire extinguishers provided exceeding the number in accordance with the requirements of this Guidance may be deemed spare charges.

10. For fishing vessels equipped with helidecks, in close proximity to the helideck, the following fire-fighting appliances are to be provided and stored near the means of access to that helideck:
- (1) At least two dry powder extinguishers having a total capacity of not less than 45 kg;
  - (2) Carbon dioxide extinguishers of a total capacity of not less than 18 kg or equivalent;
11. The requirements of International shore connection may be omitted.
12. The requirements of Fire control plans may be omitted.
13. The requirements of Fire-extinguishing arrangements in cargo spaces may be omitted.
14. Besides the above paragraphs, the fishing vessel which is not engaged in international voyage and Ships of less than 500 gross tonnage shall be complied with the requirements of **Annex 8-3**.

## Annex 8-5 Inert Gas Systems

### 1. Definitions

- (1) Cargo tanks means those cargo tanks, including slop tanks, which carry cargoes, or cargo residues, having a flash point not exceeding 60 °C.
- (2) Inert gas system includes inert gas systems using flue gas, inert gas generators, and nitrogen generators and means the inert gas plant and inert gas distribution together with means for preventing back flow of cargo gases to machinery spaces, fixed and portable measuring instruments and control devices.
- (3) Gas-safe space is a space in which the entry of gases would produce hazards with regard to flammability or toxicity.
- (4) Gas-free is a condition in a tank where the content of hydrocarbon or other flammable vapour is less than 1% of the lower flammable limit(LFL), the oxygen content is at least 21%, and no toxic gases are present.

### 2. General requirements

- (1) The system shall be capable of inerting empty cargo tanks and maintaining the atmosphere in any part of the tank with an oxygen content not exceeding 8% by volume and at a positive pressure in port and at sea except when it is necessary for such a tank to be gas-free;
- (2) The system shall be capable of eliminating the need for air to enter a tank during normal operations except when it is necessary for such a tank to be gas-free;
- (3) The system shall be capable of purging empty cargo tanks of hydrocarbon or other flammable vapours, so that subsequent gas-freeing operations will at no time create a flammable atmosphere within the tank;
- (4) The system shall be capable of delivering inert gas to the cargo tanks at a rate of at least 125% of the maximum rate of discharge capacity of the ship expressed as a volume. For chemical tankers and chemical/product tankers, the Society may accept inert gas systems having a lower delivery capacity provided that the maximum rate of discharge of cargoes from cargo tanks being protected by the system is restricted to not more than 80 % of the inert gas capacity; and
- (5) The system shall be capable of delivering inert gas with an oxygen content of not more than 5% by volume to the cargo tanks at any required rate of flow.
- (6) Materials used in inert gas systems shall be suitable for their intended purpose. In particular, those components which may be subjected to corrosive action of the gases and/or liquids are to be either constructed of corrosion-resistant material or lined with rubber, glass fibre epoxy resin or other equivalent coating material.
- (7) The inert gas supply may be:
  - (A) treated flue gas from main or auxiliary boilers, or
  - (B) gas from an oil or gas-fired gas generator, or
  - (C) gas from nitrogen generators.Inert gas system using stored carbon dioxide will not be permitted unless the Society is satisfied that there is no risk of ignition from generation of static electricity by the system itself.
- (8) Safety measures
  - (A) The inert gas system shall be so designed that the maximum pressure which it can exert on any cargo tank will not exceed the test pressure of any cargo tank.
  - (B) Automatic shutdown of the inert gas system and its components parts shall be arranged on predetermined limits being reached, taking into account the provisions of (11), 3 (7) and 4 (5). The automatic shut-down of the inert gas system and its components shall involve the following: (2019)
    - (a) Shut-down of fans and closing of regulating valve for the following:
      - (i) High water level in scrubber (not applicable for N2)
      - (ii) Low pressure/flow to scrubber (not applicable for N2)
      - (iii) High-high temperature of inert gas supply
    - (b) Closing of regulating valve in the event of:
      - (i) High oxygen content (in excess of 5% by volume)
      - (ii) Failure of blowers/fans or N2 compressors
    - (c) Activation of double-block and bleed arrangement upon (for ships with double block and bleed replacing water seal):
      - (i) Loss of inert gas supply

- (ii) Loss of power
  - (C) Suitable shutoff arrangements shall be provided on the discharge outlet of each generator plant.
  - (D) The system shall be designed to ensure that if the oxygen content exceeds 5% by volume, the inert gas shall be automatically vented to atmosphere.
  - (E) Arrangements shall be provided to enable the functioning of the inert gas plant to be stabilized before commencing cargo discharge. If blowers are to be used for gas-freeing, their air inlets shall be provided with blanking arrangements.
  - (F) Where a double block and bleed valve is installed, the system shall ensure upon loss of power, the block valves are automatically closed and the bleed valve is automatically open.
- (9) Non-return devices
- (A) At least two non-return devices shall be fitted in order to prevent the return of vapour and liquid to the inert gas plant, or to any gas-safe spaces.
  - (B) The first non-return device shall be a deck seal of the wet, semi-wet, or dry type or a double-block and bleed arrangement. Two shut-off valves in series with a venting valve in between, may be accepted provided:
    - (a) the operation of the valve is automatically executed. Signal(s) for opening/closing is (are) to be taken from the process directly, e.g. inert gas flow or differential pressure; and
    - (b) alarm for faulty operation of the valves is provided, e.g. the operation status of "blower stop" and "supply valve(s) open" is an alarm condition.
  - (C) The second non-return device shall be a non-return valve or equivalent capable of preventing the return of vapours and liquids and fitted between the deck water seal (or equivalent device) and the first connection from the inert gas main to a cargo tank. It shall be provided with positive means of closure. As an alternative to positive means of closure, an additional valve having such means of closure may be provided between the non-return valve and the first connection to the cargo tanks to isolate the deck water seal, or equivalent device, from the inert gas main to the cargo tanks.
  - (D) A water seal, if fitted, shall be capable of being supplied by two separate pumps, each of which shall be capable of maintaining an adequate supply at all times. The audible and visual alarm on the low level of water in the water seal shall operate at all times.
  - (E) The arrangement of the water seal, or equivalent devices, and its associated fittings shall be such that it will prevent backflow of vapours and liquids and will ensure the proper functioning of the seal under operating conditions.
  - (F) Provision shall be made to ensure that the water seal is protected against freezing, in such a way that the integrity of seal is not impaired by overheating.
  - (G) A water loop or other approved arrangement shall also be fitted to each associated water supply and drain pipe and each venting or pressure-sensing pipe leading to gas-safe spaces. Means shall be provided to prevent such loops from being emptied by vacuum.
  - (H) Any water seal, or equivalent device, and loop arrangements shall be capable of preventing return of vapours and liquids to an inert gas plant at a pressure equal to the test pressure of the cargo tanks.
  - (I) The non-return devices shall be located in the cargo area on deck.
- (10) Inert gas lines
- (A) The inert gas main may be divided into two or more branches forward of the non-return devices required by (9).
  - (B) The inert gas supply main shall be fitted with branch piping leading to each cargo tank. Branch piping for inert gas shall be fitted with either stop valves or equivalent means of control for isolating each tank. Where stop valves are fitted, they shall be provided with locking arrangements, which shall be under the control of a responsible ship's officer. The control system operated shall provide unambiguous information of the operational status of such valves to at least the control panel required in (11). Unambiguous information regarding the operational status of stop valves in branch piping leading from the inert gas main to cargo tanks means position indicators providing open/intermediate/closed status information in the control panel required in (11). Limit switches are to be used to positively indicate both open and closed position. Intermediate position status is to be indicated when the valve is in neither open nor closed position. (2019)
  - (C) Each cargo tank not being inerted shall be capable of being separated from the inert gas main by:
    - (a) removing spool-pieces, valves or other pipe sections, and blanking the pipe ends; or

- (b) arrangement of two spectacle flanges in series with provisions for detecting leakage into the pipe between the two spectacle flanges
- (c) equivalent arrangements to the satisfaction of the Administration, providing at least the same level of protection. (2021)
- (D) Means shall be provided to protect cargo tanks against the effect of overpressure or vacuum caused by thermal variations when the cargo tanks are isolated from the inert gas mains.
- (E) Piping systems shall be so designed as to prevent the accumulation of cargo or water in the pipelines under all normal conditions.
- (F) Arrangements shall be provided to enable the inert gas main to be connected to an external supply of inert gas. The arrangements shall consist of a 250 mm nominal pipe size bolted flange, isolated from the inert gas main by a valve and located forward of the non-return valve. The design of the flange should conform to the appropriate class in the standards adopted for the design of other external connections in the ship's cargo piping system.
- (G) If a connection is fitted between the inert gas supply main and the cargo piping system, arrangements shall be made to ensure an effective isolation having regard to the large pressure difference which may exist between the systems. This shall consist of two shutoff valves with an arrangement to vent the space between the valves in a safe manner or an arrangement consisting of a spool-piece with associated blanks. (see **Fig Annex 8-5**)
- (H) The valve separating the inert gas supply main from the cargo main and which is on the cargo main side shall be a non-return valve with a positive means of closure. As a guide, the effective isolation required by this regulation may be achieved by the two arrangements shown in the following sketches attached **Fig Annex 8-5.2**.

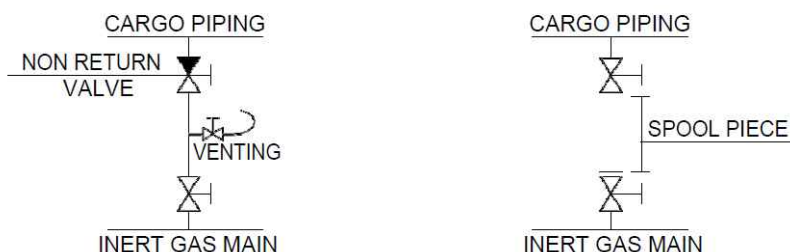

Fig. Annex 8-5.2

- (I) Inert gas piping systems shall not pass through accommodation, service and control station spaces.
- (J) In combination carriers, the arrangement to isolate the slop tanks containing oil or oil residues from other tanks shall consist of blank flanges which will remain in position at all times when cargoes other than oil are being carried except as provided for in the relevant section of the Guidelines on Inert Gas Systems (MSC/Circ.353 and MSC/Circ.387).
- (K) Piping of inert gas system shall have electrical continuity over their entire lengths including couplings and flanges (except shore connections) and be so designed as to minimize the risk of ignition from the generation of static electricity by itself. (2019)
- (11) Indicators and alarms
  - (A) The operation status of the inert gas system shall be indicated in a control panel. The operational status of the inert gas system is to be based on indication that inert gas is being supplied downstream of the gas regulating valve and on the pressure or flow of the inert gas mains downstream of the non-return devices. However, the operational status of the IG system is not to be considered to require additional indicators and alarms other than those specified in the 2 (11) and 3 (7) or 4 (9), as appropriate. (2019)
  - (B) Instrumentation shall be fitted for continuously indicating and permanently recording, when inert gas is being supplied:
    - (a) the pressure of the inert gas supply mains forward of the non-return devices; and
    - (b) the oxygen content of the inert gas.
  - (C) The indicating and recording devices shall be placed in the cargo control room where provided. But where no cargo control room is provided, they shall be placed in a position easily accessible to the officer in charge of cargo operations.
  - (D) In addition, meters shall be fitted:



- (a) in the navigating bridge to indicate at all times the pressure referred to in (11) (B) (a) and the pressure in the slop tanks of combination carriers, whenever those tanks are isolated from the inert gas supply main; and
  - (b) in the machinery control room or in the machinery space to indicate the oxygen content referred to in (11) (B) (b).
- (E) Audible and visual alarms
- (a) Audible and visual alarms shall be provided, based on the system designed, to indicate:
    - (i) oxygen content in excess of 5% by volume;
    - (ii) failure of the power supply to the indicating devices as referred to in (11) (B);
    - (iii) gas pressure less than 100 mm water gauge. The alarm arrangement shall be such as to ensure that the pressure in slop tanks in combination carriers can be monitored at all times;
    - (iv) high-gas pressure; and
    - (v) failure of the power supply to the automatic control system.
  - (b) The alarms required in (11) (E) (a) (i), (11) (E) (a) (iii) and (11) (E) (a) (v) shall be fitted in the machinery space and cargo control room, where provided, but in each case in such a position that they are immediately received by responsible members of the crew.
  - (c) An audible alarm system independent of that required in (11) (E) (a) (iii) or automatic shutdown of cargo pumps shall be provided to operate on predetermined limits of low pressure in the inert gas main being reached. The term "independent alarm system" means that a second pressure sensor, independent of the sensor serving the alarms for low pressure, high pressure and pressure indication/recorder is to be provided. Notwithstanding the above, a common programmable logic controller (PLC) is, however, accepted for the alarms in the control system. The independent sensor is not required if the system is arranged for the shutdown of cargo pumps. If a system for shutdown of cargo pumps is arranged, an automatic system shutting down all cargo pumps is to be provided. The shutdown is to be alarmed at the control station. The shutdown shall not prevent the operation of ballast pumps or pumps used for bilge drainage of a cargo pump room. (2019)
  - (d) Two oxygen sensors shall be positioned at appropriate locations in the space or spaces containing the inert gas system. If the oxygen level falls below 19%, these sensors shall trigger alarms, which shall be both visible and audible inside and outside the space or spaces and shall be placed in such a position that they are immediately received by responsible members of the crew.

(12) Instruction manuals

Detailed instruction manuals shall be provided on board, covering the operations, safety and maintenance requirements and occupational health hazards relevant to the inert gas system and its application to the cargo tank system. The manuals shall include guidance on procedures to be followed in the event of a fault or failure of the inert gas system. (MSC/Circ.353 and MSC/Circ.387)

### 3. Requirements for flue gas and inert gas generator systems

(1) Inert gas generator

- (A) Two fuel oil pumps shall be fitted to the inert gas generator. Suitable fuel in sufficient quantity shall be provided for the inert gas generators.
- (B) The inert gas generators shall be located outside the cargo tank area. Spaces containing inert gas generators shall have no direct access to accommodation service or control station spaces, but may be located in machinery spaces. If they are not located in machinery spaces, such a compartment shall be separated by a gastight steel bulkhead and/or deck from accommodation, service and control station spaces. Adequate positive pressure type mechanical ventilation shall be provided for such a compartment.

(2) Gas regulating valves

- (A) A gas regulating valve shall be fitted in the inert gas main. This valve shall be automatically controlled to close, as required in 2 (8) (B). It shall also be capable of automatically regulating the flow of inert gas to the cargo tanks unless means are provided to automatically control the inert gas flow rate.
- (B) The gas regulating valve shall be located at the forward bulkhead of the forward most gas-safe space through which the inert gas main passes.

(3) Cooling and scrubbing arrangement

- (A) Means shall be fitted which will effectively cool the volume of gas specified in paragraphs 2

- (1) to 2(5) and remove solids and sulphur combustion products. The cooling water arrangements shall be such that an adequate supply of water will always be available without interfering with any essential services on the ship. Provision shall also be made for an alternative supply of cooling water.
- (B) Filters or equivalent devices shall be fitted to minimize the amount of water carried over to the inert gas blowers.
- (4) Blower
- (A) At least two blowers shall be fitted and be capable of delivering to the cargo tanks at least the volume of gas required by paragraphs 2(1) to 2(5). For systems with gas generators the Society may permit only one blower if that system is capable of delivering the total volume of gas required by paragraphs 2(1) to 2(5) to the protected cargo tanks, provided that sufficient spares for the blower and its prime mover are carried on board to enable any failure of the blower and its prime mover to be rectified by the ship's crew. The spare parts for blower and its prime mover means generally important component, and it is contained comprising a motor, starter and complete rotating element, including bearings of each type. The additional component may be required according to manufacture's recommendation and type of blower except above this. (2017)
- (B) Where inert gas generators are served by positive displacement blowers, a pressure relief device shall be provided to prevent excess pressure being developed on the discharge side of the blower.
- (C) When two blowers are provided, the total required capacity of the inert gas system shall be divided evenly between the two and in no case is one blower to have a capacity less than 1/3 of the total required.
- (5) For systems using flue gas, flue gas isolating valves shall be fitted in the inert gas mains between the boiler uptakes and the flue gas scrubber. These valves shall be provided with indicators to show whether they are open or shut, and precautions shall be taken to maintain them gastight and keep the seatings clear of soot. Arrangements shall be made to ensure that boiler soot blowers cannot be operated when the corresponding flue gas valve is open.
- (6) Prevention of flue gas leakage
- (A) Special consideration shall be given to the design and location of scrubber and blowers with relevant piping and fittings in order to prevent flue gas leakages into enclosed spaces.
- (B) To permit safe maintenance, an additional water seal or other effective means of preventing flue gas leakage shall be fitted between the flue gas isolating valves and scrubber or incorporated in the gas entry to the scrubber.
- (7) Indicators and alarms
- (A) In addition to the requirements in paragraph 2(1) to 2(5), means shall be provided for continuously indicating the temperature of the inert gas at the discharge side of the system, whenever it is operating.
- (B) In addition to the requirements of 2(11) (E), audible and visual alarms shall be provided to indicate:
- insufficient fuel oil supply to the oil-fired inert gas generator;
  - failure of the power supply to the generator;
  - low water pressure or low water flow rate to the cooling and scrubbing arrangement;
  - high water level in the cooling and scrubbing arrangement;
  - high gas temperature;
  - failure of the inert gas blowers; and
  - low water level in the water seal.

#### 4. Requirements for nitrogen generator systems

- The system shall be provided with one or more compressors to generate enough positive pressure to be capable of delivering the total volume of gas required by paragraph 2(1) to 2(5).
- A feed air treatment system is to be fitted to remove free water, particles and traces of oil from the compressed air, and to preserve the specification temperature.
- The following requirements are specific only to the gas generator system and apply where inert gas is produced by separating air into its component gases by passing compressed air through a bundle of hollow fibres, semi-permeable membranes or absorber materials.
- A nitrogen generator is to consist of a feed air treatment system and any number of membrane or absorber modules in parallel necessary to meet 2(4).
- The air compressor and nitrogen generator may be installed in the engine-room or in a separate compartment. A separate compartment and any installed equipment shall be treated as an "Other

- machinery space" with respect to fire protection. Where a separate compartment is provided for the nitrogen generator, the compartment shall be fitted with an independent mechanical extraction ventilation system providing 6 air changes per hour. The compartment is to have no direct access to accommodation spaces, service spaces and control stations.
- (6) The nitrogen generator is to be capable of delivering high purity nitrogen with O<sub>2</sub> content not exceeding 5% by volume. The system is to be fitted with automatic means to discharge "off-spec" gas to the atmosphere during start-up and abnormal operation.
  - (7) Where two compressors are provided, the total required capacity of the system is preferably to be divided equally between the two compressors, and in no case is one compressor to have a capacity less than 1/3 of the total capacity required. Only one air compressor may be accepted provided that sufficient spares for the air compressor and its prime mover are carried on board to enable their failure to be rectified by the ship's crew.
  - (8) Where a nitrogen receiver or a buffer tank is installed, it may be installed in a dedicated compartment, in a separate compartment containing the air compressor and the generator, in the engine room, or in the cargo area. Where the nitrogen receiver or a buffer tank is installed in an enclosed space, the access shall be arranged only from the open deck and the access door shall open outwards. Adequate, independent mechanical ventilation, of the extraction type, shall be provided for such a compartment.
  - (9) Indicators and alarms
    - (A) In addition to the requirements in 2(11)(B), instrumentation is to be provided for continuously indicating the temperature and pressure of air at the suction side of the nitrogen generator.
    - (B) In addition to the requirements in 2(11)(E), audible and visual alarms shall be provided to include:
      - (a) failure of the electric heater, if fitted;
      - (b) low feed-air pressure or flow from the compressor;
      - (c) high-air temperature; and
      - (d) high condensate level at automatic drain of water separator.
  - (10) The oxygen-enriched air from the nitrogen generator and the nitrogen-product enriched gas from the protective devices of the nitrogen receiver are to be discharged to a following safe location on the open deck.
    - (A) Oxygen-enriched air from the nitrogen generator:
      - (a) outside of hazardous area;
      - (b) not within 3m of areas traversed by personnel; and
      - (c) not within 6m of air intakes for machinery (engines and boilers) and all ventilation inlets.
    - (B) Nitrogen-product enriched gas from the protective devices of the nitrogen receiver:
      - (a) not within 3m of areas traversed by personnel; and
      - (b) not within 6m of air intakes for machinery (engines and boilers) and all ventilation inlet/outlet.
  - (11) In order to permit maintenance, means of isolation is to be fitted between the generator and the receiver.
5. Nitrogen/Inert gas systems fitted for purposes other than inerting required by **Ch.2 405.** of the Rules.
- (1) This section applies to systems fitted on oil tankers, gas tankers or chemical tankers to which **Ch.2 405.** of rules do not apply.
  - (2) 2 (8)(B) and 2 (8)(C), (B), (D) and 2 (11) (B), 2 (11) (C), 2 (11) (E) (a) (i), 2 (11) (E) (a) (ii), 2 (11) (E) (d) and 4 (1), (2), (5), (8) and (9) (A) & (B) as applicable apply to the systems.
  - (3) In case where nitrogen generator system is installed, the requirements of 4 apply except paragraphs (3), (4) and (7) of 4.
  - (4) Materials used in inert gas systems are to be suitable for their intended purpose in accordance with the Rules of the Classification Society.
  - (5) All the equipment is to be installed on board and tested under working conditions to the satisfaction of the Surveyor.
  - (6) The two non-return devices are to be fitted in the inert gas main. The non-return devices are to comply with 2(9)(B) and (C). however, where the connections to the cargo tanks, to the hold spaces or to cargo piping are not permanent, the non-return devices required by 2(9)(A) may be substituted by two non-return valves.
6. In case where glass-fibre reinforced plastic pipes are used for the drainage piping from the scrubber and blower fan casing, the following requirements are to be complied with:

- (1) The materials, design requirements, piping arrangements, connections of pipes, markings, tests and inspections are to be as specified in **Pt 5, Annex 5-6** of the Guidance.
- (2) In case where glass-fibre reinforced plastic pipes are provided inside the machinery space, the following requirements are to be complied with:
  - (A) A valve operable from both inside and outside the machinery space either by pneumatic or hydraulic pressure led through steel piping is to be provided on a distance piece fitted to the shell plating. This valve is to be of automatic closing type in case of failure of the operating system.
  - (B) The valve specified in (A) above is to be provided with an indicator showing the opening/closing condition.
  - (C) The valve specified in (A) above is to be closed at all time when the inert gas system is not in operation as well as in the event of a fire in the machinery space.
  - (D) For the valve specified in (A) above, a short piece of steel pipe or spool piece is to be fitted. Further, a swing type non-return valve is to be attached to the piece. The piece is to be provided with a drain pipe of an inside diameter of approximately 12.5 mm and a drain valve.
  - (E) On the inboard side of the non-return valve specified in (D) above, a short piece of steel pipe or spool piece provided with a drain pipe with an inside diameter of approximately 12.5 mm and a drain valve is to be fitted.
  - (F) The distance piece and valve specified in (A) above, and short piece of steel pipe or spool piece and swing type non-return valve specified in (D) and (E) above are to be of corrosion resisting materials or are to be protected internally by rubber, glass fibers, epoxy resins or equivalent coating materials.
  - (G) Means for stopping the scrubber pump is to be provided outside the machinery space.
7. Installation inspection of inert gas system shall be complied with the following requirements:
  - (1) After installation inboard, inert gas system is to be tested at the working condition in accordance with **Table Annex 8-5** as to airtight test and operation test, control device, safety system and warning device.
  - (2) The airtight test pressure for pipes and joints in the inert gas supply line is, in principle, to be 0.024 MPa. Note, however, that in case where the set pressure of the pressure/vacuum valve is 0.024 MPa or more, the test pressure is to be the set pressure of the pressure/vacuum valve.
  - (3) It is to be verified through the use of inert gas or fresh air that the capacity of the inert gas blower is equal to or greater than 1.25 times the maximum design discharge capacity of the ship. In case where fresh air is used in the test, such fresh air is to be taken in from the area in the proximity of the flue gas isolating valve. However, when a ship including its inert gas system is of the same design as a ship which has already tested, this test may be omitted.

Table Annex 8-5 effectiveness test item

Item	Audible and visual alarm	Safety device	Note
(1) Supplied water pressure of scrubber and discharge drop	○	Inert gas control valve closing Inert gas blower stop	
(2) A rising of the water level in the scrubber	○	Inert gas control valve closing Inert gas blower stop Stop of cooling water supply pump for scrubber	
(3) Inert gas high temperature of an outlet of inert gas blower	○	Inert gas control valve closing Inert gas blower stop	
(4) An obstacle of inert gas blower	○	Inert gas control valve closing	
(5) Oxygen content of inert gas blower outlet in excess of 8 % by volume	○	-	Closing passively to non-return device in addition to improvement of gas quality and water seal Alarm is to be given to machinery room and cargo control room
(6) Failure of the power supply to the automatic control system for the inert gas regulation valve	○	-	Alarm is to be given to machinery room and cargo control room
(7) Failure of the power the pressure of the inert gas supply mains aftward of the non-return device	○		
(8) Failure of the power supply to the oxygen content of the inert gas blower outlet	○		
(9) Low water level in the water seal	○	-	-
(10) Gas pressure less than 100 mm water gauge forward of non-return device	○	-	Alarm to machinery room and cargo control room
(11) Overpressure in inert gas supply main forward of non-return device	○	-	-
(12) Supply stop of inert gas	○	-	Low water level alarm is to be operated in the water seal Watertight is to be formed in the water seal
(13) Predetermined limits of low pressure in the inert gas mains being reached	○	-	Automation stop of cargo oil pump should be available
(14) The automatic control system for the inert gas regulation valve	-	-	Provided where the automatic control system for the inert gas blower are not be provided
(15) Indicating device, recording device, measuring device	-	-	Operation and effectiveness test are to be accomplished

## Annex 8-6 Other Operation Requirements, etc. [See Rule]

1. At all times while the ship is in service, the requirements that fire protection systems and fire-fighting systems and appliances are to be maintained ready for use shall be complied with. A ship is not in service when:
  - (1) it is in for repairs or lay-up (either at anchor or in port) or in dry-dock;
  - (2) it is declared not in service by the owner or the owner's representative; and
  - (3) in the case of passenger ships, there are no passengers on board.
2. The following fire protection systems shall be kept in good order so as to ensure their required performance if a fire occurs:
  - (1) structural fire protection including fire resisting divisions, and protection of openings and penetrations in these divisions;
  - (2) fire detection and fire alarm systems; and
  - (3) means of escape systems and appliances.
3. Fire-fighting systems and appliances shall be kept in good working order and readily available for immediate use. Portable extinguishers which have been discharged shall be immediately recharged or replaced with an equivalent unit.
4. Maintenance, testing and inspections shall be carried out based on the guidelines developed by the IMO Organization and in a manner having due regard to ensuring the reliability of fire-fighting systems and appliances.
5. The maintenance plan shall be kept on board the ship and shall be available for inspection whenever required by the Society.
6. The maintenance plan shall include at least the following fire protection systems and fire-fighting systems and appliances, where installed:
  - (1) fire mains, fire pumps and hydrants including hoses, nozzles and international shore connections;
  - (2) fixed fire detection and fire alarm systems;
  - (3) fixed fire-extinguishing systems and other fire extinguishing appliances;
  - (4) automatic sprinkler, fire detection and fire alarm systems;
  - (5) ventilation systems including fire and smoke dampers, fans and their controls;
  - (6) emergency shut down of fuel supply;
  - (7) fire doors including their controls;
  - (8) general emergency alarm systems;
  - (9) emergency escape breathing devices;
  - (10) portable fire extinguishers including space charges; and
  - (11) fire-fighter's outfits.
7. The maintenance programme may be computer-based.
8. In addition to the fire protection systems and appliances listed in paragraph **102. 3** ships carrying more than 36 passengers shall develop a maintenance plan for low-location lighting and public address systems.
9. In addition to the fire protection systems and appliances listed in paragraph **102. 3** tankers shall develop a maintenance plan for:
  - (1) inert gas systems;
  - (2) deck foam systems;
  - (3) fire safety arrangements in cargo pump rooms; and
  - (4) flammable gas detectors.
10. A training manual shall be provided in each crew mess room and recreation room or in each crew cabin.
11. The training manual shall be written in the working language of the ship.
12. The training manual, which may comprise several volumes, shall contain the instructions and information required in paragraph **4** in easily understood terms and illustrated wherever possible. Any part of such information may be provided in the form of audio-visual aides in lieu of the manual.
13. The training manual shall explain the following in detail:
  - (1) general fire safety practice and precautions related to the dangers of smoking, electrical hazards, flammable liquids and similar common shipboard hazards;

- (2) general instructions on fire-fighting activities and fire-fighting procedures including procedures for notification of a fire and use of manually operated call points;
  - (3) meanings of the ship's alarms;
  - (4) operation and use of fire-fighting systems and appliances;
  - (5) operation and use of fire doors;
  - (6) operation and use of fire and smoke dampers; and
  - (7) escape systems
14. Fire Control Plans shall be permanently exhibited for the guidance of the ship's officers. Alternatively, at the discretion of the Society, the aforementioned details may be set out in a booklet, a copy of which shall be supplied to each officer, and one copy shall at all times be available on board in an accessible position. Plans and booklets shall be kept up to date; any alterations thereto shall be recorded as soon as practicable. Description in such plans and booklets shall be in the language or languages required by the Society. If the language is neither English nor French, a translation into one of those languages shall be included.
15. A duplicate set of fire control plans or a booklet containing such plans shall be permanently stored in a prominently marked weathertight enclosure outside the deckhouse for the assistance of shore-side fire-fighting personnel.
16. In ships carrying more than 36 passengers, plans and booklets required by this regulation shall provide information regarding fire protection, fire detection and fire extinction based on the guidelines issued by the IMO Organization.
17. The required fire safety operational booklet shall contain the necessary information and instructions for the safe operation of the ship and cargo handling operations in relation to fire safety. The booklet shall include information concerning the crew's responsibilities for the general fire safety of the ship while loading and discharging cargo and while underway. Necessary fire safety precautions for handling general cargoes shall be explained. For ships carrying dangerous goods and flammable bulk cargoes, the fire safety operational booklet shall also provide reference to the pertinent fire-fighting and emergency cargo handling instructions contained in the International Maritime Solid Bulk Cargoes Code, the International Bulk Chemical Code, the International Gas Carrier Code and the International Maritime Dangerous Goods Code, as appropriate.
18. The fire safety operational booklet shall be provided in each crew mess room and recreation room or in each crew cabin.
19. The fire safety operational booklet shall be written in the working language of the ship.
20. The fire safety operational booklet may be combined with the training manuals.
21. **Additional requirements for tankers (2020)**
- (1) The fire safety operational booklet referred to in 17 shall include provisions for preventing fire spread to the cargo area due to ignition of flammable vapours and include procedures of cargo tank gas-purging and/or gas-freeing taking into account the provisions as follows, Procedures for cargo tank purging and/or gas-freeing
  - (2) Procedures for cargo tank purging and/or gas-freeing
    - (A) When the ship is provided with an inert gas system, the cargo tanks shall first be purged in accordance with **Ch 2, 406.** of the Rules until the concentration of hydrocarbon vapours in the cargo tanks has been reduced to less than 2 % by volume. Thereafter, gas-freeing may take place at the cargo tank deck level.
    - (B) When the ship is not provided with an inert gas system, the operation shall be such that the flammable vapour is discharged initially through:
      - (a) the vent outlets as specified in **Ch 2, 403. 4** of the Rules;
      - (b) outlets at least 2 m above the cargo tank deck level with a vertical efflux velocity of at least 30 m/s maintained during the gas-freeing operation; or
      - (c) outlets at least 2 m above the cargo tank deck level with a vertical efflux velocity of at least 20 m/s and which are protected by suitable devices to prevent the passage of flame.
    - (C) The above outlets shall be located not less than 10 m measured horizontally from the nearest air intakes and openings to enclosed spaces containing a source of ignition and from deck machinery, which may include anchor windlass and chain locker openings, and equipment which may constitute an ignition hazard.
    - (D) When the flammable vapour concentration at the outlet has been reduced to 30% of the

- lower flammable limit, gas-freeing may be continued at cargo tank deck level.
- (3) Operation of inert gas system
- (A) The inert gas system for tankers required in accordance with **Ch 2, 405. 1** of the Rules shall be so operated as to render and maintain the atmosphere of the cargo tanks non-flammable, except when such tanks are required to be gas-free.
  - (B) Notwithstanding the above, for chemical tankers, the application of inert gas, may take place after the cargo tank has been loaded, but before commencement of unloading and shall continue to be applied until that cargo tank has been purged of all flammable vapours before gas-freeing. Only nitrogen is acceptable as inert gas under this provision.
  - (C) If the oxygen content of the inert gas exceeds 5% by volume, immediate action shall be taken to improve the gas quality. Unless the quality of the gas improves, all operations in those cargo tanks to which inert gas is being supplied shall be suspended so as to avoid air being drawn into the cargo tanks, the gas regulating valve, if fitted, shall be closed and the off-specification gas shall be vented to atmosphere.
  - (D) In the event that the inert gas system is unable to meet the requirement in (A) and it has been assessed that it is impractical to effect a repair, then cargo discharge and cleaning of those cargo tanks requiring inerting shall only be resumed when suitable emergency procedures have been followed, taking into account guidelines developed by IMO (MSC/Circ.353, MSC/Circ.387 and MSC/Circ.485).
  - (E) When a product containing an oxygen-dependent inhibitor is carried on a ship for which inerting is required, the inert gas system shall be operated as required to maintain the oxygen level in the vapour space of the tank at or above the minimum level of oxygen required under paragraph 15.13 of the IBC Code and as specified in the Certificate of Protection (MSC.1/Circ.1501).



## Annex 8-7 Safe Return to Port System on Passenger Ships

[See Rule]

1. The scope is to be as specified in the followings.  
New passenger ships including those having of 120 m or more or having three or more main vertical zones.
2. The objectives are to be as specified in the followings.
  - (1) For ships having at least two independent means of propulsion and steering to comply with SOLAS requirements for a safe return to port, the following requirements are applicable.
    - (A) Provide knowledge of the effects of failure in all the equipment and systems due to fire in any space, or flooding of any watertight compartment that could affect the availability of the propulsion and steering.
    - (B) Provide solutions to ensure the availability of propulsion and steering upon such failures in item (a).
  - (2) Ships not required to satisfy the safe return to port concept will require the analysis of failure in single equipment and fire in any space to provide knowledge and possible solutions for enhancing availability of propulsion and steering.
3. Casualty threshold
  - (1) The casualty threshold, in the context of a fire, includes:
    - (A) Loss of space of origin up to the nearest "A" class boundaries, which may be a part of the space of origin, if the space of origin is protected by a fixed fire extinguishing system; or
    - (B) Loss of the space of origin and adjacent spaces up to the nearest "A" class boundaries, which are not part of the space of origin.
  - (2) The casualty threshold, in the context of a flooding, includes:
    - (A) The casualty threshold for flooding casualties is the loss of any single watertight compartment.
    - (B) Flooding not exceeding the casualty threshold described in (A), the systems specified in **4** remain operational.
4. Safe return to port
  - (1) When fire damage does not exceed the casualty threshold indicated in paragraph 3, the ship shall be capable of returning to port while providing a safe area as defined in regulation 3. To be deemed capable of returning to port, the following systems shall remain operational in the remaining part of the ship not affected by fire:
    - (A) Propulsion
    - (B) Steering systems and steering-control systems
    - (C) Navigational systems
    - (D) Systems for fill, transfer and service of fuel oil
    - (E) Internal communication between the bridge, engineering spaces, safety centre, fire-fighting and damage control teams, and as required for passenger and crew notification and mustering
    - (F) External communication
    - (G) Fire main system
    - (H) Fixed fire-extinguishing systems
    - (I) Fire and smoke detection system
    - (J) Bilge and ballast system
    - (K) Power-operated watertight and semi-watertight doors
    - (L) Systems intended to support "safe areas" as indicated in **5**
    - (M) Flooding detection systems
    - (N) Other systems determined by the Administration to be vital to damage control efforts
  - (2) If the casualty threshold indicated in paragraph 3 is exceeded, Design criteria for systems are to be required to remain operational for supporting the orderly evacuation and abandonment of a ship.
    - (A) In case any one main vertical zone is unserviceable due to fire, the following systems shall be so arranged and segregated as to remain operational.
      - (a) Fire main
      - (b) Internal communications (in support of fire-fighting as required for passenger and crew

- notification and evacuation)
  - (c) Means of external communications
  - (d) Bilge systems for removal of fire-fighting water
  - (e) Lighting along escape routes, at assembly stations and at embarkation stations of life-saving appliances
  - (f) Guidance systems for evacuation shall be available
- (B) The above systems shall be capable of operation for at least 3 h based on the assumption of no damage outside the unserviceable main vertical zone. These systems are not required to remain operational within the unserviceable main vertical zones.
- (C) Cabling and piping within a trunk constructed to an "A-60" standard shall be deemed to remain intact and serviceable while passing through the unserviceable main vertical zone for the purposes of paragraph 3.1. An equivalent degree of protection for cabling and piping may be approved by the Administration.
5. Safe area(s)
- (1) The safe area(s) shall generally be internal space(s), however, the use of an external space as a safe area may be allowed by the Administration taking into account any restriction due to the area of operation and relevant expected environmental conditions.
  - (2) The safe area(s) shall provide all occupants with the following basic services\* to ensure that the health of passengers and crew is maintained:
    - (A) Sanitation
    - (B) Water
    - (C) Food
    - (D) Alternate space for medical care
    - (E) Shelter from the weather
    - (F) Means of preventing heat stress and hypothermia
    - (G) Light
    - (H) Ventilation
  - (3) Ventilation design shall reduce the risk that smoke and hot gases could affect the use of the safe area(s)
  - (4) Means of access to life-saving appliances shall be provided from each area identified or used as a safe area, taking into account that a main vertical zone may not be available for internal transit.
  - (5) Alternate space for medical care shall conform to a standard acceptable to the Administration.
6. Safety centre on passenger ships
- (1) This is to provide a space to assist with the management of emergency situations.
  - (2) The safety centre shall either be a part of the navigation bridge or be located in a separate space adjacent to and having direct access to the navigation bridge, so that the management of emergencies can be performed without distracting watch officers from their navigational duties. The layout and ergonomic design of the safety centre shall take into account the guidelines developed by the Organization, as appropriate.
  - (3) Means of communication between the safety centre, the central control station, the navigation bridge, the engine control room, the storage room(s) for fire extinguishing system(s) and fire equipment lockers shall be provided.
  - (4) Means of communication between the safety centre, the central control station, the navigation bridge, the engine control room, the storage room(s) for fire extinguishing system(s) and fire equipment lockers shall be provided.
    - (A) All powered ventilation systems
    - (B) Fire doors
    - (C) General emergency alarm system
    - (D) Public address system
    - (E) Electrically powered evacuation guidance systems
    - (F) Watertight and semi-watertight doors
    - (G) Indicators for shell doors, loading doors and other closing appliances
    - (H) Water leakage of inner/outer bow doors, stern doors and any other shell door
    - (I) Television surveillance system
    - (J) Fire detection and alarm system
    - (K) Fixed fire-fighting local application system(s)
    - (L) Sprinkler and equivalent systems

- (M) Water-based systems for machinery spaces
  - (N) Alarm to summon the crew
  - (O) Atrium smoke extraction system
  - (P) Flooding detection systems
  - (Q) Fire pumps and emergency fire pumps
7. For the assessment of passenger ship systems' capabilities after a fire or flooding casualty is in accordance with the requirements of **IMO MSC.1/Circ.1369** and **MSC.1/Circ.1369/Add.1**. (2018)

## Annex 8-8 Qualitative Failure Analysis for Propulsion and Steering on Passenger Ships – *⟨Void⟩ (2023)*

## Annex 8-9 Special Requirements of Fire Protection and Fire Extinction for Cargo Ships (2021)

### Section 1 General Requirements

#### 101. Application

The AFP(Additional Fire Protection and fire extinction) notations as additional special features are given to the cargo ships complying with the requirements of this annex, and the details are as follows. In addition, requirements of **SOLAS Convention**, **FSS Code** and the **Flag Administration** are also to be complied with. (2022)

- (1) AFP-A: Ships whose accommodation spaces comply with the requirement of **Sec 2**.
- (2) AFP-M: Ships whose machinery spaces comply with the requirement of **Sec 3**.
- (3) AFP-C: Ships whose cargo spaces comply with to the related requirement of **Section 4**.
  - (A) In case the container ships, the class notation of the below may be assigned to ships which have been constructed to comply with the related requirements.
    - (a) AFP-C(1): Container ships whose cargo spaces comply with the requirements specified in **405. 2**
    - (b) AFP-C(2): Container ships whose cargo spaces comply with the requirements specified in **405. 3**
    - (c) AFP-C(3): Container ships whose cargo spaces comply with the requirements specified in **405. 4**
    - (d) AFP-C(FSC): Container ships whose cargo spaces comply with the requirements specified in **405. 5**
  - (B) In case the ro-ro ships and vehicle carriers, the class notation as following may be assigned to ships which have been constructed to comply with the related requirements. (2022)
    - (a) AFP-C: Ro-ro ships and vehicle carriers whose cargo spaces comply with the requirements specified in **402. 2**
    - (b) AFP-C(EV): PCC notation assigned pure car carriers or pure car/truck carriers whose cargo spaces comply with the requirements specified in **402. 3** (2024)
- (4) Requirements of **Section 2**, **Section 3** and **Section 4** can be combined and applied. In case the cargo ship which complies with **Section 2** and **Section 3** is given a notation "AFP-AM" as addition special feature notation.

### Section 2 Protection of Accommodation Spaces

#### 201. Application

1. This section is applicable to the cargo ships which apply to the notation AFP-A.

#### 202. Fire growth probability

##### 1. Furniture in stairway enclosures

- (1) Furniture in stairway enclosures is to be limited to seating. It is to be fixed, limited to six seats on each deck in each stairway enclosure, be of restricted fire risk determined in accordance with the FTP Code, and is not to restrict the passenger escape route.
- (2) Furniture is not to be permitted in corridors forming escape routes in cabin areas. In addition to the above, lockers of non-combustible material, providing storage for non-hazardous safety equipment required by these regulations, may be permitted.

#### 203. Fixed fire detection and fire alarm system

A individually identifiable fixed fire detection and fire alarm system is to be installed and arranged as to provide smoke detection in service spaces, control stations and accommodation spaces, including corri-

dors, stairways and escape routes within accommodation spaces. Heat detectors in lieu of smoke detectors may be installed in galleys and refrigerated chambers. Spaces having little or no fire risk such as voids, public toilets, private bathrooms, carbon dioxide rooms and similar spaces need not be fitted with a fixed fire detection and alarm system. Detectors fitted in cabins, when activated, are also to be capable of emitting, or cause to be emitted, an audible alarm within the space where they are located.

## 204. Containment of Fire

### 1. Method of protection in accommodation

The IC method specified in **Ch 7, 103. 1** of the Rules is to be adopted in accommodation, service spaces and control places.

### 2. Bulkheads

- (1) All compartment bulkheads, linings, and ceilings in accommodation, service spaces and control stations are to be at least “B-15” class. Private sanitary units are considered as part of the cabin where they are located, and the bulkheads and doors inside the cabin may be reduced to “C” class divisions.
- (2) Corridors in accommodation areas are to be divided by “B-15” class self-closing doors every 20m of the maximum distance. For corridors which transverse corridors and longitudinal corridors are connected to each other, “B-15” class self-closing doors are to be installed if the total length exceeds 20m.

### 3. Fire integrity of bulkheads and decks

- (1) All decks in accommodation, including corridors, and service spaces, are to be at least “A-0” class.
- (2) All bulkheads and decks separating the accommodation spaces from the machinery spaces, cargo holds, ballast pump room and cargo pump room are to have “A-60” class. This requirement does not apply to service spaces such as air-conditioning rooms and service trunks and only serving accommodation and other machinery spaces specified in ⑦ of **Ch 7, 103. 3 (2) (B)** of the Rules located within the accommodation area.
- (3) All doors fitted in the corridor bulkheads in cabins and public spaces are to be of self-closing type. Normally locked doors need not to comply with this requirement.

## 205. Means of escape

1. A corridor, lobby, or part of a corridor from which there is only one route of escape is to be prohibited. Dead-end corridors used in service areas which are necessary for the practical utility of the ship, such as fuel oil stations and athwartship supply corridors, are to be permitted, provided such dead-end corridors are separated from accommodation areas. Also, a part of a corridor that has a depth not exceeding its width is considered a recess or local extension and is permitted.
2. Spaces exceeding 30m<sup>2</sup> are to be provided with at least two widely separated means of escape. Such means of escape are to be a door having direct access to a corridor, a stairway or an open deck.

## Section 3 Protection of Machinery Spaces

### 301. Application

1. This section is applicable to the cargo ships which apply to the notation AFP-M.

### 302. Possibility of ignition

#### 1. Measures for fuel oil

Oil fired thermal oil heaters and incinerators are subject to the same segregation requirements as fuel oil purifiers. They are to be arranged in a separate room, enclosed by steel bulkheads extending from deck to deck and provided with self-closing steel doors.

## 2. Hydraulic system

The hydraulic system of **Pt 5, Ch 6, Sec 13** of the Rules is to be located outside the main engine or boiler room.

### 303. Fire detection and fire alarm systems

#### 1. Fire detection systems

- (1) All machinery spaces, including auxiliary machinery spaces, are to be equipped with fire detection systems.
- (2) Two or more types of fire detection systems are to be installed to protect the machinery spaces of category A. Smoke detectors and flame detectors are to be installed in the vicinity of engines, fuel oil purifiers, oil boilers and similar equipment.
- (3) Smoke detectors located in the workshop should be connected to a timer function that resets automatically after a maximum of 30 minutes.

#### 2. TV monitoring systems

- (1) Machinery spaces of category A are to be equipped with color TV monitoring systems to monitor all hot spots of all major equipment such as engines having rated output above 375kW, heated oil separators, oil boilers and emergency diesel engines when it is used in ports. TV monitoring systems are to be located in a continuously manned control station or engine control room.

### 304. Containment of fire

1. In machinery spaces of category A, at least one exhaust ventilation fan is to be powered from an emergency power source so as to permit the discharge of smoke and gas extinguishing agents (if used) after a fire.

### 305. Local application system

1. The local application system is to be capable of automatic release.
2. The operation of the system is to be controlled by a combination of flame and smoke detectors. The detection system is to provide an alarm upon activation of any single detector and the fire extinguishing system is to be operated when two or more detectors are activated. The zones in which detection systems are fitted are to correspond to the zones of extinguishing system.

### 306. Central Control Station

1. The controls required by the following requirements are to be located in the central control station. It is to have safe access from the open deck.
  - (1) **Ch 3, 102. 1 to 4** of the Rules
  - (2) **Ch 6, 201.** of the Rules
  - (3) **Ch 7 204. 1** of the Rules
  - (4) Controls for any required fire extinguishing systems and TV monitoring systems.
2. However, controls for activation of the fixed fire extinguishing system in machinery spaces of category A and controls for closing the fuel oil valve are to be easily accessible but may be installed outside the central control station.

### 307. Escape

1. Two means of escape are to be provided from the machinery control rooms located within the machinery space, at least one of which is to be continuous fire shelter to a safe location outside the machinery spaces. This is also applicable to the workshops and, where possible, to auxiliary machinery spaces.

## Section 4 Protection of Cargo areas

### 401. Bulk Carrier

#### 1. Application

This article is applicable to the bulk carriers which apply to the notation AFP-C.

#### 2. fire detection and fire alarm system

All cargo holds are to be fitted with either a fixed fire detection and fire alarm system complying with the requirements of **Ch 9** of the FSS Code or a sample extraction smoke detection system complying with the requirements of **Ch 10** of the FSS Code.

#### 3. fire fighting

- (1) Cargo spaces are to be provided with a fixed carbon dioxide or inert gas fire-extinguishing system complying with the provisions of the FSS Code or with a fire-extinguishing system which, in the opinion of the Society, gives equivalent protection for the cargoes carried.
- (2) The exemption requirement as referred in **Ch 8, 601. 4** of the Rules do not apply to ships intended for the additional notation AFP-C.

### 402. Ro-ro ship and vehicle carrier (2022)

#### 1. Application

This article is applicable to the ro-ro ship and vehicle carrier which apply to the following notations.

- (1) AFP-C: Ships whose cargo spaces comply with the requirements specified in **402. 2**
- (2) AFP-C(EV): PCC notation assigned pure car carriers or pure car/truck carriers whose cargo spaces comply with the requirements specified in **402. 3 (2024)**

#### 2. AFP-C

The fixed fire detection and fire alarm systems for all ro-ro spaces and vehicle spaces are to be capable of individually identifying each detector.

#### 3. AFP-C(EV) (2022)

The following requirements are to be satisfied for ro-ro spaces and vehicle spaces intended for the carriage of battery-powered electric vehicles and a plan for fighting its fire is to be available on board.

- (1) Fire detection and fire alarm system
  - (A) Combined type smoke and heat detectors and fire alarms are to be arranged and installed for all ro-ro spaces and vehicle spaces.
  - (B) Cameras (CCTV) are to be installed that can monitor the ro-ro spaces and vehicle spaces intended for the carriage of battery-powered electric vehicles. Colour video monitoring is to be available at the navigation bridge or the fire control station.
  - (C) At least two explosion-proof portable thermal imaging cameras are to be provided on board to measure the temperature of the ro-ro spaces and the vehicle spaces periodically.
- (2) Fixed fire extinguishing arrangement

Where the fixed CO<sub>2</sub> fire extinguishing system is fitted for ro-ro spaces and vehicle spaces, a connection such as spool piece or flexible hose that connects the fire main system and the CO<sub>2</sub> discharge piping is to be provided to supply water to the CO<sub>2</sub> discharge nozzles. The purpose of this arrangement is to provide an auxiliary means to cool down the ro-ro spaces and vehicle spaces by supplying water to the CO<sub>2</sub> discharge nozzles, in case the total amount of CO<sub>2</sub> extinguishing agent is discharged in the event of fire or the CO<sub>2</sub> fire extinguishing system fails to operate.
- (4) Fire fighting equipment
  - (A) In addition to the fire-fighter's outfits required by **SOLAS Reg. Ch. II-2**, at least two sets of fire-fighter's outfits are to be provided in an easily accessible location adjacent to the designated area for the carriage of battery-powered electric vehicles.



- (B) At least one water mist lance together with at least one fire blanket shall be provided at each cargo space where capable of being sealed and carrying battery-powered electric vehicles.
- (5) Recommendations for the safe operation of battery-powered electric vehicle charging  
In case an electric vehicle charging facility is installed on board, charging of electric vehicles is available only when safety is presented while vehicles are being unloaded. The following items are to be considered:
- (A) Available charging per unit shall in general be provided with low/medium power (up to 5 kW).
- (B) Power supply circuits serving such units shall be monitored for short circuit/ground fault with alarm to a continuously manned control station. Means to isolate these circuits shall be readily accessible for the crew and clearly marked.
- (C) A manual for the safe operation of the charging facility shall be available on board. The connection of chargers shall be monitored by the crew.
- (D) Charging shall be in an area where the impact from a fire in other units is minimized and impact from a fire starting in charges or electrical vehicle being charged is minimized. Charging of electric vehicles is available only when safety is presented while vehicles are being unloaded. Safety procedures such as sufficient ventilation while charging and limitation of the State of Charge (SOC) of the battery, etc. are to be complied with in order to minimize fire risk.

### 403. Tanker

#### 1. Application

This article is applicable to the tanker and chemical tanker which apply to the notation AFP-C.

#### 2. Inert gas system

An inert gas system complying with **Annex 8-5** is to be provided for all tankers. However, this is not applicable for tankers engaged in the carriage of oil with flashpoint above 60°C.

#### 3. fire detection and fire alarm system

- (1) A fixed fire detection and fire alarm system is to be of an approved type and complying with the requirements of **Ch 9** of the FSS Code.
- (2) Repeater panel is to be located in the wheelhouse.

#### 4. fire main and hydrants

- (1) The fire main on deck is to be arranged as a ring main laid to the port and starboard side.
- (2) Isolation valves are to be globe valves of steel or fire safe butterfly valves.
- (3) Main fire pumps are to be remote-controlled from the wheelhouse.

#### 5. water spray system

- (1) If lifeboats are not separated from cargo spaces by steel bulkheads, a manual water spraying system covering with a uniformly distributed water application rate of at least 10 l/min/m<sup>2</sup> over the sides and top of each lifeboat is to be provided. It may be taken from the fire main with the isolating valve located outside the protected area.
- (2) If the capacity of the fire pumps is sufficient for simultaneous activation of the water spraying system and the fire main system. The system is to be remote-controlled from the wheelhouse.

#### 6. foam system

- (1) For oil tankers of less than 8,000 tonnes deadweight, foam from the fixed foam system is to be supplied by means of monitors and foam applicators.
- (2) Tankers of 8,000 tonnes deadweight and upwards need an independent foam main, arranged along the centre line as a single line with foam outlet branches to both port and starboard arranged just aft of each monitor. At least two foam mixing units and two foam concentrate pumps are to be provided, placed together with the storage tank for foam concentrate in a dedicated room. Foam concentrate sufficient for 30 minutes of continuous foam production are to be stored onboard. Two foam monitors at each side of the accommodation front and monitors covering the cargo manifold are to be remote-controlled from the bridge or from another safe area with a good visibility to the monitors coverage area.

#### 404. Liquefied gas carriers

##### 1. Application

This article is applicable to the tanker and chemical tanker which apply to the notation AFP-C.

##### 2. fire main and hydrants

- (1) The fire main on deck is to be arranged as a ring main laid to the port and starboard side.
- (2) Isolation valves are to be globe valves of steel or fire safe butterfly valves.
- (3) Main fire pumps are to be remote-controlled from the wheelhouse.

##### 3. water spray system

- (1) If lifeboats are not separated from cargo spaces by steel bulkheads, a manual water spraying system covering with a uniformly distributed water application rate of at least 10 l/min/m<sup>2</sup> over the sides and top of each lifeboat is to be provided. It may be taken from the fire main with the isolating valve located outside the protected area.
- (2) If the capacity of the fire pumps is sufficient for simultaneous activation of the water spraying system and the fire main system. The system is to be remote-controlled from the wheelhouse.

##### 4. dry chemical powder fire extinguishing system

Dry chemical powder fire-extinguishing systems is to be installed in accordance with **Pt7, Ch 5, 1104. 2** of the Rules. The dry powder quantity is to be stored on board to provide a minimum of 60 seconds operation.

##### 5. fire detection and fire alarm system

- (1) All cargo holds are to be fitted with a fixed fire detection and fire alarm system is to be of an approved type complying with the requirements of **Ch 9** of the FSS Code and so installed and arranged as to provide smoke detection in enclosed spaces such as cargo pump room, compressor room, reliquefaction room, regasification spaces, and electric motor room within the cargo area.
- (2) Repeater panel is to be located in the wheelhouse.

##### 6. fixed gas fire-extinguishing system

- (1) Enclosed spaces containing cargo handling equipment, such as compressor and pump rooms, reliquefaction room, regasification spaces, and electric motor room within the cargo area are to be provided with the one of following;
  - (A) a fixed gas fire-extinguishing system complying with the requirements of **Ch 5** of FSS Code, taking into account the necessary concentrations required for extinguishing gas fires; or
  - (B) a water mist fire-extinguishing system complying with the requirements of **Ch 7** of FSS Code.
- (2) A fixed fire-extinguishing system at the vent outlet is to be provided inside venting masts for cargo tank venting system by nitrogen, CO<sub>2</sub> or other suitable medium.

#### 405. Container ships

##### 1. Application

This article is applicable to the container ships which apply to the following notations.

- (1) AFP-C(1): Container ships whose cargo spaces comply with the requirement of **405. 2**
- (2) AFP-C(2): Container ships whose cargo spaces comply with the requirement of **405. 3**
- (3) AFP-C(3): Container ships whose cargo spaces comply with the requirement of **405. 4**
- (4) AFP-C(FSC): Container ships whose cargo spaces comply with the requirement of **405. 5**

##### 2. AFC-C(1)

- (1) Water mist lances which comply with **Ch 8, 603. 1** of the **Rules** are to be provided.
- (2) Mobile water monitors
 

In addition to the water mist lance, the ship is to be provided with mobile water monitors, capable to reach the highest level of containers or the 5th tier of containers above the upper lashing bridge, whichever is the lowest.
- (3) Fire-fighter's outfits

- (A) Ships shall carry at least six(6) fire-fighter's outfits.
  - (B) Two spare charges shall be provided for each required breathing apparatus.
  - (C) At least two breathing air compressors are to be supplied from the main and emergency switchboard, or independently driven, complete with all fittings necessary for recharging the cylinders of air breathing apparatuses. The compressors are to be located in at least two sheltered and widely separated positions.
- (4) Device for fire patrols  
A portable thermal imaging camera is to be provided. In case of the device to be used in hazardous area, it shall be of a certified type.

### 3. AFC-C(2)

In addition to the requirements of **2**, ships assigned with the notation AFC-C(2) are to comply with this article.

(1) Central control station

The control and monitoring functions of fire safety system should be concentrated which is continuously manned central control station. The following functions are to be provided at the central control station and may be the wheelhouse or a dedicated fire control station continuously manned by a responsible member of the crew.

- (A) Audible and visual alarms upon activation of the container hold fire detection system
- (B) Indicators to identify the container hold where fire, heat and/or smoke have been detected.
- (C) Devices for the crew to manually operate the fire extinguishing system serving the container holds.
- (D) Shut-down for all mechanical ventilation systems of container hold
- (E) Display and alarm systems for ventilation system
- (F) Other functions considered necessary for safety

(2) A fixed fire detection and fire alarm system

Under deck cargo holds are to be fitted with either a fixed fire detection and fire alarm system or a sample extraction smoke detection system required is to be complied with the FSS Code.

(3) Fire main

(A) The fire main is to be arranged as a ring main laid to the port and starboard side with isolation valves installed at regular intervals. As a minimum it is to be possible to isolate the following sections from the rest of the fire main:

- (a) Sections of the fire main serving accommodation, machinery, service spaces and control stations located in each superstructure block or in the forecastle
- (b) Sections of the fire main serving cargo holds and cargo stowage areas on deck located aft of superstructure blocks, between two superstructure blocks or forward of the superstructure blocks.

(B) Isolation valves are to be steel globe valves or fire safe butterfly valves.

(C) Arrangements are to be made to ensure immediate availability of a supply of water from the fire main at the required pressure either by permanent pressurization or by suitably placed remote arrangements for the fire pumps.

(D) The quantity of water delivered is to be capable of supplying four nozzles of a size and at pressures as specified in **Ch 8, 101. 6** of the **Rules** and **Ch 8, 103. 3** of the **Rules**.

(E) The arrangement of the hydrants and fire hoses is to be such that it is possible to reach any part of the cargo holds and stowage areas on deck when empty with two jets of water not emanating from the same hydrant, one of which is to be from a single length of hose.

(F) The capacity of the fire pump and fire main diameter are to be sufficient for the simultaneous use of the following combinations of systems, whichever is the most demanding:

- (a) Combination of fire main four nozzles as required by (E), water-spray system below hatch cover, one water monitor as required by (4) and superstructure block protection water-spray
- (b) Combination of fire main four nozzles as required by (E), mobile water monitors required by **2 (1)** or **Ch 8, 603. 2** of the **Rules**

(4) Fixed water monitors covering the ondeck cargo area

(A) The arrangement, height and length of throw of the monitors is to be such that any point on the top of the container stacks can be reached by the water jet from one monitor, taking into account the maximum height of the container stacks.

(B) The capacity of the pump and arrangement of the piping system supplying water to the water monitors is to be sufficient to achieve the full throw of any one monitor. The system

- may be fed by the fire pumps provided their capacity is in accordance with (3) (F).
- (C) Water supply to the system is to comply with one of the following.
    - (a) The system is to be supplied by the fire pumps and compliance with (3) (F) is to be ensured; or
    - (b) The system is to be supplied by dedicated pumps and as a backup the main supply line of the system is to be connected to the fire main through a stop valve located as far as possible from the container cargo holds and cargo area on deck; or
    - (c) The system is to be provided with a redundant means of pumping. The capacity of the redundant means is to be sufficient to compensate for the loss of any single supply pump. Failure of any one component in the power and control system should not result in a reduction of required pump capacity by more than 50%. Switch over to redundant means of pumping may be manual or automatic.
  - (D) Pump and monitor controls are to be available at a single position.
  - (E) Water monitors are to be of an approved type and are to be capable of supplying a continuous full water jet without significant pulsations and compacted in such a way as to be concentrated on a limited surface. Monitors are to be of robust construction and capable of withstanding the reaction forces of the water jet.
  - (F) Scuppers are to be fitted so as to ensure that the water is rapidly discharged overboard. Means are to be provided to prevent the blockage of drainage arrangements and any obstruction to the flow of water towards the scuppers, e.g. due to horizontal structures on deck, is to be avoided.
- (5) Water-spray system below hatch cover
- (A) Means are to be provided for effectively cooling under-deck cargo holds by at least 20 L/min per square metre of the horizontal area of cargo spaces by a fixed arrangement of spraying nozzles. Alternatively, equivalent water-mist systems may be considered on a case-by-case basis, based on suitable fire testing, to the satisfaction of the Society.
  - (B) The valve controls and pump controls necessary to activate the system are to be concentrated in the central control station.
  - (C) The system supply equipment and piping are to be located outside the protected cargo holds and all power supply components (including cables) are to be installed outside of the protected cargo holds.
  - (D) It is to be possible to supply each nozzle in any cargo hold from piping located on either side of the ship.
  - (E) The capacity of the system water supply is to be sufficient to feed the water-spray in any one cargo hold. The system may be fed by the fire pumps provided their capacity is in accordance with (3) (F).
  - (F) Isolating valves are to be provided to separate the section of the system located inside each cargo hold from the rest of the system. The isolating valves are to be located outside of the protected cargo hold and capable of remote release.
  - (G) Water supply to the system is to comply with one of the following.
    - (a) The system is to be supplied by the fire pumps and compliance with (3) (F) is to be ensured; or
    - (b) The system is to be fed by dedicated pumps and as a backup the main supply line of the system is to be connected to the fire main through a stop valve located as far as possible from the container cargo holds and cargo area on deck; or
    - (c) The system is to be provided with a redundant means of pumping. The capacity of the redundant means is to be sufficient to compensate for the loss of any single supply pump. Failure of any one component in the power and control system should not result in a reduction of required pump capacity by more than 50%. Switch over to redundant means of pumping may be manual or automatic.
  - (H) An international shore connection is to be available.
  - (I) The drainage system shall be sized to remove no less than 125 % of the combined capacity of both the water spraying system pumps and the required number of fire hose nozzles. The drainage system valves shall be operable from outside the protected space at a position in the vicinity of the extinguishing system controls. Bilge wells shall be of sufficient holding capacity and shall be arranged at the side shell of the ship at a distance from each other of not more than 40 m in each watertight compartment. If this is not possible, the adverse effect upon stability of the added weight and free surface of water shall be taken into account to the extent deemed necessary by the Society in its approval of the stability information.

- (J) For drainage system in which dangerous goods are intended to be carried, **Ch 12, 201. 5** of the Rules applies.
- (6) Water-spray system for the superstructure block
- (A) A fixed water-spraying system is to be installed to cover the exposed superstructure vertical boundaries facing container areas, except boundaries of the forecastle spaces, foundations of the monitors required in (4) and exposed lifeboats, liferafts and muster stations facing container areas.
- (B) When it is demonstrated an equivalent level of protection of the superstructure blocks, it may be accepted on a case-by-case basis by the Society.
- (C) The system is to be capable of covering the areas mentioned in (A) with a uniformly distributed water application rate of at least 10 L/min/m<sup>2</sup> for the largest projected horizontal surfaces and 4 L/min/m<sup>2</sup> for vertical surfaces.
- (D) The number and location of spray nozzles are to be suitable to spread the sprayed water uniformly on areas to be protected.
- (E) Water supply to the system is to comply with one of the following.
- (a) The system is to be supplied by the fire pumps and compliance with (3) (F) is to be ensured; or
- (b) The system is to be fed by dedicated pumps and as a backup the main supply line of the system is to be connected to the fire main through a stop valve located as far as possible from the container cargo holds and cargo area on deck; or
- (c) The system is to be provided with a redundant means of pumping. The capacity of the redundant means is to be sufficient to compensate for the loss of any single supply pump. Failure of any one component in the power and control system should not result in a reduction of required pump capacity by more than 50%. Switch over to redundant means of pumping may be manual or automatic.
- (F) The valve controls and pump controls necessary to activate the system are to be concentrated in the central control station.
- (7) Ventilation system
- (A) Separate and redundant means of air supply are to be provided for the accommodation spaces and control stations.
- (B) Air inlets of the sources of supply are to be arranged both at the front and at the aft of the superstructure blocks, so that the risk of both inlets drawing in smoke simultaneously is minimized in the event of a cargo fire. This requirement need not apply to forecastle spaces. Means of remotely closing each inlet are to be provided at the continuously manned central control station.
- (C) The ventilation openings located in the hatch covers are to be provided with quick closing devices. Power ventilation for the container cargo holds is to be fitted with controls so grouped that all fans serving one cargo hold may be stopped at once from the continuously manned central control station. It is to be possible to close all ventilation openings, except those located in the hatch covers, from the same location.

#### 4. AFC-C(3)

In addition to the requirements of **2** and **3**, ships assigned with the notation AFC-C(2) are to comply with this article.

(1) Portable fire-extinguishing equipment

In addition to the requirements of **2** (2), the portable fire-extinguishing equipment for stacked containers is to be able to reach the highest tier of containers, and is to be capable of spraying water inside a confined space when connected to the fire main and raised at this level.

(2) Fire-fighter's outfits

In addition to the requirements of **2** (3), four fire-fighter's outfits and two spare charges are to be provided for each required breathing apparatus.

(3) Fire detection

(A) Means are to be provided in the cargo holds to detect and locate heating cargo or a cargo fire at an early stage and identify the container or containers where the seat of the fire or thermal reaction is located. An audible and visual alarm is to be triggered in case of the temperature exceeds the temperature setting. In case of the device to be used in hazardous area, it shall be of a certified type. The efficiency and reliability of the system are to be documented to the satisfaction of the Society.

(B) Means are to be provided to detect a cargo fire on deck. For this purpose, innovative sol-

utions may be considered, such as: thermal imaging cameras, flame detection systems, video-based fire detection, linear heat detection, where the seat of the fire or thermal reaction is located. An audible and visual alarm is to be triggered in case of the temperature exceeds the temperature setting. The efficiency and reliability of the system are to be documented to the satisfaction of the Society.

## 5. AFC-C(FSC)

### (1) Application

(A) The FSC notation recognizes Container Carriers that are provided with specific arrangements to flood individual container holds for the purpose of extinguishing a fire in a container hold and for the dewatering thereafter.

(B) The arrangements and procedures are to permit only one (1) single container hold to be flooded at any time. Multiple holds are not to be flooded and the same is to be clearly posted at any controls associated with the arrangements.

### (2) Machinery and Piping

Pumps, piping, materials and any electrical systems are to be in accordance with the applicable requirements of **Rules for the Classification of Steel Ships**.

### (3) Controls

Controls for the filling and dewatering of the container holds are to comply with the following:

(A) Be located in a position that would be readily accessible during a fire in the container holds.

(B) Not to be rendered ineffective by the heat of a container hold fire.

(C) Flooding and discharge valves are to be provided with valve position indicators.

(D) The components, cabling, etc., of control system are to comply with any applicable requirements in **Pt 6 of Rules**.

### (4) Water Level Indication

(A) Each container hold is to be provided with the means to identify the level of the water in the container hold.

(B) The water level indicator is to be provided at the same location as the controls.

(C) An audible and visual alarm is to be activated at the same location as the controls when water has been detected in a container hold. A means to manually silence the audible portion of the alarm may be provided.

(D) An audible and visual alarm is to be activated at the same location as the controls where the water level exceeds the elevation of the main deck.

(E) Means to monitor the water level in the duct keel is to be provided.

(F) An audible and visual alarm is to be activated at the same location as the controls when water has been detected in the duct keel.

### (5) Container Hold Filling Arrangements

(A) Every vessel is to be provided with the arrangements necessary to safely fill each container hold with sea water.

(B) The arrangements are to be capable of filling the largest container hold within twenty-four (24) hours assuming 10% of the volume of the container hold is filled with containers. Each container is assumed to have a 0.7 permeability rate. Calculations verifying the same are to be submitted.

(C) Filling arrangements for the container holds may consist of either portable or fixed arrangements. Further, the arrangements may be either a fixed filling arrangement using pumps or a combination of flooding and filling arrangements using pumps and are to comply with the following.

#### (a) Fixed Filling Arrangements Using Pumps

(i) Any filling arrangement using pumps is to be independent of the bilge system.

(ii) The filling arrangements may be led from the firemain and/or the ballast system provided the arrangement complies with the following:

- A branch pipe is to be provided for each individual container hold.

- The connection between the main and the branches are to be located outside the machinery space.

- Each branch line is to be fitted with a positive closing valve as well as a temporary connection arrangement (normally removed spool piece w/ blank flanges) where the branch leaves the main.

- There is to be a remote operated positive closing valve fitted at the point where the piping enters the container hold and the valve as well as the controls are not

- to be rendered ineffective by heat from a fire within the container hold served.
- No piping that is connected to a container hold carrying dangerous goods with toxic or flammable properties is to be routed through or connected to piping from any other container hold.
- (b) Gravity Flooding Arrangements
    - Piping arrangements for gravity flooding of a container hold will be subject to special consideration.
  - (c) Other filling arrangements will be specially considered.
- (6) Dewatering Arrangements for Container Holds
- (A) A fixed piping arrangement to dewater each of the container holds is to be provided.
  - (B) The dewatering may be performed by eductors supplied from the ballast system or the fire main system. Where the eductors are supplied from the fire main, the fire pumps are to have sufficient capacity to simultaneously supply all required firefighting services as well as the eductors of any two adjacent holds.
  - (C) Arrangements are to be provided to safely discharge any contaminated water to another vessel or treatment facility.
  - (D) Other arrangements will be subject to special consideration.
- (7) Prevention of Progressive Flooding
- (A) Arrangements are to be provided to prevent water from a flooded container hold cannot pass to any other location on the vessel during and after a container hold fire.
  - (B) Any opening or interconnection within a container hold at an elevation that when the container hold is flooded could allow water to pass to another space of the vessel is to be fitted with adequate means of isolation.
  - (C) In addition to any other requirements, arrangements or devices intended to prevent progressive flooding such as access hatches, penetration arrangements, valves in interconnecting piping systems, etc., are to comply with the following:
    - (a) Not to be rendered ineffective by heat.
    - (b) Capable of maintaining its watertight integrity when exposed to the maximum head of water that may exist from either side of the device.
- (8) Dangerous Goods
- Where a container hold is designated to carry Class 4.3 Dangerous Goods or any other cargo that is known to react hazardously with water, notification of the hazard is to be posted in location of the controls to flood the hold.
- (9) Vessel Structural Integrity
- The hull structure of the vessel is to be evaluated in accordance with **Pt 14 Annex 14–1** of the **Rules** with any one container cargo hold completely or partially flooded while in any operational condition. ↓

Rules for the Classification of Steel Ships  
Guidance Relating to the Rules for the Classification  
of Steel Ships

---

---

## PART 8 FIRE PROTECTION AND FIRE EXTINCTION

Published by

**KR**

36, Myeongji ocean city 9-ro, Gangseo-gu,  
BUSAN, KOREA

TEL : +82 70 8799 7114

FAX : +82 70 8799 8999

Website : <http://www.krs.co.kr>

---

---

Copyright© 2024, **KR**

Reproduction of this Rules and Guidance in whole or in  
parts is prohibited without permission of the publisher.